

1:	10.2	↑
2:	*10.6	↓
3:	*10.8	↗
4:	10.4	←
5:	10.3	↘
6:	9.7	←
7:	10.2	↘
8:	10.2	↘
Serie		79.0
Total		0.0

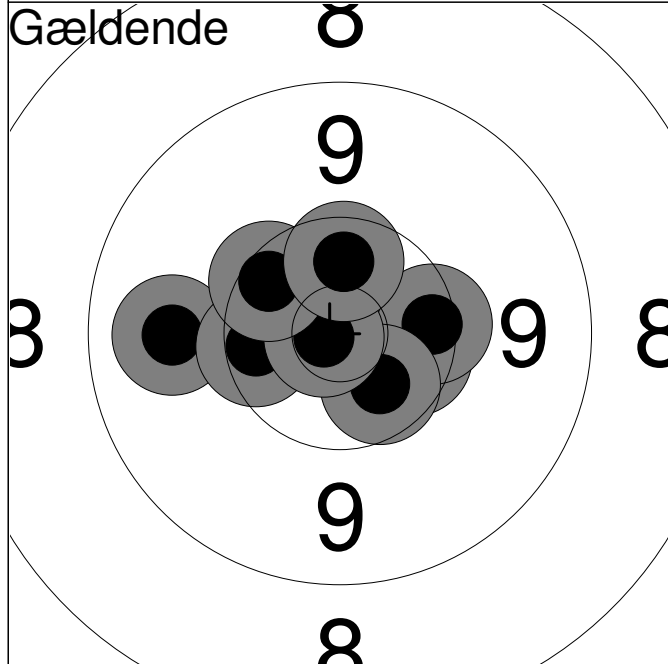

1:	9.8	←
2:	*10.8	↑
3:	10.4	←
4:	*10.4	→
5:	10.3	→
6:	*10.6	↗
7:	*10.5	↘
8:	*10.8	←
9:	10.3	↗
10:	*10.5	↑
Serie		99.0
Total		99.0

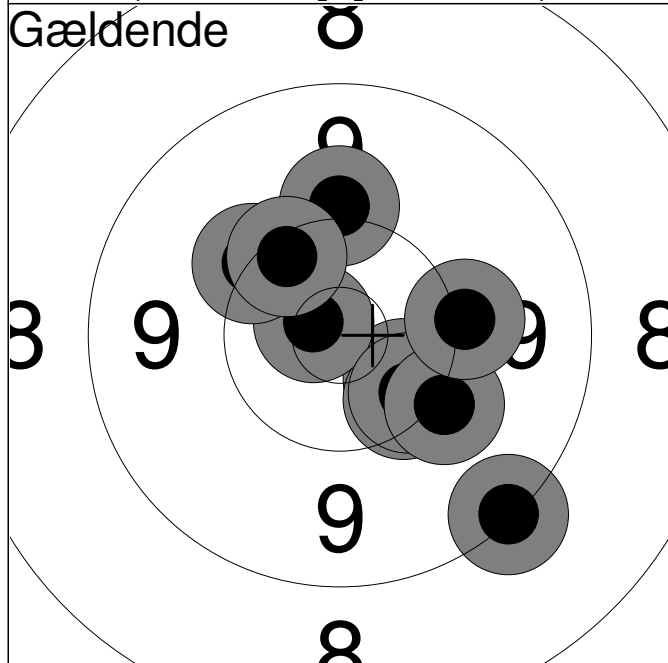

11:	*10.4	↘
12:	10.3	↘
13:	*10.7	↗
14:	9.2	↘
15:	10.3	↘
16:	10.2	↗
17:	10.1	↘
18:	10.1	↑
19:	10.1	→
20:	10.3	↗
Serie		99.0
Total		198.0

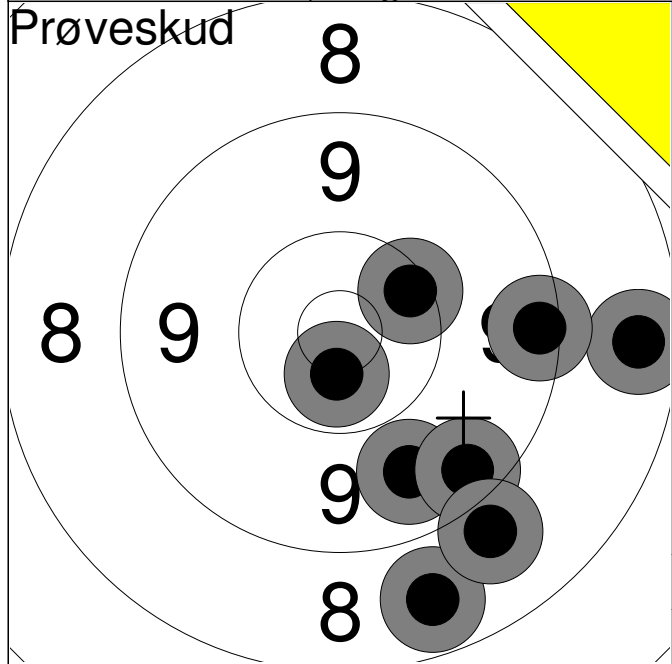

1:	9.7	↓
2:	8.5	→
3:	9.3	→
4:	8.6	↓
5:	9.4	↓
6:	8.9	↓
7:	10.3	↗
8:	*10.6	↓
Serie		71.0
Total		0.0

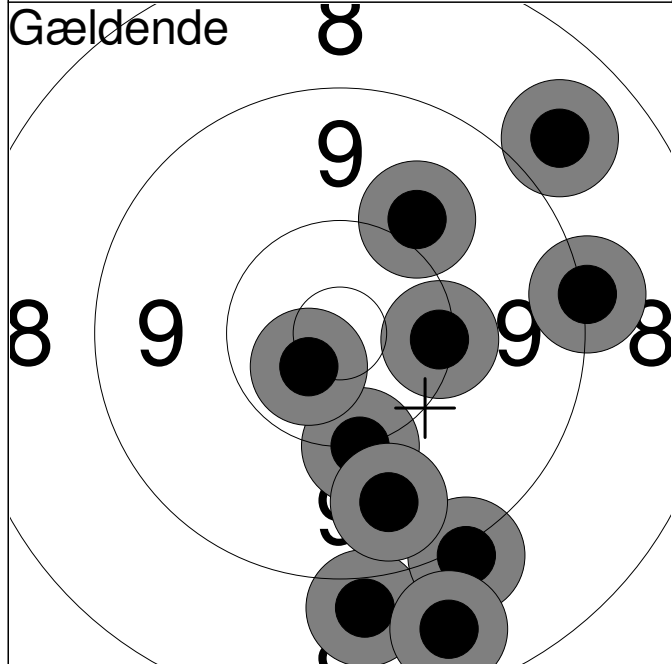

1:	8.9	↓
2:	9.1	→
3:	9.1	↓
4:	10.0	↗
5:	10.2	↓
6:	8.6	↓
7:	10.2	→
8:	8.8	↗
9:	*10.6	↙
10:	9.7	↓
Serie		91.0
Total		91.0

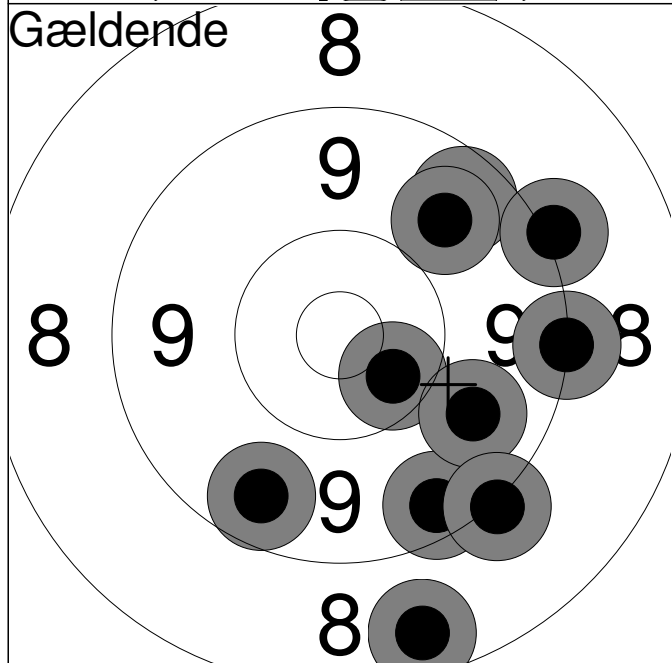

11:	9.4	↓
12:	*10.4	↓
13:	9.5	↗
14:	8.5	↓
15:	9.1	↗
16:	9.8	↓
17:	9.8	↗
18:	9.2	→
19:	9.6	↓
20:	9.1	↓
Serie		90.0
Total		181.0

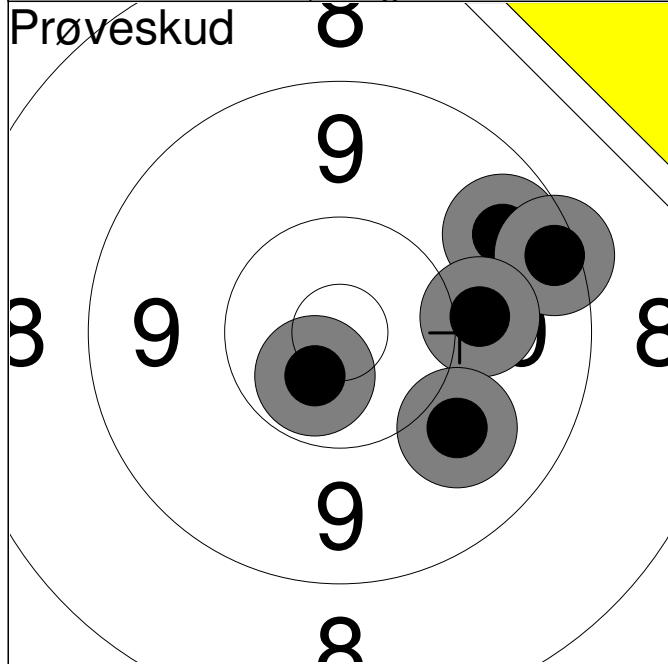

1:	9.6	↗
2:	9.3	→
3:	*10.6	↘
4:	10.0	→
5:	9.9	↘
Serie		47.0
Total		0.0

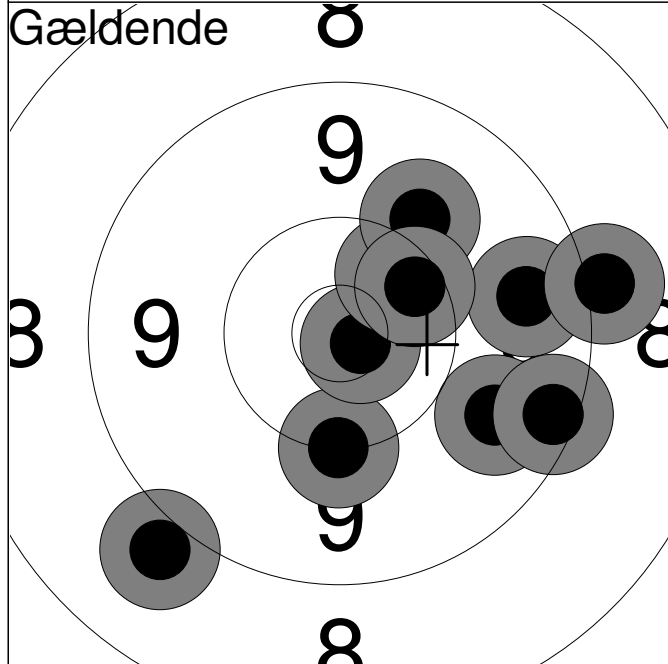

1:	9.0	↘
2:	9.7	↘
3:	10.2	↓
4:	*10.8	↘
5:	9.6	→
6:	10.4	↗
7:	10.0	↗
8:	9.3	↘
9:	9.0	→
10:	10.3	↗
Serie		95.0
Total		95.0

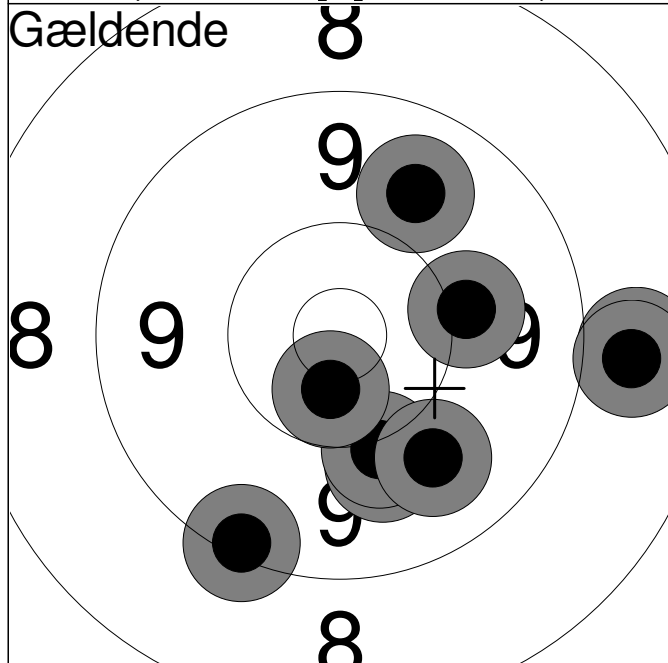

11:	9.3	↘
12:	10.0	↘
13:	8.8	→
14:	10.1	↘
15:	8.8	→
16:	*10.6	↘
17:	10.0	→
18:	9.9	↘
19:	9.8	↗
Serie		83.0
Total		178.0

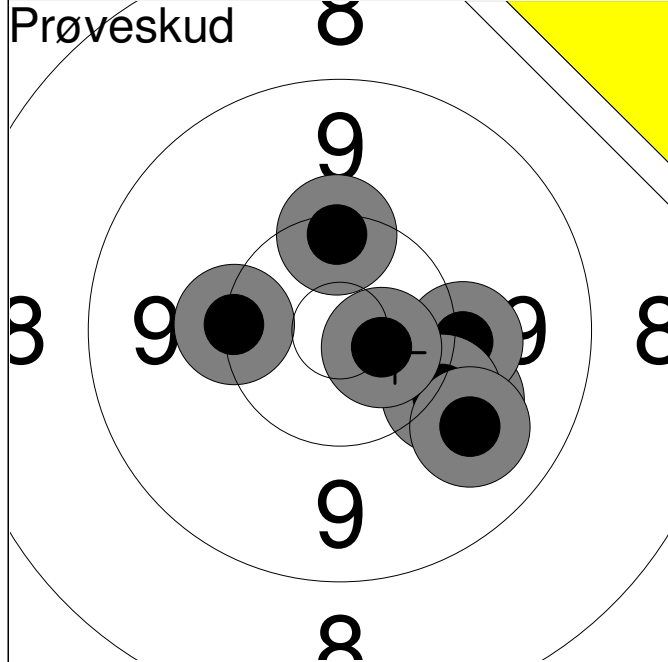

1:	10.0	↘
2:	10.1	→
3:	10.1	↘
4:	10.2	←
5:	9.8	↘
6:	*10.6	→
7:	10.3	↑
Serie		69.0
Total		0.0

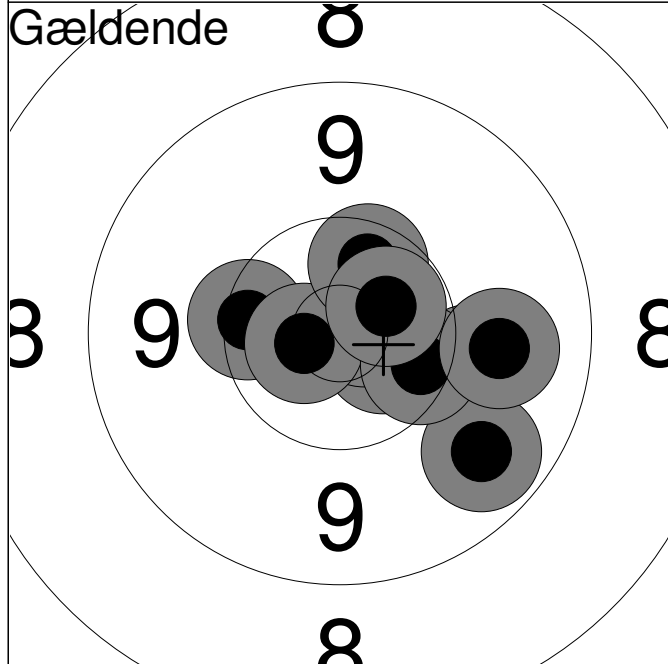

1:	*10.6	↘
2:	10.3	←
3:	10.0	→
4:	*10.8	→
5:	*10.7	←
6:	*10.4	↑
7:	9.7	↘
8:	10.4	↘
9:	9.8	→
10:	*10.6	↗
Serie		98.0
Total		98.0

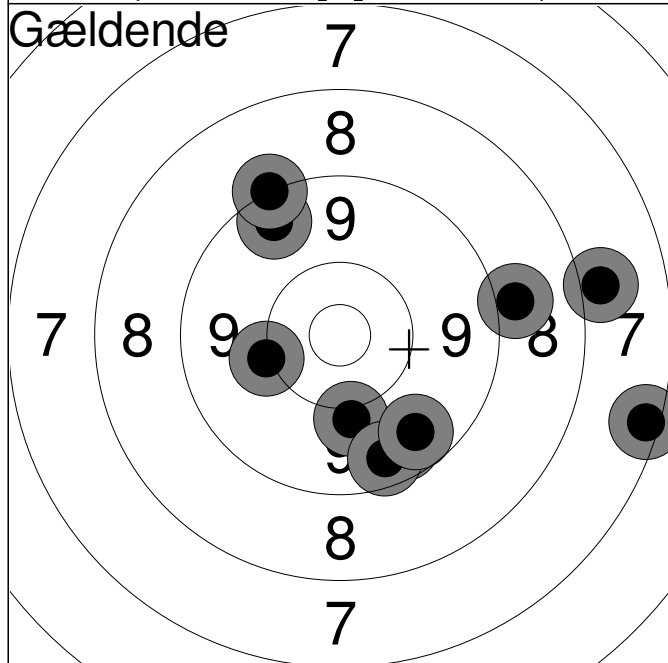

11:	7.3	→
12:	9.6	↘
13:	9.5	↗
14:	10.0	↘
15:	9.5	↘
16:	7.9	→
17:	9.0	→
18:	10.1	←
19:	9.6	↘
20:	9.2	↗
Serie		88.0
Total		186.0

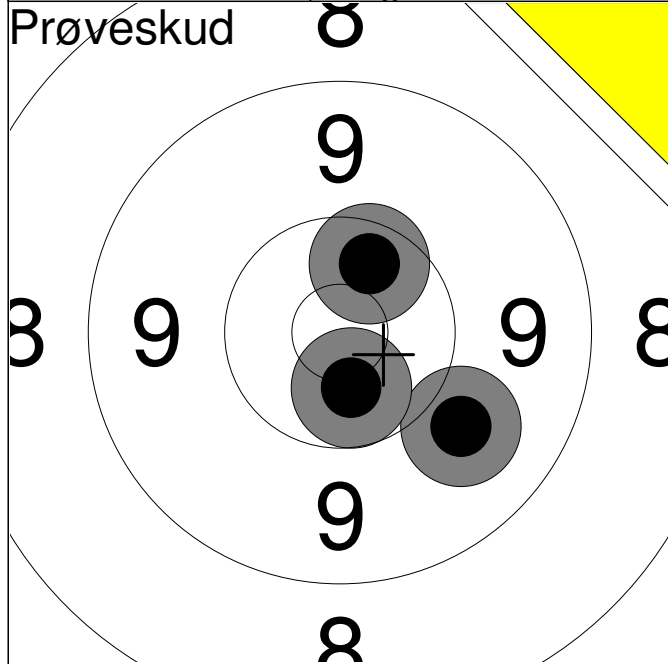

1:	*10.4	↗
2:	9.9	↘
3:	*10.6	↙
Serie		29.0
Total		0.0

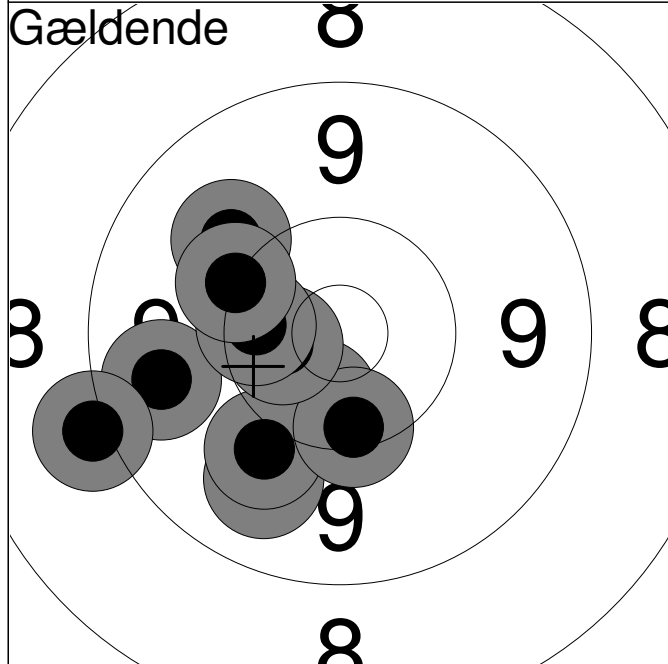

1:	*10.5	↘
2:	9.8	↘
3:	10.0	↘
4:	10.3	↘
5:	9.7	←
6:	9.1	←
7:	*10.6	←
8:	10.0	↗
9:	10.4	←
10:	10.2	↗
Serie		97.0
Total		97.0

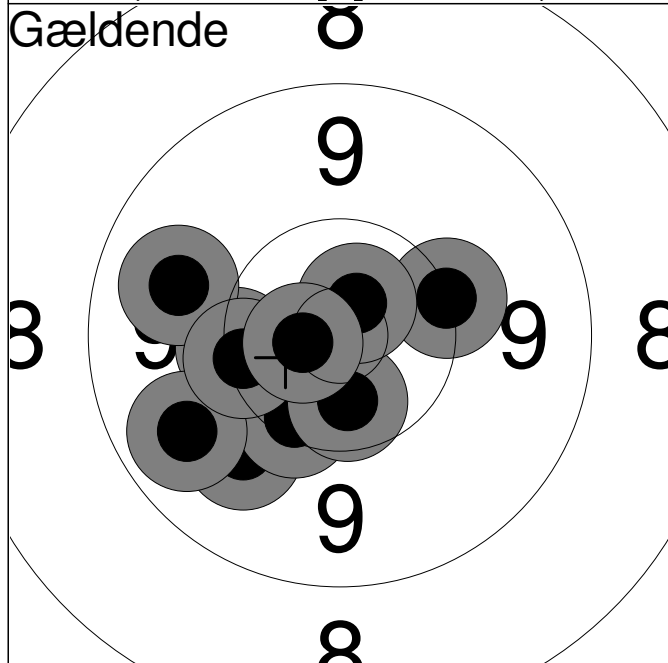

11:	10.2	←
12:	9.9	↘
13:	9.8	←
14:	10.3	↘
15:	*10.5	↘
16:	10.2	→
17:	*10.7	↗
18:	9.7	←
19:	10.3	←
20:	*10.7	←
Serie		97.0
Total		194.0

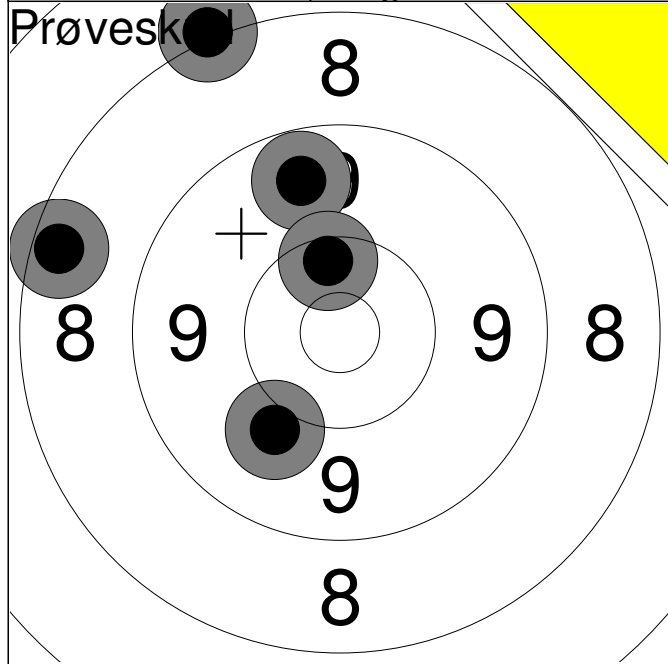

1:	8.1	↗
2:	9.6	↗
3:	10.0	↘
4:	8.4	↖
5:	10.3	↗
Serie		45.0
Total		0.0

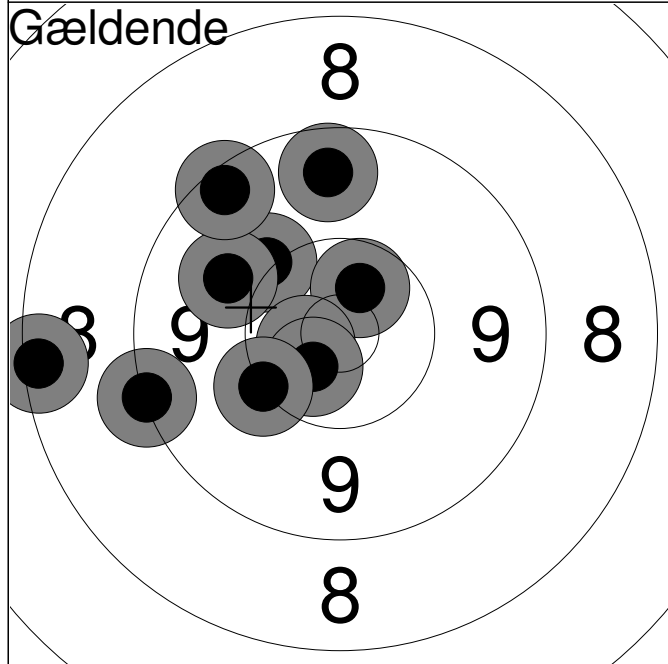

1:	10.1	↖
2:	*10.5	↗
3:	*10.6	↖
4:	8.3	↖
5:	*10.6	↘
6:	9.9	↖
7:	9.4	↗
8:	9.6	↗
9:	9.2	↖
10:	10.2	↘
Serie		94.0
Total		94.0

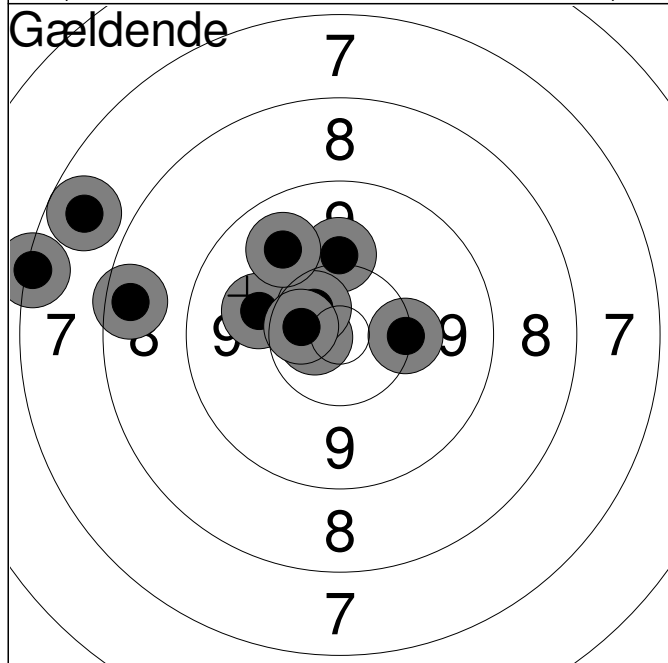

11:	7.6	↖
12:	10.1	↗
13:	10.0	↖
14:	*10.7	↖
15:	*10.5	↗
16:	*10.5	↖
17:	9.8	↗
18:	7.3	↖
19:	10.2	→
20:	8.5	↖
Serie		91.0
Total		185.0

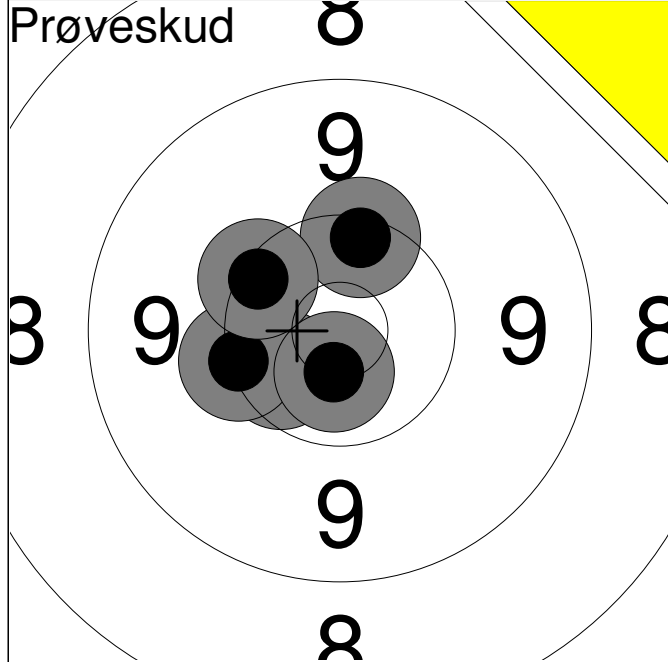

1:	10.3	↑
2:	*10.5	↙
3:	10.2	↙
4:	*10.7	↓
5:	10.3	↖
Serie		50.0
Total		0.0

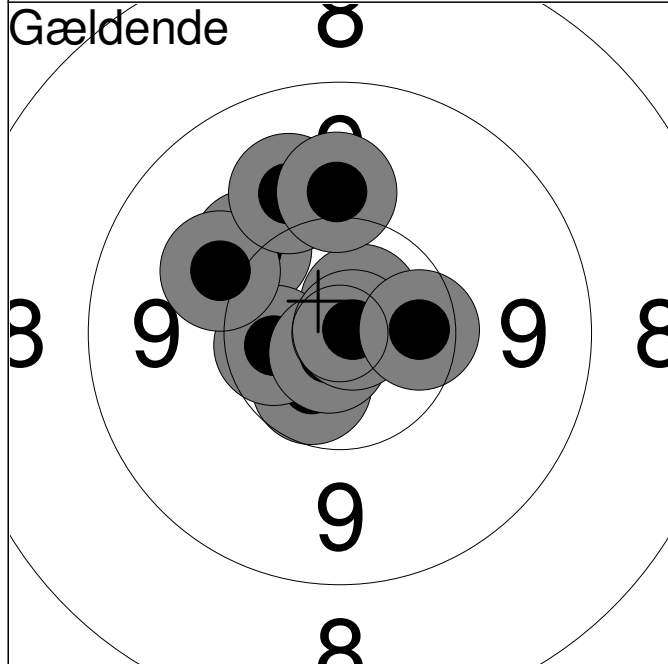

1:	10.1	↖
2:	*10.6	↙
3:	*10.7	↗
4:	*10.5	↙
5:	10.0	↖
6:	*10.8	↙
7:	*10.9	→
8:	10.4	→
9:	9.9	↑
10:	10.0	↑
Serie		99.0
Total		99.0

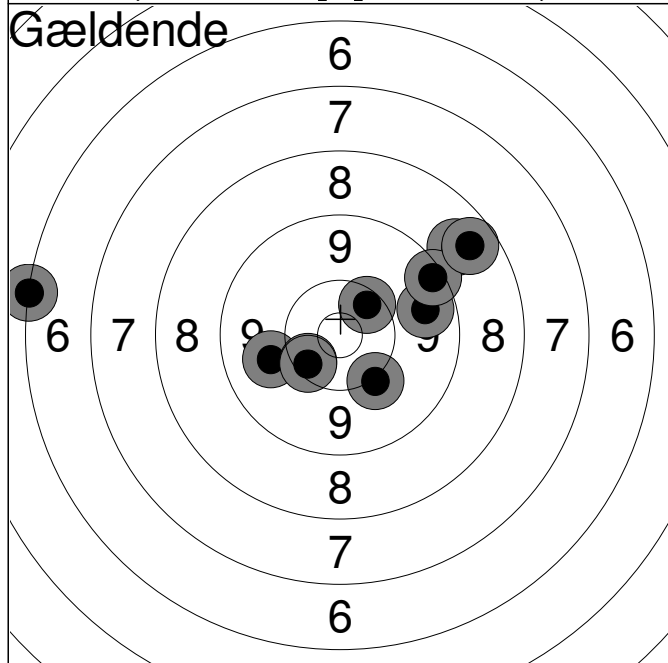

11:	9.9	↙
12:	6.2	↙
13:	10.1	↙
14:	9.6	→
15:	10.4	↙
16:	8.8	↗
17:	10.3	↙
18:	9.3	↗
19:	8.6	↗
20:	10.4	↗
Serie		89.0
Total		188.0

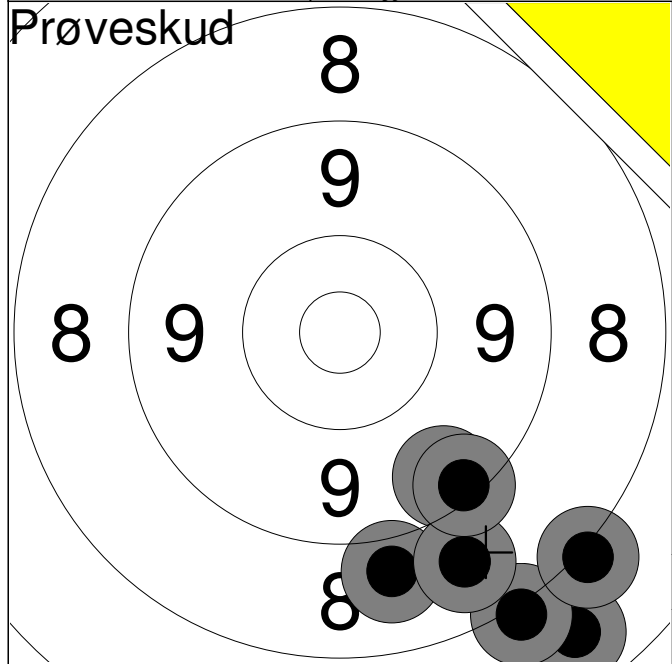

1:	8.9	↘
2:	7.7	↘
3:	8.1	↘
4:	9.5	↘
5:	8.1	↘
6:	8.7	↘
7:	9.3	↘
Serie		57.0
Total		0.0

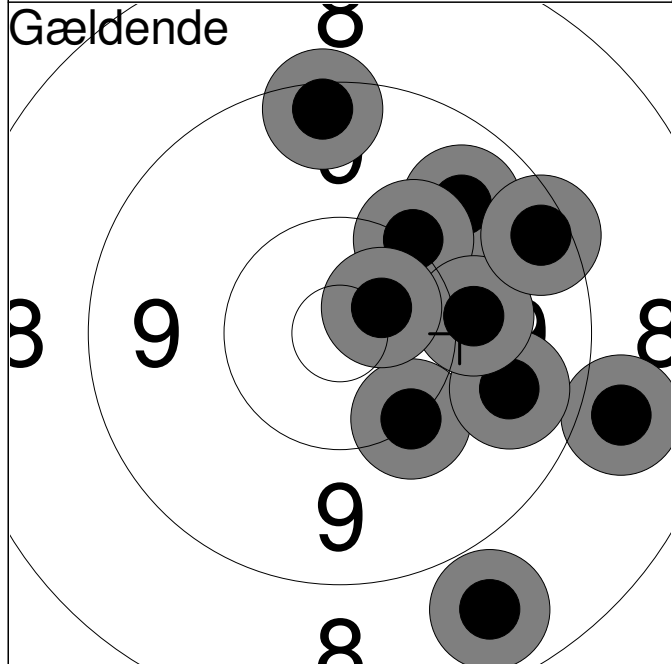

1:	8.9	→
2:	8.7	↘
3:	10.2	↘
4:	9.7	→
5:	9.7	↗
6:	10.1	↗
7:	10.0	→
8:	9.4	↑
9:	9.4	↗
10:	*10.6	↗
Serie		92.0
Total		92.0

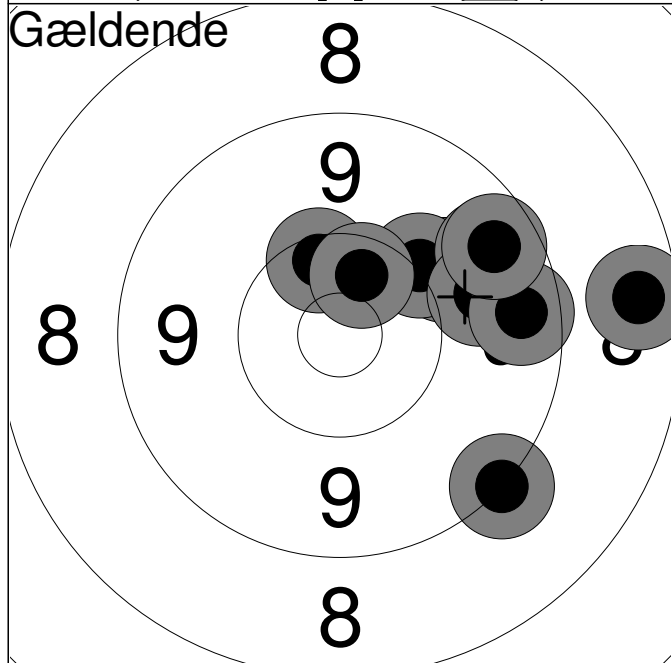

11:	10.0	↗
12:	9.2	↘
13:	10.1	↗
14:	9.6	↗
15:	10.4	↑
16:	8.5	→
17:	*10.5	↑
18:	9.8	→
19:	9.5	→
20:	9.5	↗
Serie		93.0
Total		185.0

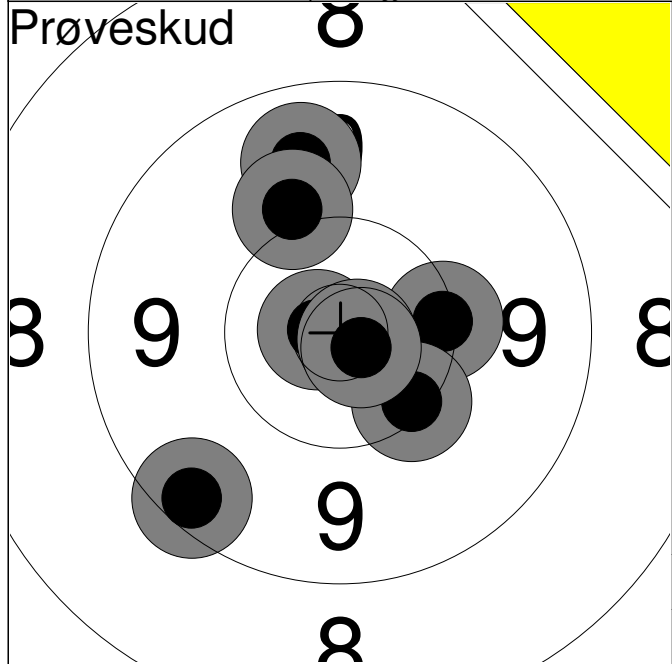

1:	10.2	→
2:	9.4	↙
3:	9.7	↑
4:	10.3	↘
5:	*10.8	←
6:	*10.8	↘
7:	10.0	↑
8:	*10.8	↘
Serie		78.0
Total		0.0

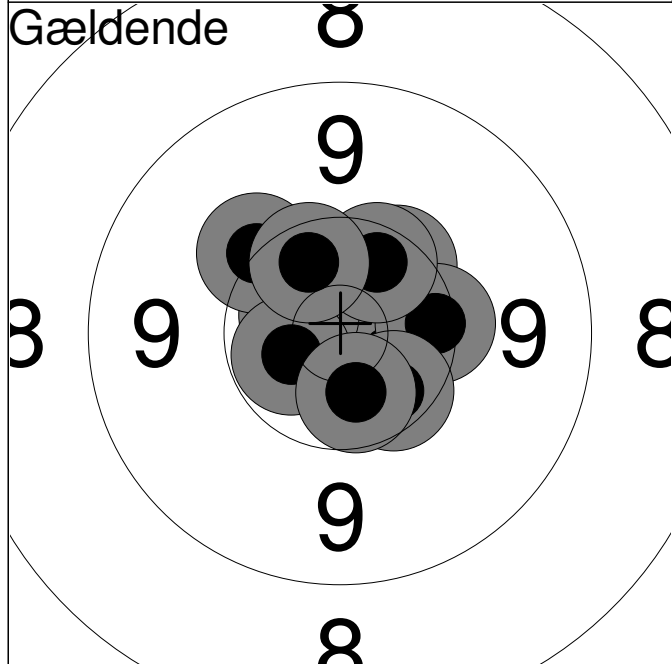

1:	*10.6	↘
2:	*10.6	↖
3:	10.3	↗
4:	10.2	↗
5:	*10.6	↙
6:	10.3	→
7:	10.4	↘
8:	10.4	↗
9:	*10.5	↘
10:	*10.4	↗
Serie		100.0
Total		100.0

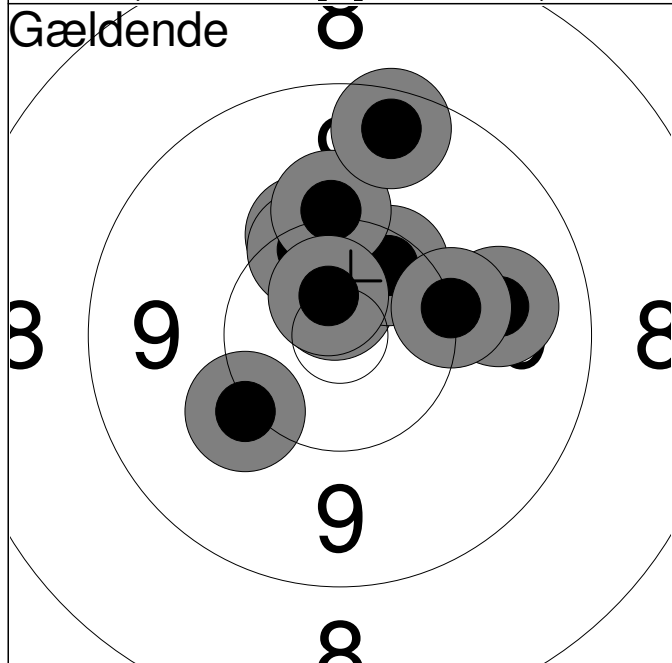

11:	*10.7	↑
12:	10.1	↙
13:	10.4	↗
14:	10.2	↑
15:	10.3	↑
16:	10.1	↑
17:	9.5	↑
18:	9.8	→
19:	*10.7	↑
20:	10.2	→
Serie		98.0
Total		198.0

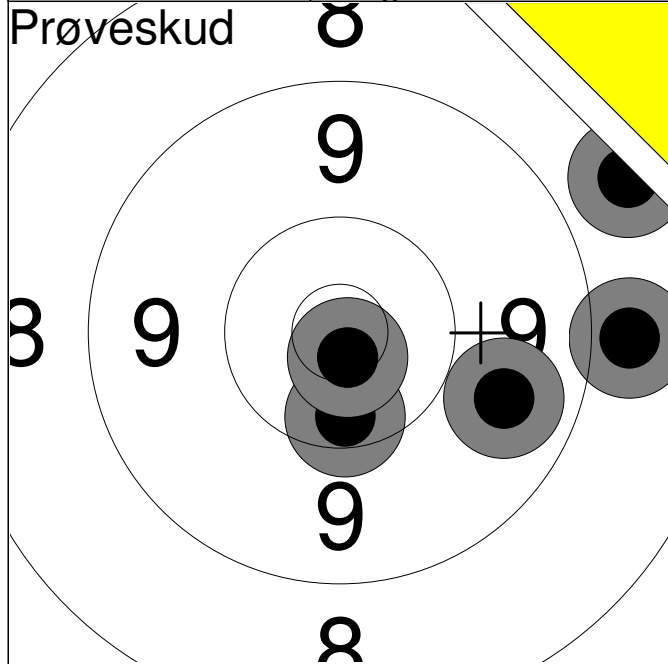

1:	10.4	↓
2:	8.9	→
3:	9.7	↘
4:	*10.8	↓
5:	8.6	↗
Serie		45.0
Total		0.0

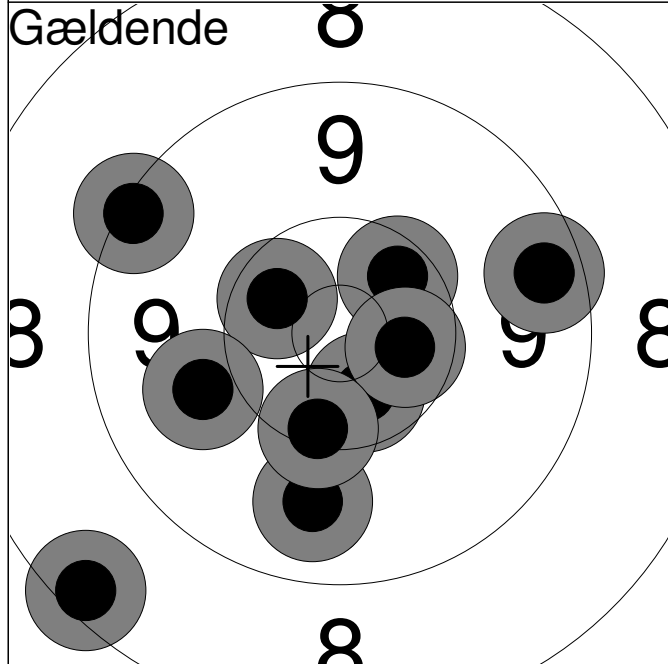

1:	9.8	↓
2:	8.4	↙
3:	*10.5	↗
4:	9.3	↖
5:	9.5	→
6:	9.9	←
7:	*10.5	↓
8:	10.4	↗
9:	*10.5	→
10:	10.3	↓
Serie		94.0
Total		94.0

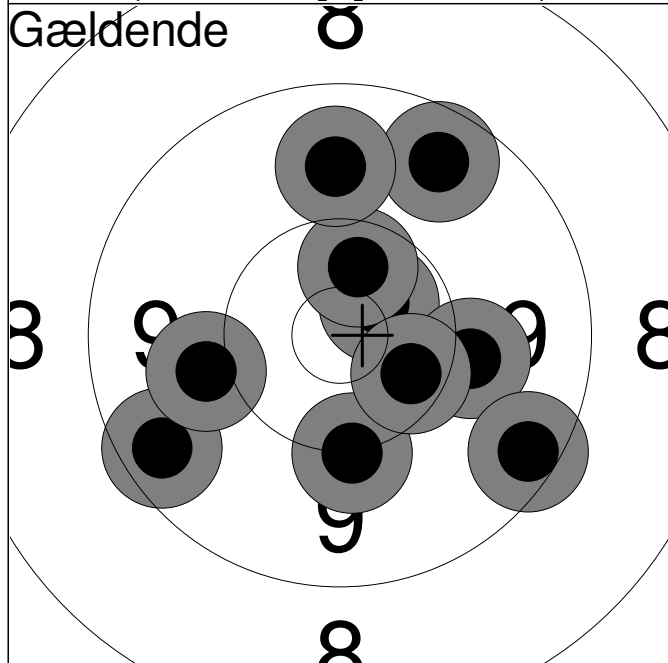

11:	*10.6	↗
12:	*10.5	↑
13:	10.1	↓
14:	9.6	↗
15:	10.0	→
16:	9.4	↘
17:	9.8	↑
18:	9.5	↙
19:	10.0	←
20:	10.4	↘
Serie		96.0
Total		190.0

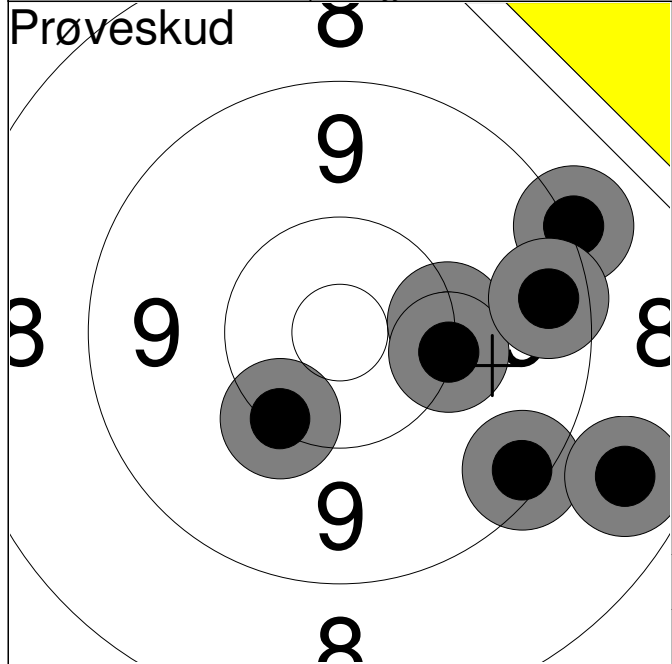

1:	9.1	→
2:	9.3	↘
3:	10.2	↙
4:	10.2	→
5:	8.7	↘
6:	10.2	→
7:	9.5	→
Serie		65.0
Total		0.0

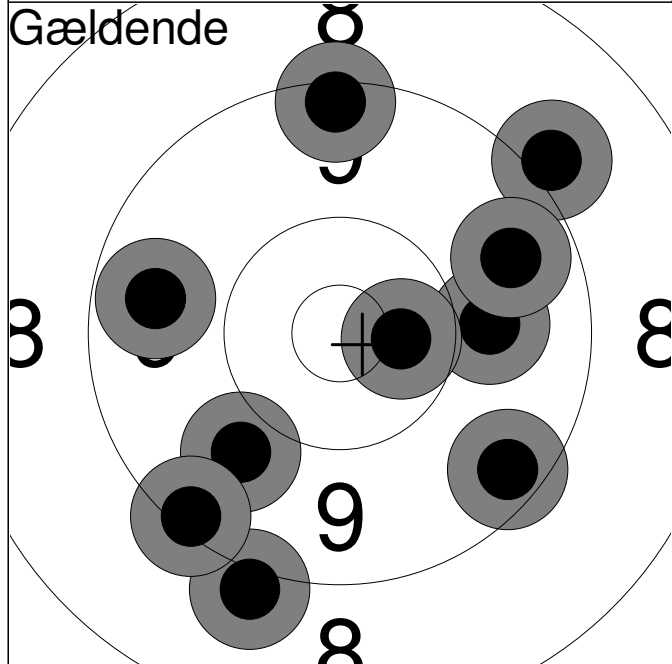

1:	9.6	←
2:	9.9	→
3:	*10.5	→
4:	9.0	↗
5:	9.0	↘
6:	9.3	↑
7:	9.7	→
8:	9.9	↙
9:	9.3	↙
10:	9.4	↘
Serie		91.0
Total		91.0

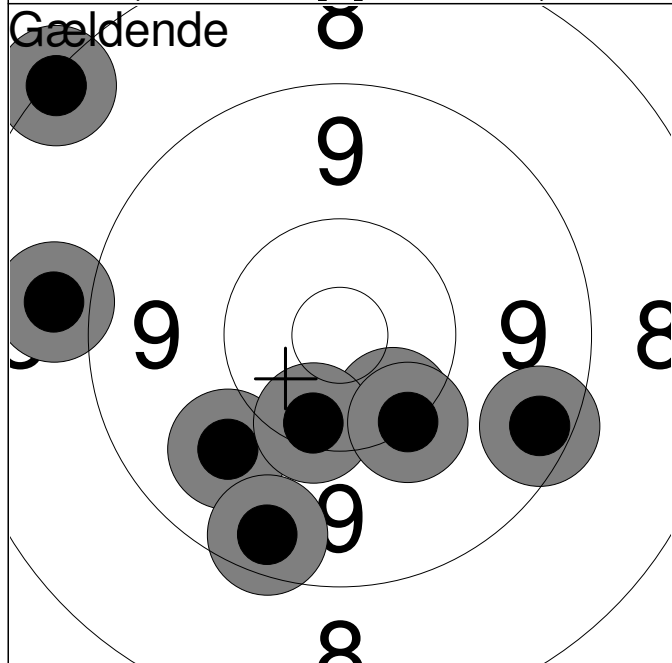

11:	8.9	←
12:	9.4	→
13:	8.2	↗
14:	10.3	↘
15:	9.8	↙
16:	10.3	↘
17:	10.2	↘
18:	9.5	↘
Serie		73.0
Total		164.0

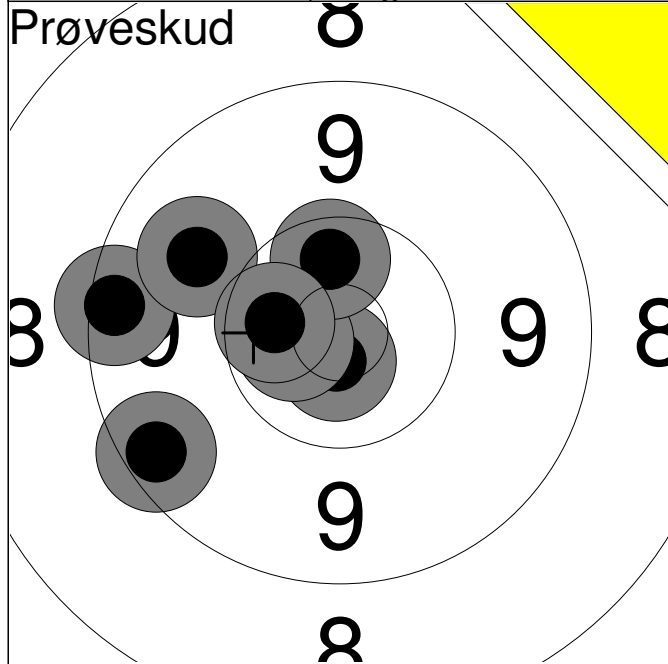

1:	9.4	↙
2:	9.4	↙
3:	*10.8	↓
4:	9.8	↗
5:	*10.6	↙
6:	*10.4	↑
7:	*10.5	↙
Serie		67.0
Total		0.0

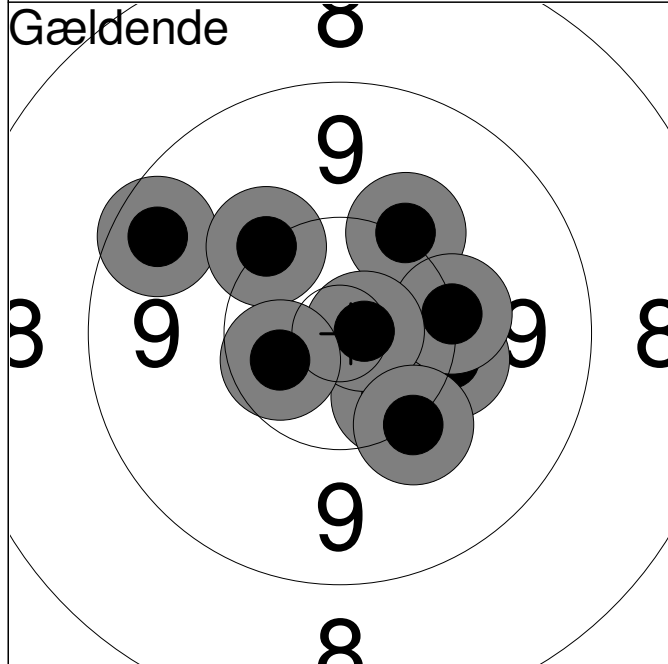

1:	10.4	→
2:	10.4	↘
3:	10.1	↗
4:	10.2	→
5:	9.5	↗
6:	10.2	→
7:	*10.8	→
8:	10.1	↘
9:	10.2	↗
10:	*10.5	↙
Serie		99.0
Total		99.0

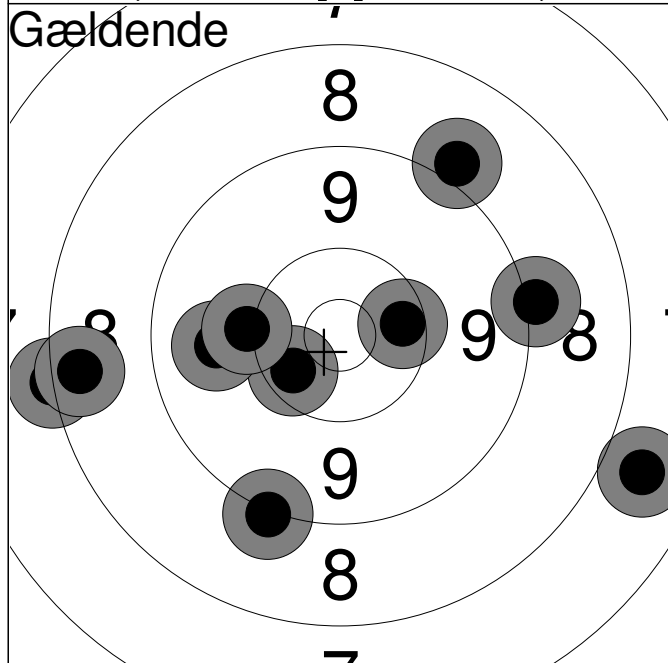

11:	7.8	→
12:	9.1	↘
13:	9.1	→
14:	10.4	→
15:	8.2	↙
16:	9.0	↗
17:	*10.4	↙
18:	9.8	↙
19:	10.1	↙
20:	8.5	↙
Serie		89.0
Total		188.0

Hold 53	Skive 6	Nikolai Vinter Mørk	
-------------------	-------------------	----------------------------	--

50m	Hjørring Skytteforening	MB2	
-----	-------------------------	-----	--

	Nordjysk Mesterskab 2013	Aalborg Skyttekreds	
--	--------------------------	---------------------	--

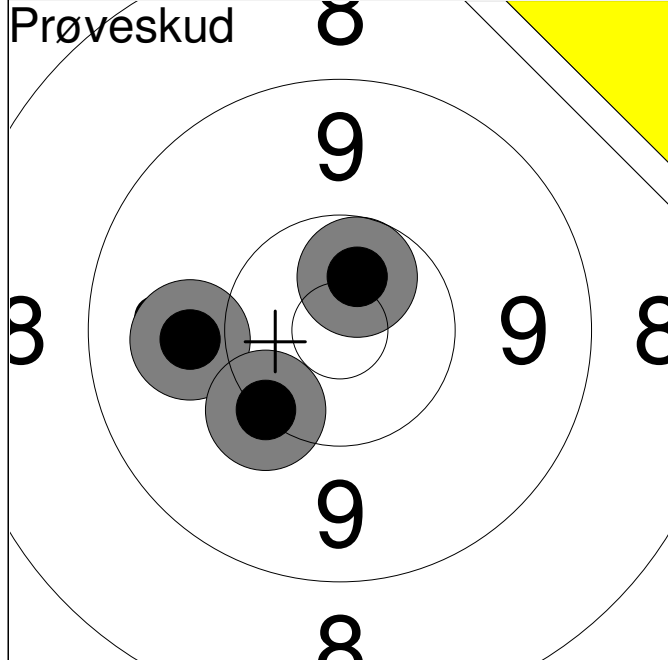

1:	*10.6	↑
2:	9.9	←
3:	10.2	↙
Serie		29.0
Total		0.0

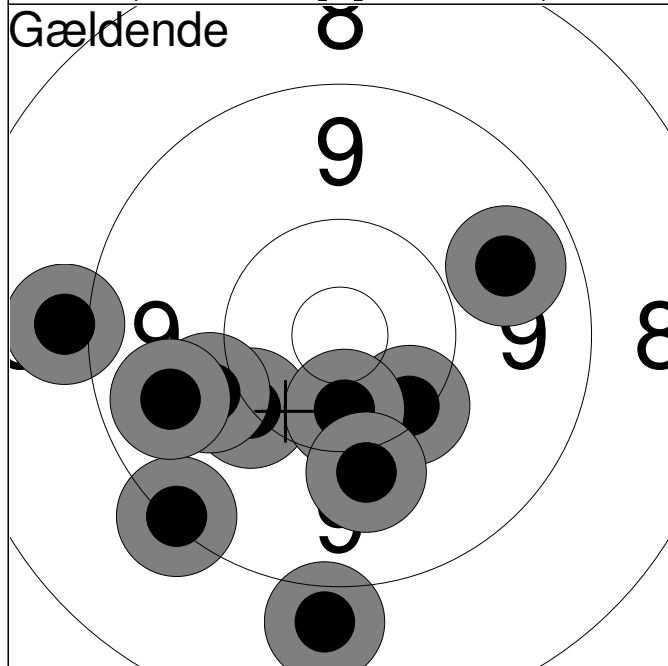

1:	9.2	↙
2:	10.3	↘
3:	10.2	↙
4:	*10.4	↓
5:	10.0	↓
6:	10.0	←
7:	9.0	←
8:	9.7	←
9:	9.7	→
10:	8.9	↓
Serie		94.0
Total		94.0

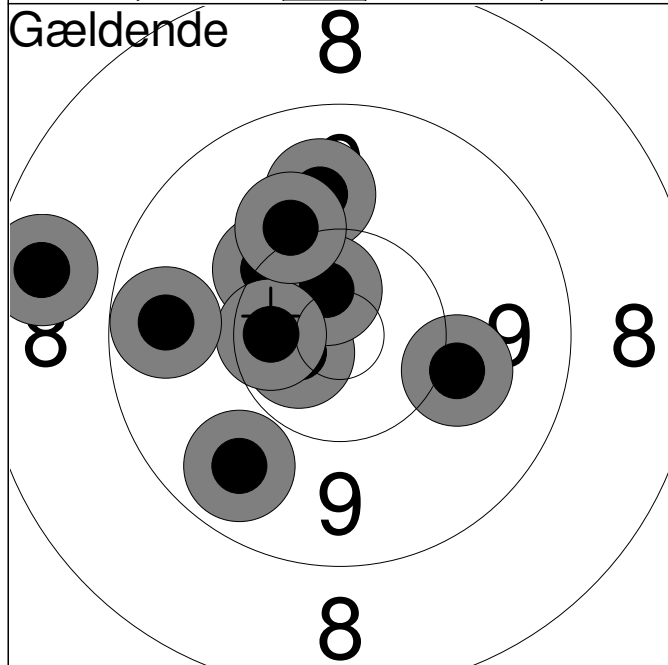

11:	8.6	←
12:	*10.6	←
13:	9.7	↙
14:	10.2	↗
15:	9.9	↑
16:	*10.6	↑
17:	*10.4	←
18:	10.0	→
19:	10.1	↗
20:	9.6	←
Serie		95.0
Total		189.0

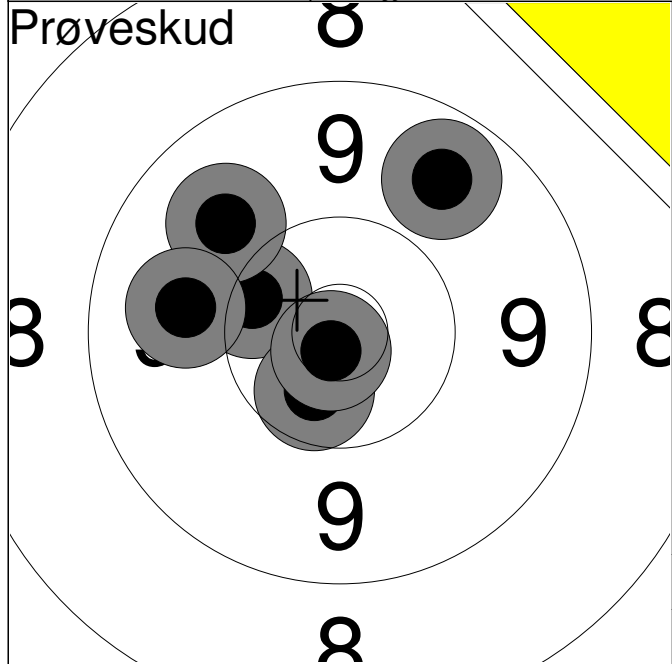

1:	9.7	↗
2:	10.3	↖
3:	9.9	↗
4:	9.9	↖
5:	*10.5	↘
6:	*10.8	↘
Serie		57.0
Total		0.0

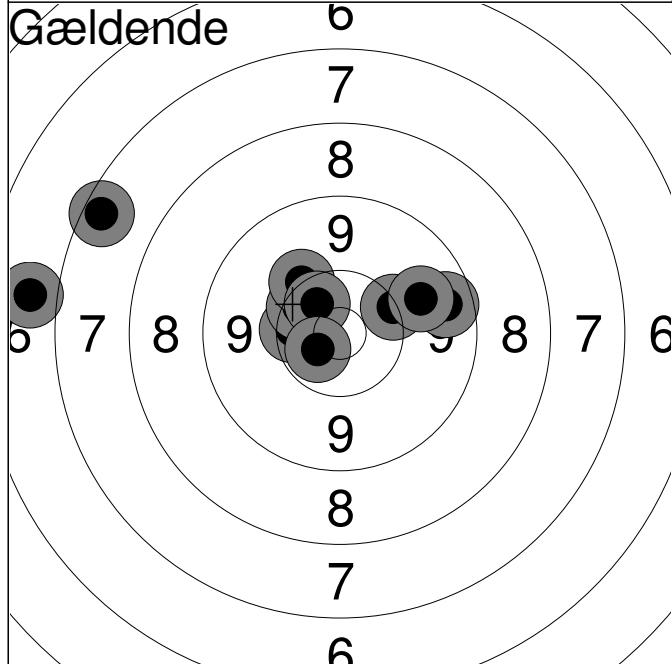

1:	10.4	←
2:	6.8	←
3:	10.2	↗
4:	9.5	→
5:	10.3	↗
6:	10.2	↗
7:	*10.5	↗
8:	7.4	↗
9:	*10.6	↘
10:	9.8	↗
Serie		91.0
Total		91.0

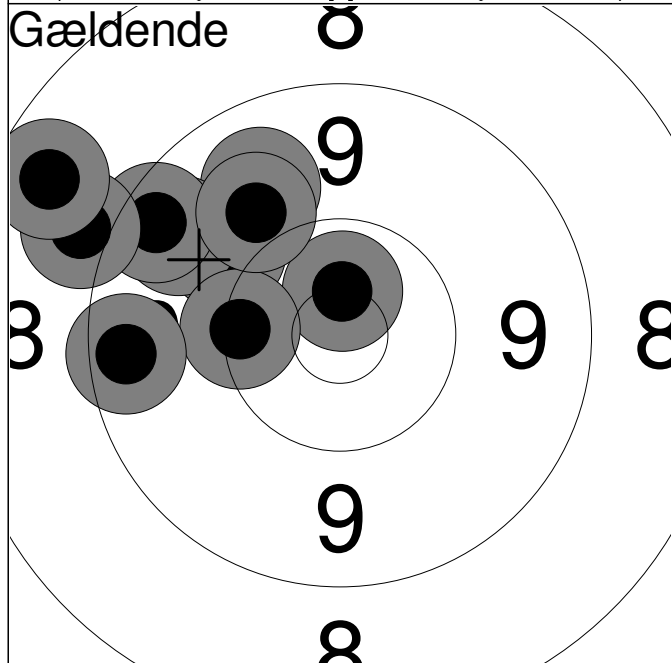

11:	10.0	↗
12:	9.8	↗
13:	9.6	↗
14:	*10.7	↑
15:	9.4	↗
16:	9.0	↗
17:	10.3	←
18:	8.6	↗
19:	9.9	↗
20:	9.4	←
Serie		92.0
Total		183.0

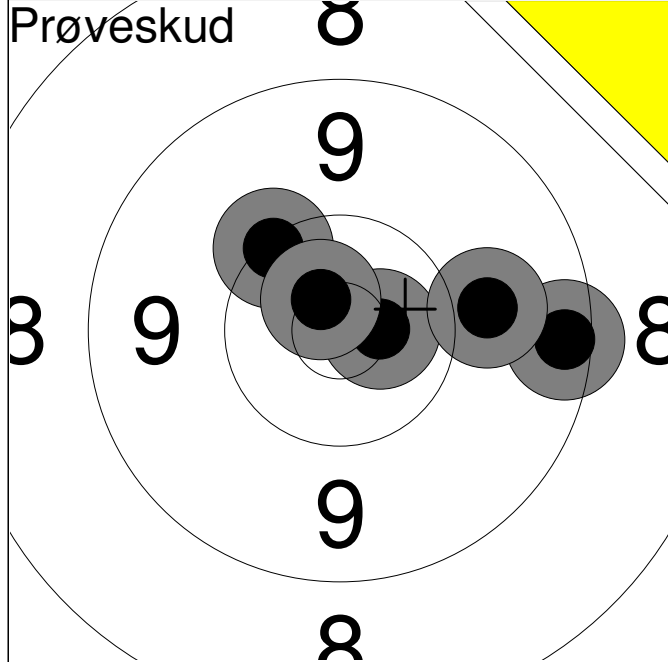

1:	9.4	→
2:	*10.7	→
3:	9.9	→
4:	10.2	↗
5:	*10.7	↗
Serie		48.0
Total		0.0

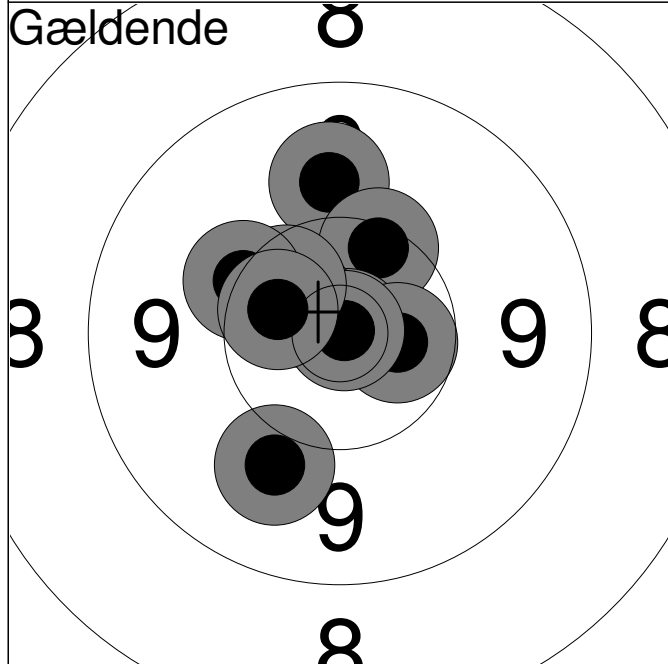

1:	9.9	↑
2:	10.3	↗
3:	*10.9	↗
4:	*10.6	→
5:	*10.6	↗
6:	*10.9	↗
7:	*10.5	↗
8:	10.2	↗
9:	9.9	↘
10:	*10.5	↖
Serie		98.0
Total		98.0

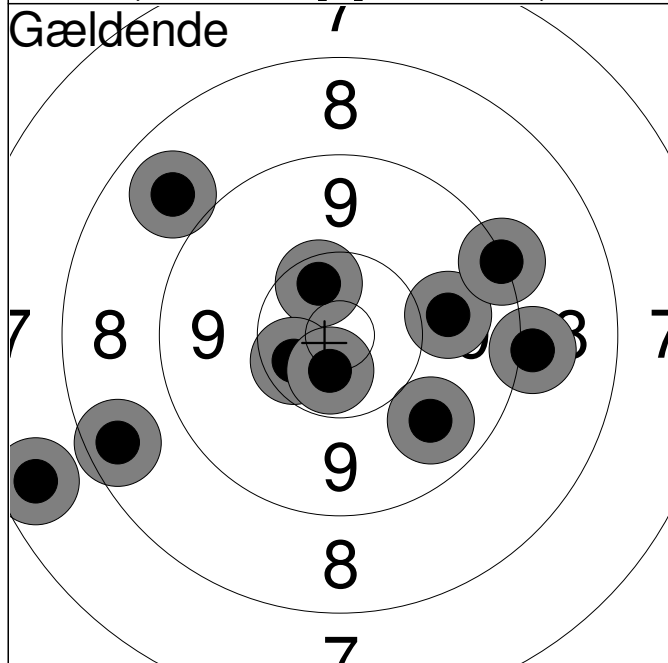

11:	9.7	↘
12:	8.8	↗
13:	*10.4	↗
14:	9.9	→
15:	*10.4	↖
16:	9.0	→
17:	7.6	↖
18:	*10.6	↘
19:	8.5	↖
20:	9.2	→
Serie		89.0
Total		187.0

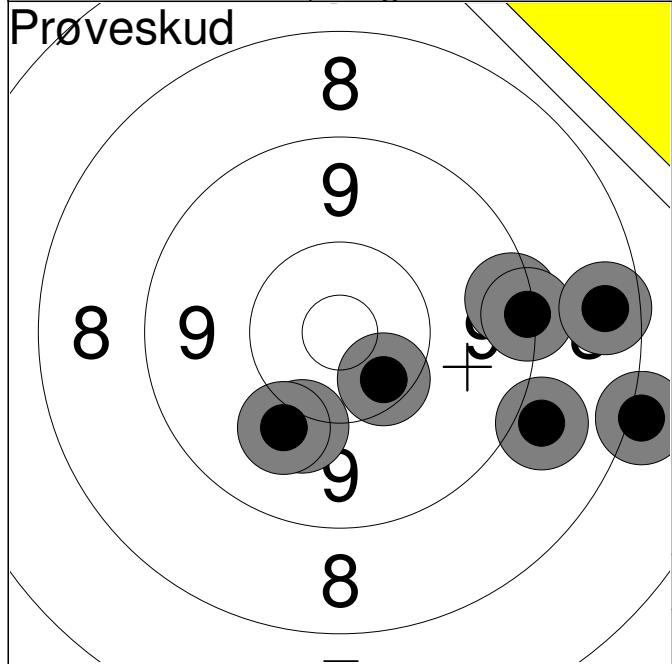

1:	8.9	→
2:	8.1	→
3:	9.4	→
4:	10.1	↙
5:	9.2	→
6:	10.0	↙
7:	10.4	↙
8:	8.5	→
Serie		72.0
Total		0.0

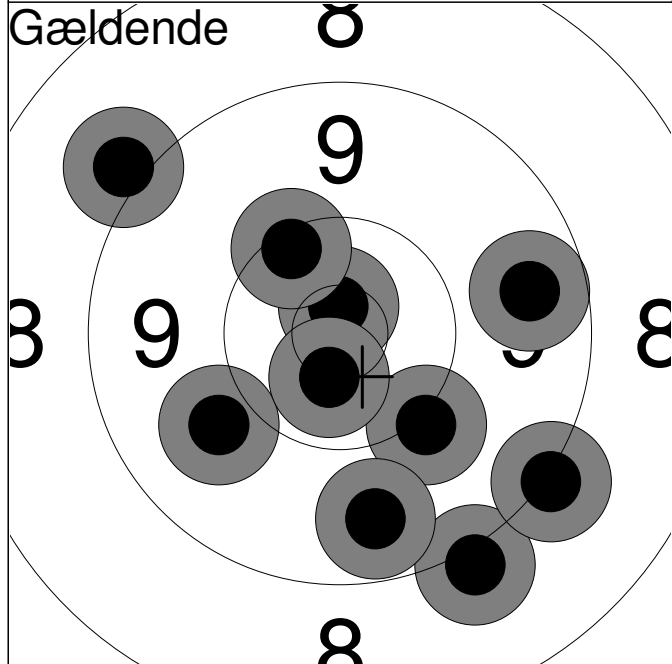

1:	10.1	↙
2:	9.6	→
3:	9.1	↙
4:	9.1	↙
5:	9.0	↗
6:	*10.8	↑
7:	9.9	↙
8:	*10.6	↙
9:	9.6	↙
10:	10.3	↗
Serie		94.0
Total		94.0

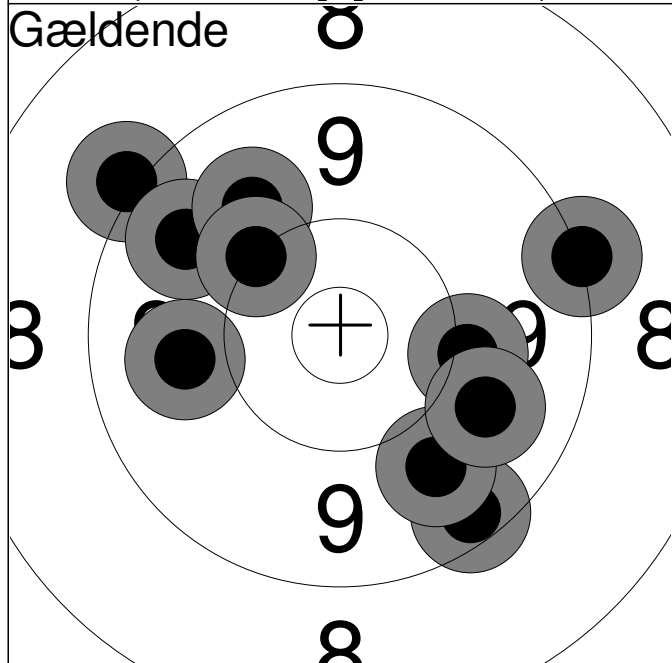

11:	9.4	↙
12:	9.1	↗
13:	10.1	→
14:	9.2	→
15:	9.8	↙
16:	9.7	↗
17:	9.8	↙
18:	9.9	←
19:	9.9	↗
20:	10.2	↗
Serie		92.0
Total		186.0

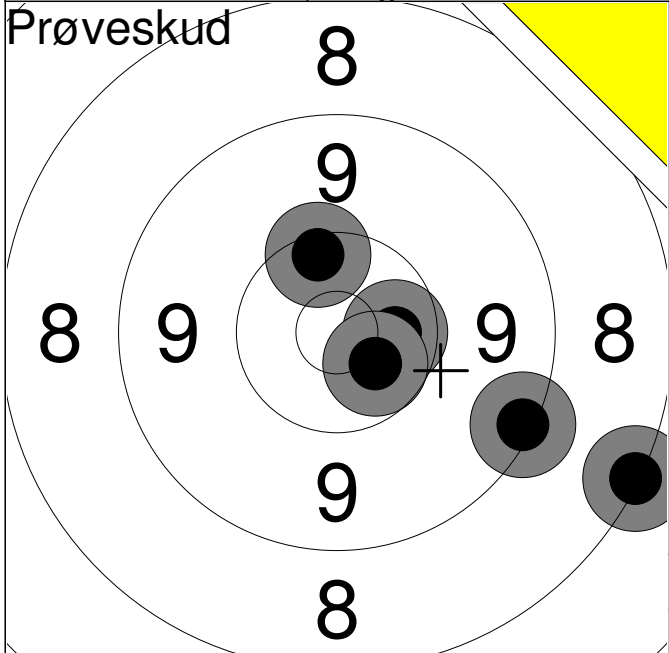
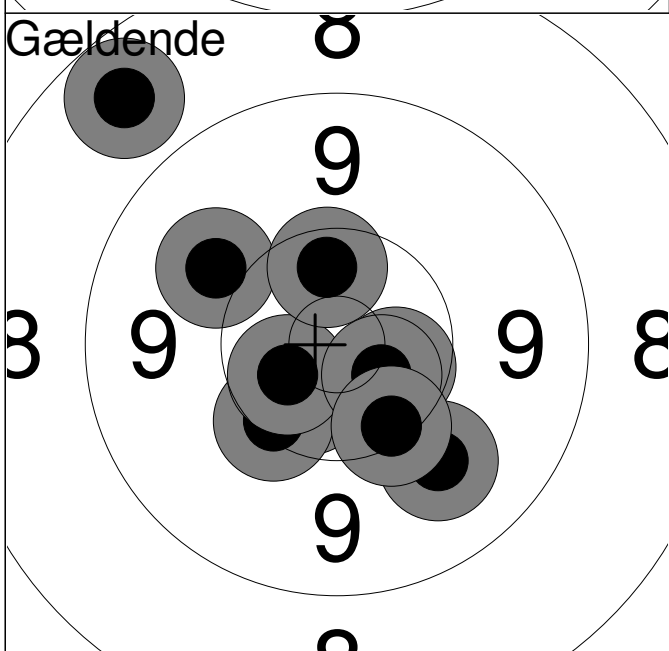
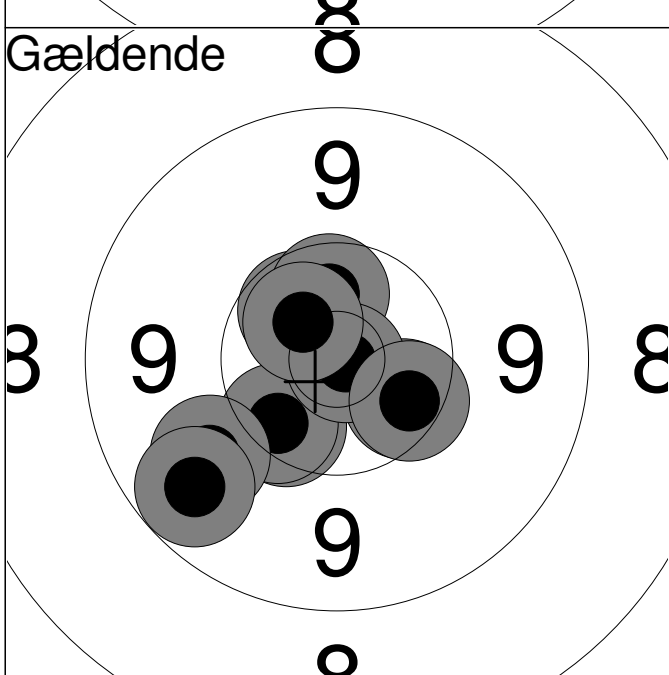
	Nordjysk Mesterskab 2013	Aalborg Skyttekreds																													
Prøveskud 	<table style="width:100%; border-collapse: collapse;"> <tr><td style="width:10%;">1:</td><td style="width:15%;">8.2</td><td style="width:10%; text-align: right;">↘</td></tr> <tr><td>2:</td><td>*10.5</td><td style="text-align: right;">→</td></tr> <tr><td>3:</td><td>*10.6</td><td style="text-align: right;">↘</td></tr> <tr><td>4:</td><td>9.3</td><td style="text-align: right;">↘</td></tr> <tr><td>5:</td><td>10.3</td><td style="text-align: right;">↑</td></tr> </table>	1:	8.2	↘	2:	*10.5	→	3:	*10.6	↘	4:	9.3	↘	5:	10.3	↑															
1:	8.2	↘																													
2:	*10.5	→																													
3:	*10.6	↘																													
4:	9.3	↘																													
5:	10.3	↑																													
	Serie	47.0																													
	Total	0.0																													
Gældende 	<table style="width:100%; border-collapse: collapse;"> <tr><td style="width:10%;">1:</td><td style="width:15%;">*10.6</td><td style="width:10%; text-align: right;">↘</td></tr> <tr><td>2:</td><td>10.0</td><td style="text-align: right;">↗</td></tr> <tr><td>3:</td><td>10.3</td><td style="text-align: right;">↘</td></tr> <tr><td>4:</td><td>8.6</td><td style="text-align: right;">↗</td></tr> <tr><td>5:</td><td>*10.6</td><td style="text-align: right;">↘</td></tr> <tr><td>6:</td><td>*10.5</td><td style="text-align: right;">↘</td></tr> <tr><td>7:</td><td>*10.4</td><td style="text-align: right;">↑</td></tr> <tr><td>8:</td><td>9.9</td><td style="text-align: right;">↘</td></tr> <tr><td>9:</td><td>*10.6</td><td style="text-align: right;">↘</td></tr> <tr><td>10:</td><td>10.3</td><td style="text-align: right;">↘</td></tr> </table>	1:	*10.6	↘	2:	10.0	↗	3:	10.3	↘	4:	8.6	↗	5:	*10.6	↘	6:	*10.5	↘	7:	*10.4	↑	8:	9.9	↘	9:	*10.6	↘	10:	10.3	↘
1:	*10.6	↘																													
2:	10.0	↗																													
3:	10.3	↘																													
4:	8.6	↗																													
5:	*10.6	↘																													
6:	*10.5	↘																													
7:	*10.4	↑																													
8:	9.9	↘																													
9:	*10.6	↘																													
10:	10.3	↘																													
	Serie	97.0																													
	Total	97.0																													
Gældende 	<table style="width:100%; border-collapse: collapse;"> <tr><td style="width:10%;">11:</td><td style="width:15%;">10.4</td><td style="width:10%; text-align: right;">↘</td></tr> <tr><td>12:</td><td>*10.5</td><td style="text-align: right;">↗</td></tr> <tr><td>13:</td><td>10.4</td><td style="text-align: right;">↘</td></tr> <tr><td>14:</td><td>*10.5</td><td style="text-align: right;">↑</td></tr> <tr><td>15:</td><td>*10.4</td><td style="text-align: right;">↘</td></tr> <tr><td>16:</td><td>*10.9</td><td style="text-align: right;">↘</td></tr> <tr><td>17:</td><td>10.4</td><td style="text-align: right;">↘</td></tr> <tr><td>18:</td><td>9.9</td><td style="text-align: right;">↘</td></tr> <tr><td>19:</td><td>9.6</td><td style="text-align: right;">↘</td></tr> <tr><td>20:</td><td>*10.6</td><td style="text-align: right;">↗</td></tr> </table>	11:	10.4	↘	12:	*10.5	↗	13:	10.4	↘	14:	*10.5	↑	15:	*10.4	↘	16:	*10.9	↘	17:	10.4	↘	18:	9.9	↘	19:	9.6	↘	20:	*10.6	↗
11:	10.4	↘																													
12:	*10.5	↗																													
13:	10.4	↘																													
14:	*10.5	↑																													
15:	*10.4	↘																													
16:	*10.9	↘																													
17:	10.4	↘																													
18:	9.9	↘																													
19:	9.6	↘																													
20:	*10.6	↗																													
	Serie	98.0																													
	Total	195.0																													

Hold	Skive	Trine Herskind		
54	1	Vodskov Skytteforening	BK1	
50m		Nordjysk Mesterskab 2013	Aalborg Skyttekreds	
Prøveskud		1:	9.7	↙
		2:	*10.6	↗
		3:	9.8	↙
		4:	*10.8	↘
		5:	*10.5	↗
		6:	*10.5	→
		7:	10.2	↘
		Serie	68.0	
Total	0.0			
Gældende		1:	10.3	↙
		2:	10.3	↘
		3:	*10.5	↙
		4:	*10.6	↘
		5:	10.3	→
		6:	10.0	→
		7:	10.3	↑
		8:	*10.5	↗
		9:	*10.6	↙
		10:	*10.8	↑
Serie	100.0			
Total	100.0			
Gældende		11:	10.1	↙
		12:	*10.8	↙
		13:	*10.5	↑
		14:	10.4	↙
		15:	10.3	↙
		16:	9.4	↙
		17:	*10.4	↗
		18:	9.8	↙
		19:	9.2	↙
		20:	10.2	↗
Serie	97.0			
Total	197.0			

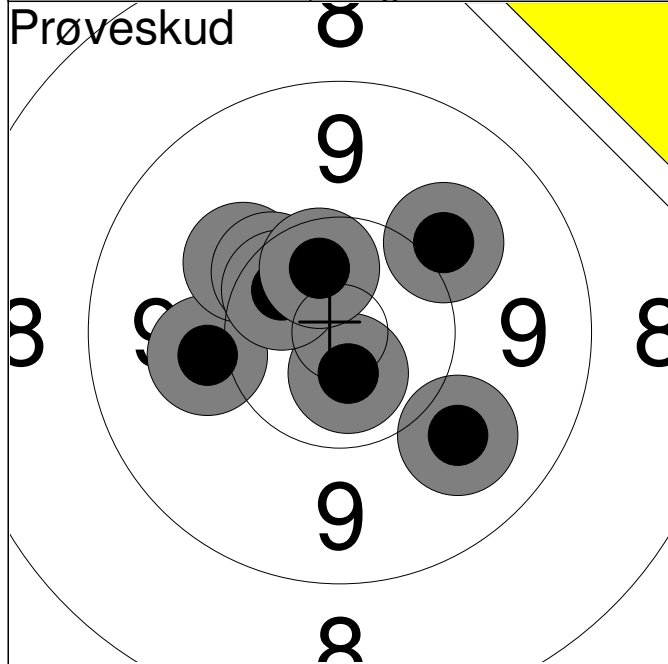

1:	9.9	↘
2:	*10.7	↘
3:	10.0	↗
4:	10.0	←
5:	10.1	↗
6:	10.3	↗
7:	*10.5	↗
8:	*10.5	↗
Serie		79.0
Total		0.0

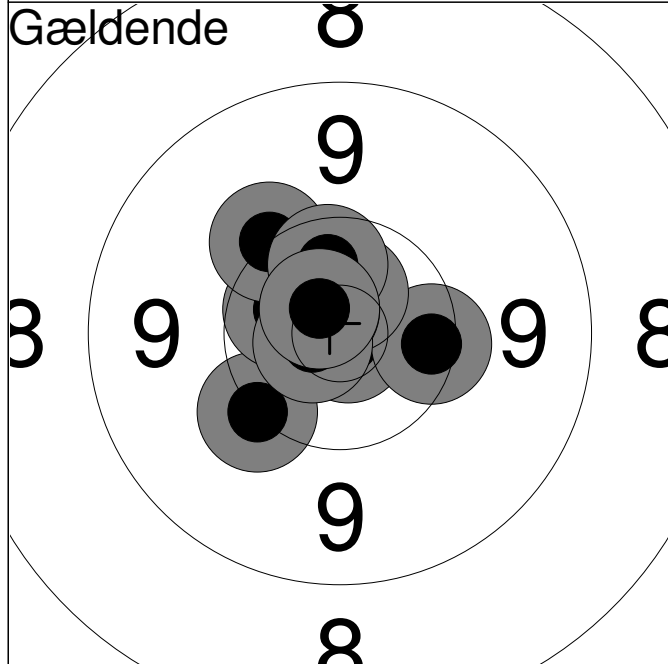

1:	10.2	↙
2:	*10.9	↘
3:	10.3	→
4:	*10.7	↑
5:	*10.5	↗
6:	10.2	↗
7:	*10.5	↑
8:	*10.7	↗
9:	*10.8	↙
10:	*10.7	↗
Serie		100.0
Total		100.0

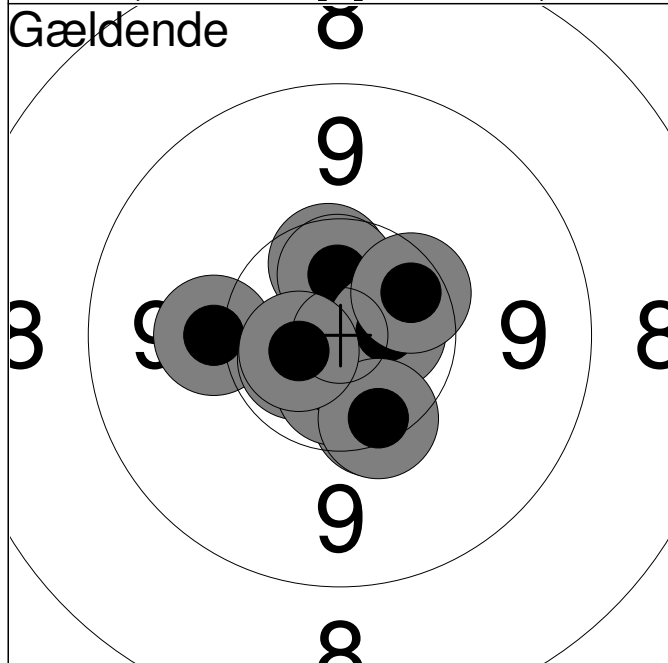

11:	10.1	←
12:	*10.6	↙
13:	10.3	↘
14:	*10.5	↑
15:	*10.5	↑
16:	*10.6	↘
17:	*10.6	→
18:	10.4	↗
19:	10.3	↘
20:	*10.7	↙
Serie		100.0
Total		200.0

Hold 54	Skive 3	Frederik B. Sørensen	
-------------------	-------------------	-----------------------------	--

50m	Løgstør Sportsskytteklub	J2	
-----	--------------------------	----	--

	Nordjysk Mesterskab 2013	Aalborg Skyttekreds	
--	--------------------------	---------------------	--

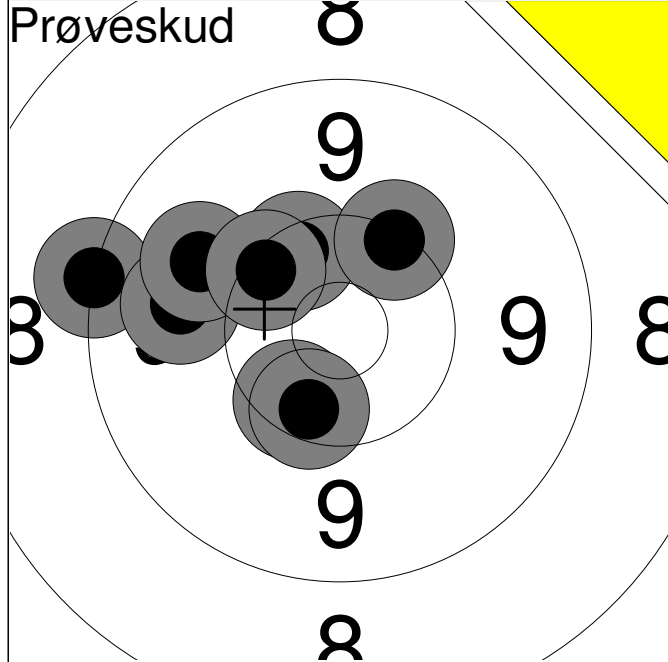

1:	10.4	↙
2:	10.4	↙
3:	9.2	←
4:	10.3	↗
5:	9.8	←
6:	9.9	↗
7:	10.2	↗
8:	10.3	↗
Serie		77.0
Total		0.0

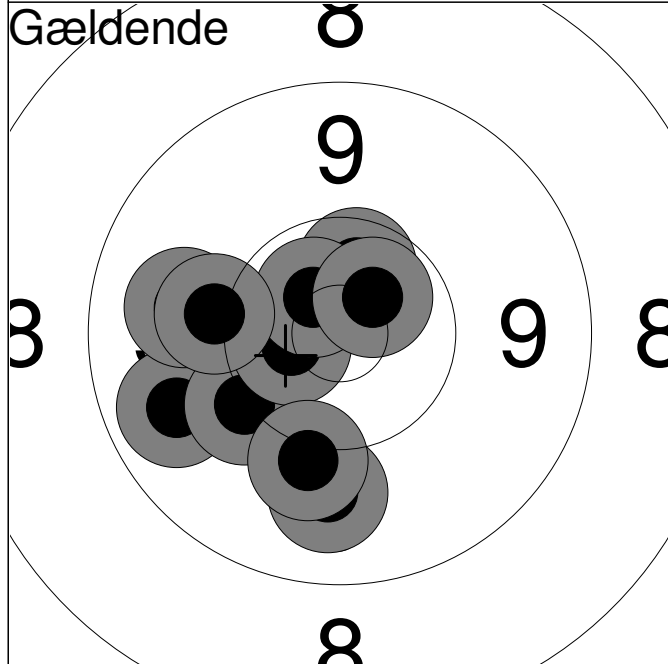

1:	9.9	↓
2:	9.7	←
3:	10.1	↙
4:	*10.6	←
5:	*10.5	↑
6:	*10.6	↗
7:	9.9	←
8:	10.1	←
9:	*10.6	↗
10:	10.1	↓
Serie		97.0
Total		97.0

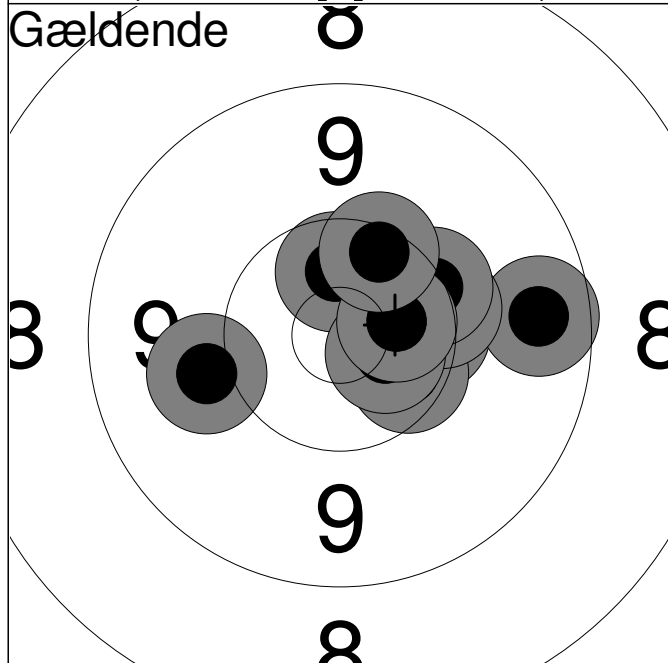

11:	10.3	→
12:	*10.5	↑
13:	*10.4	↘
14:	9.6	→
15:	10.2	→
16:	10.2	↗
17:	*10.6	↘
18:	10.0	←
19:	*10.6	→
20:	10.3	↗
Serie		99.0
Total		196.0

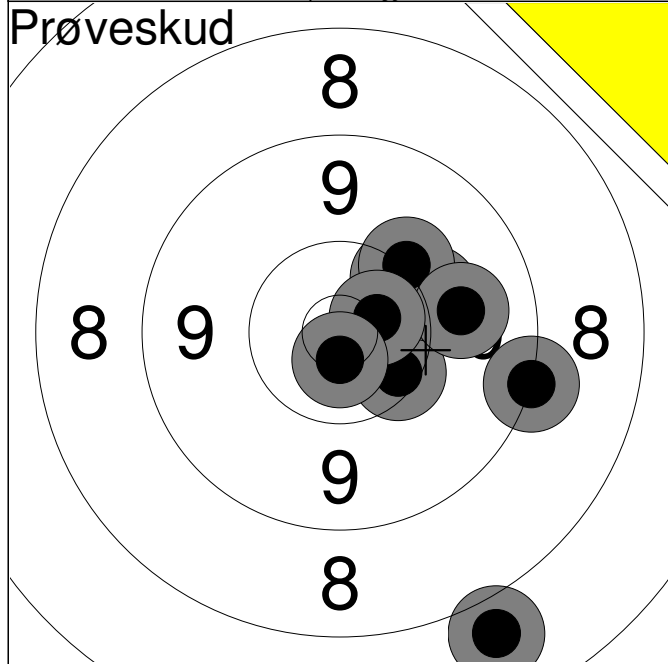

1:	7.8	↓
2:	10.3	↓
3:	9.2	→
4:	10.1	→
5:	10.3	↗
6:	10.1	↗
7:	9.9	→
8:	*10.6	→
9:	*10.7	↓

Serie	85.0
Total	0.0

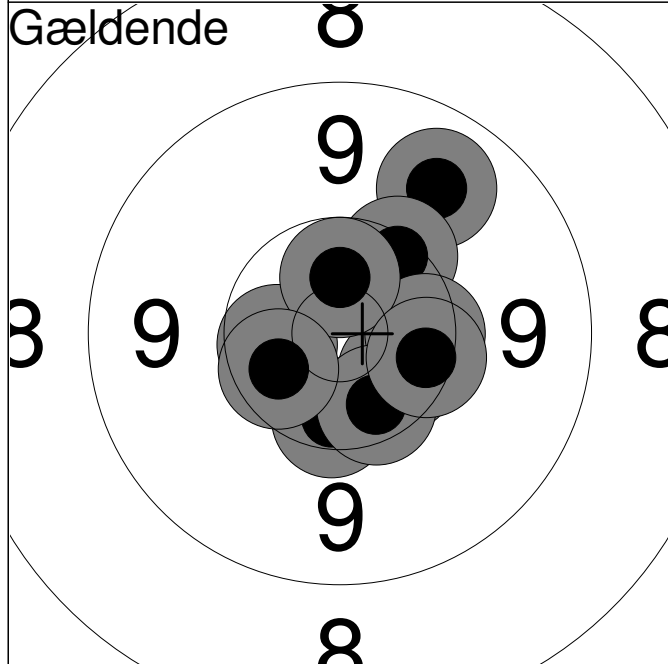

1:	9.7	↗
2:	10.3	↗
3:	10.4	↓
4:	*10.5	↓
5:	10.4	→
6:	*10.5	←
7:	*10.6	↑
8:	10.4	↓
9:	10.3	→
10:	*10.5	↙

Serie	99.0
Total	99.0

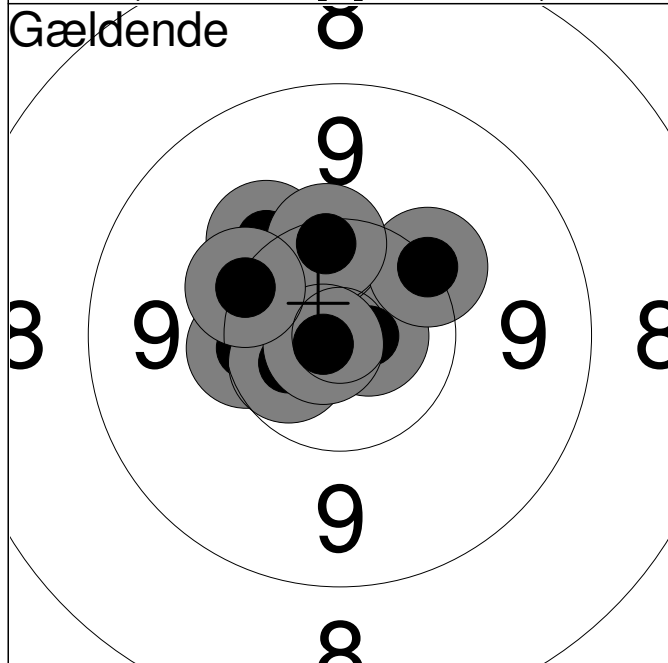

11:	*10.6	↖
12:	10.3	←
13:	10.1	↗
14:	*10.5	↙
15:	*10.8	→
16:	10.4	↑
17:	10.2	↗
18:	10.3	↑
19:	*10.8	↙
20:	10.2	↖

Serie	100.0
Total	199.0

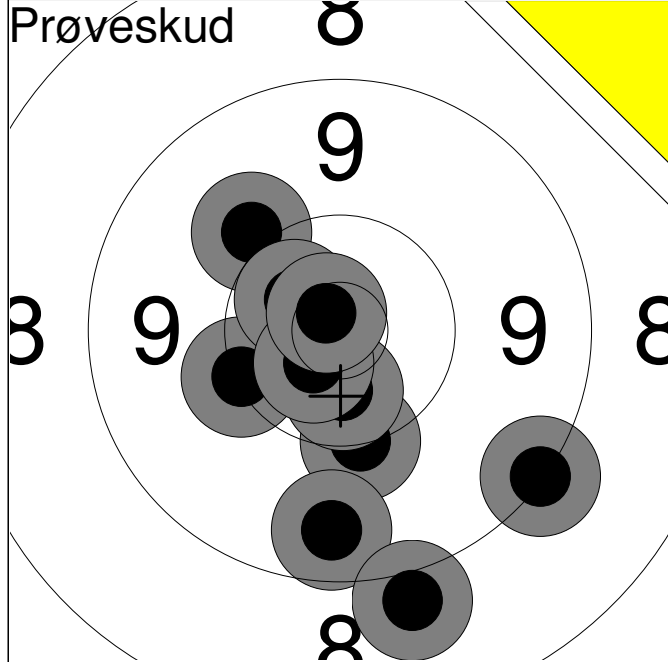

1:	10.0	↗
2:	9.2	↘
3:	10.2	↓
4:	10.2	↖
5:	*10.6	↗
6:	*10.5	↓
7:	9.6	↓
8:	*10.7	↖
9:	*10.8	↗
10:	9.0	↓
Serie		97.0
Total		0.0

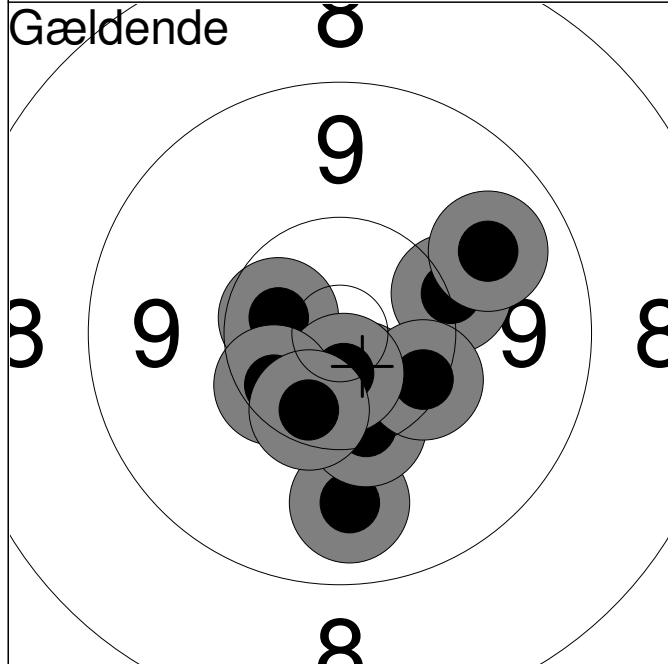

1:	*10.5	↖
2:	9.8	↓
3:	*10.6	↓
4:	10.1	↗
5:	10.3	↓
6:	10.3	↘
7:	*10.7	↓
8:	10.4	↖
9:	10.4	↓
10:	9.8	↗
Serie		98.0
Total		98.0

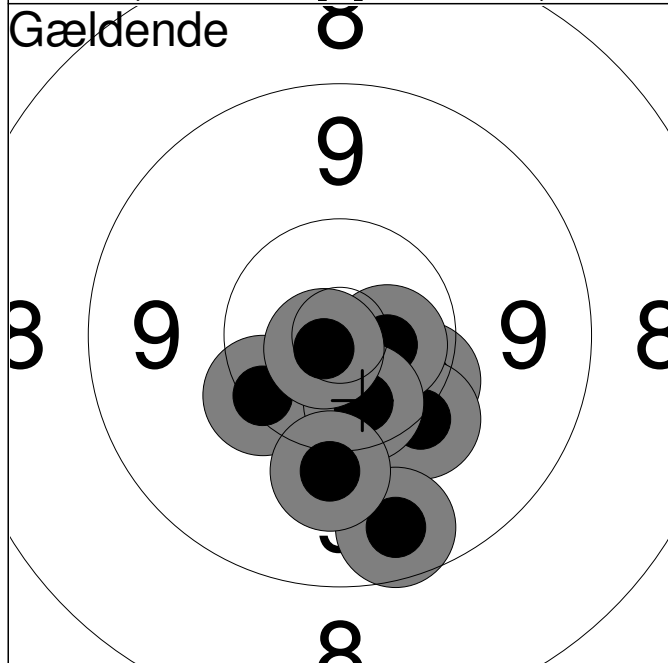

11:	*10.5	↓
12:	10.4	↓
13:	10.3	↘
14:	10.3	↖
15:	10.2	↘
16:	*10.6	↗
17:	9.6	↓
18:	*10.5	↓
19:	*10.8	↖
20:	10.0	↓
Serie		99.0
Total		197.0

Hold 54	Skive 7	Nikolai Bøjer	
-------------------	-------------------	----------------------	--

50m	Løgstør Sportsskytteklub	BK3
-----	--------------------------	-----

	Nordjysk Mesterskab 2013	Aalborg Skyttekreds
--	--------------------------	---------------------

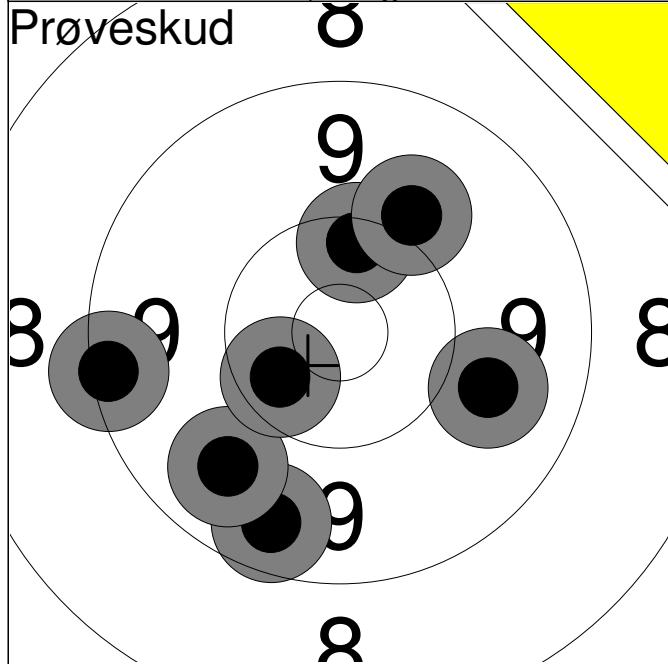

1:	9.5	↘
2:	9.7	↙
3:	9.9	→
4:	*10.4	↙
5:	9.3	←
6:	10.3	↑
7:	10.0	↗
Serie		66.0
Total		0.0

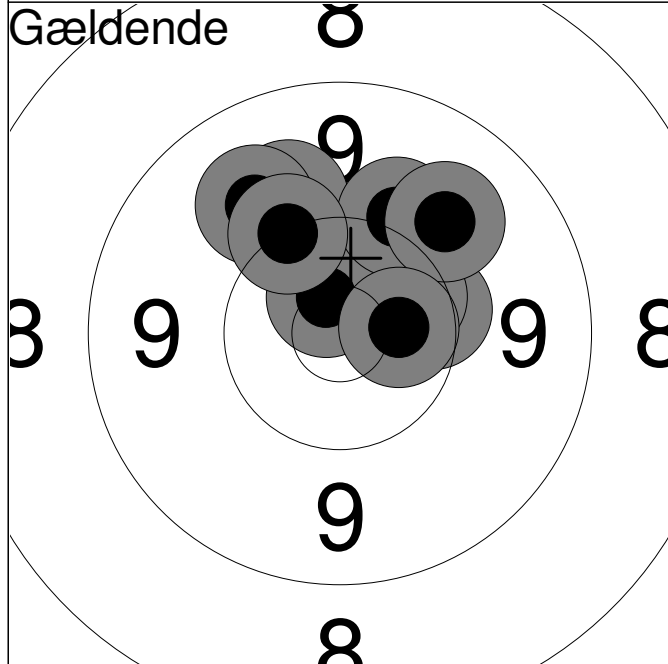

1:	10.4	↑
2:	10.3	→
3:	10.0	↑
4:	*10.4	↗
5:	9.9	↑
6:	*10.7	↑
7:	10.1	↗
8:	9.9	↗
9:	10.2	↑
10:	*10.5	→
Serie		98.0
Total		98.0

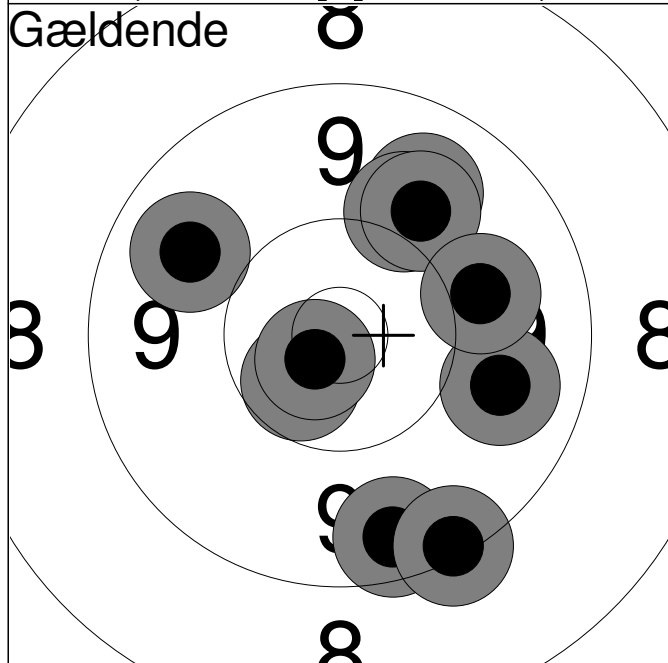

11:	*10.5	↙
12:	9.8	↗
13:	10.0	↗
14:	9.9	↗
15:	9.5	↘
16:	9.3	↘
17:	9.8	→
18:	*10.7	↙
19:	9.9	→
20:	9.8	↙
Serie		93.0
Total		191.0

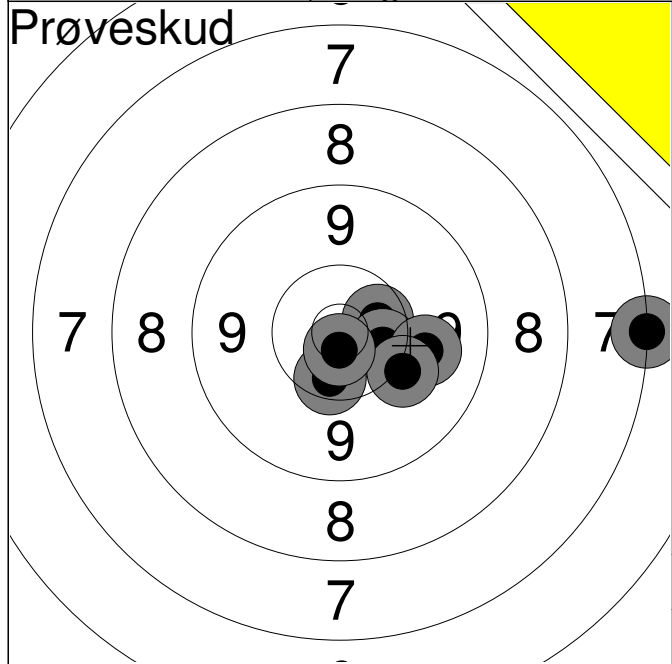

1:	7.2	→
2:	*10.5	→
3:	*10.4	→
4:	9.9	→
5:	10.1	↘
6:	10.4	↓
7:	*10.7	↓
Serie		66.0
Total		0.0

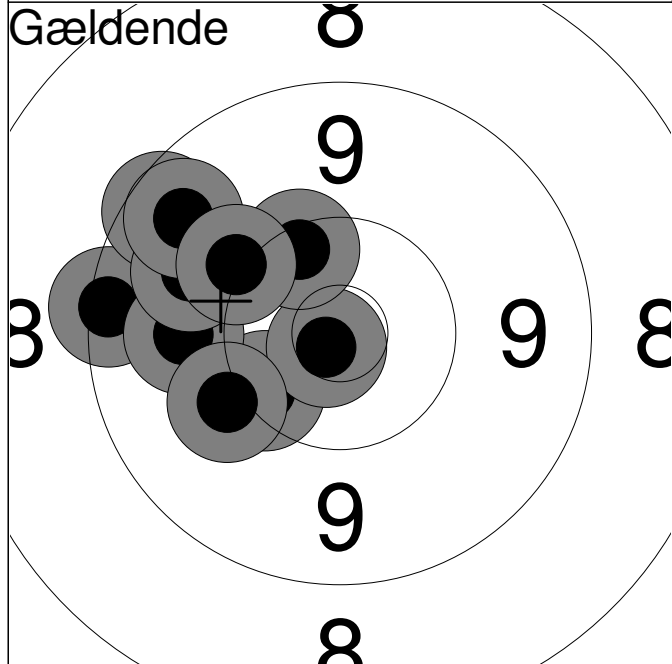

1:	9.3	←
2:	10.3	↙
3:	*10.8	↙
4:	9.9	←
5:	9.4	↗
6:	10.0	↙
7:	9.8	↗
8:	10.3	↗
9:	9.6	↗
10:	10.1	↗
Serie		95.0
Total		95.0

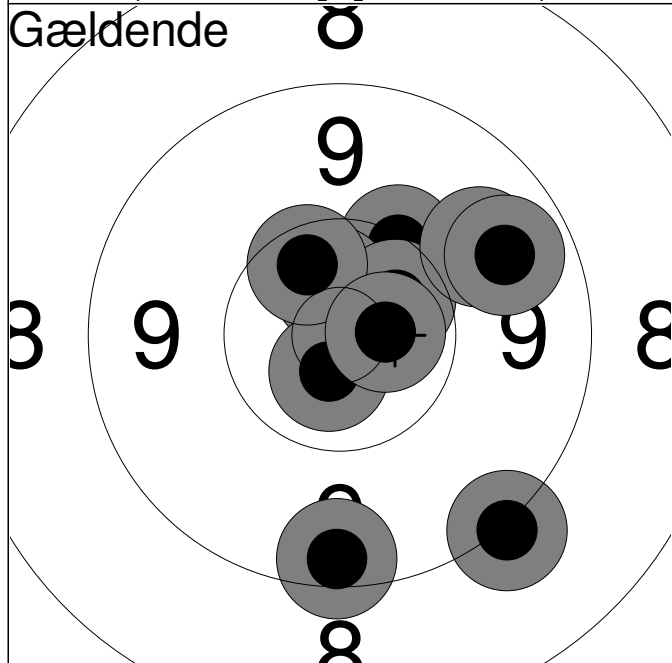

11:	10.2	↗
12:	9.4	↓
13:	*10.6	↑
14:	*10.5	↗
15:	9.8	↗
16:	*10.7	↓
17:	*10.4	↑
18:	*10.6	→
19:	9.1	↓
20:	9.7	↗
Serie		96.0
Total		191.0

Hold	Skive	Nicklas Bundgaard	
54	10		

50m	Vadum Skf.	BK1	
-----	------------	-----	--

	Nordjysk Mesterskab 2013	Aalborg Skyttekreds	
--	--------------------------	---------------------	--

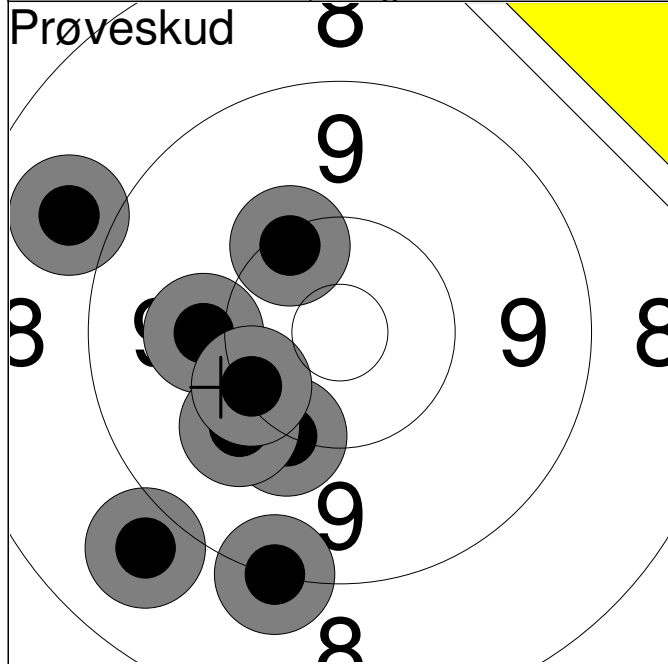

1:	9.2	↓
2:	8.9	↙
3:	10.0	←
4:	10.2	↘
5:	10.3	↗
6:	10.0	↙
7:	8.9	↗
8:	10.2	↙
Serie		75.0
Total		0.0

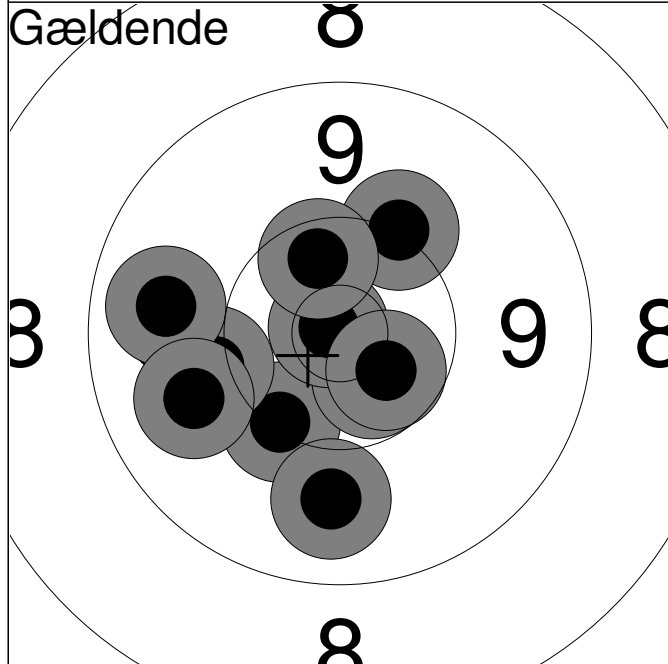

1:	10.2	↘
2:	*10.6	↘
3:	*10.9	↗
4:	10.1	←
5:	10.1	↗
6:	*10.5	↘
7:	9.7	←
8:	9.8	↓
9:	9.9	↙
10:	*10.4	↗
Serie		97.0
Total		97.0

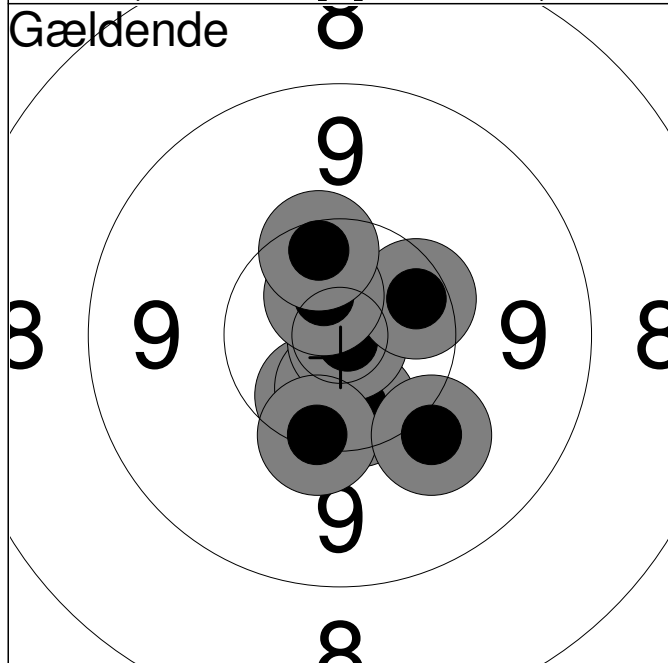

11:	10.4	↓
12:	*10.5	↘
13:	*10.6	↓
14:	*10.4	↘
15:	*10.9	↘
16:	10.4	↗
17:	*10.7	↗
18:	10.2	↘
19:	10.4	↗
20:	10.0	↘
Serie		100.0
Total		197.0

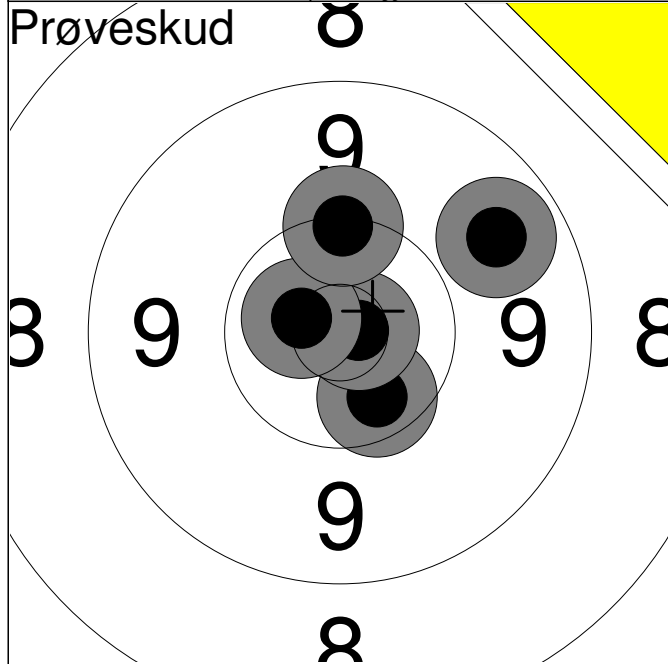

1:	*10.4	↘
2:	*10.8	→
3:	*10.7	↙
4:	9.7	↗
5:	10.2	↑
Serie		49.0
Total		0.0

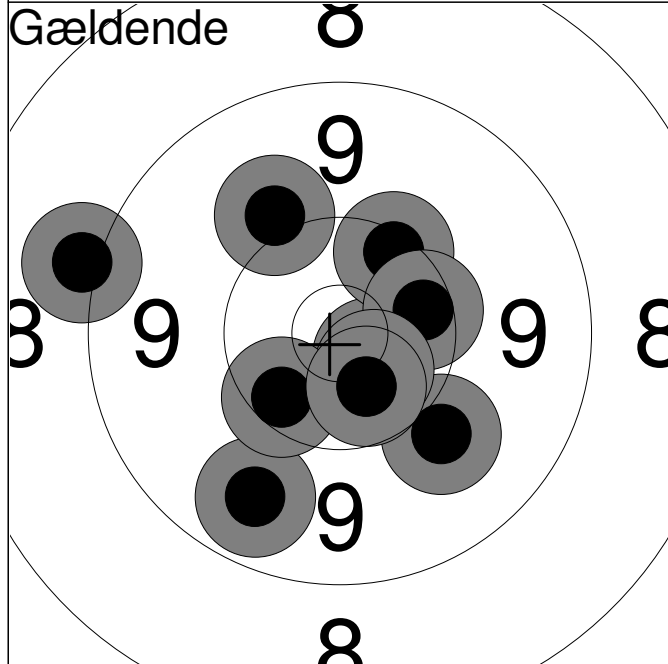

1:	*10.7	↘
2:	10.3	↗
3:	10.4	→
4:	9.1	↙
5:	9.7	↘
6:	10.0	↗
7:	10.0	↘
8:	*10.6	↘
9:	10.4	↙
10:	*10.5	↘
Serie		98.0
Total		98.0

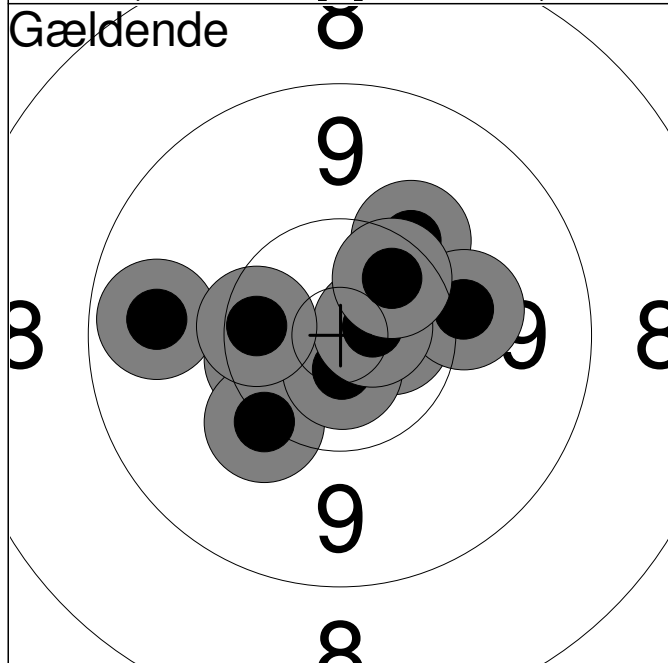

11:	9.7	↙
12:	*10.6	→
13:	10.1	↗
14:	10.4	↙
15:	10.2	↘
16:	10.1	→
17:	*10.7	↘
18:	*10.7	→
19:	10.4	↙
20:	*10.4	↗
Serie		99.0
Total		197.0

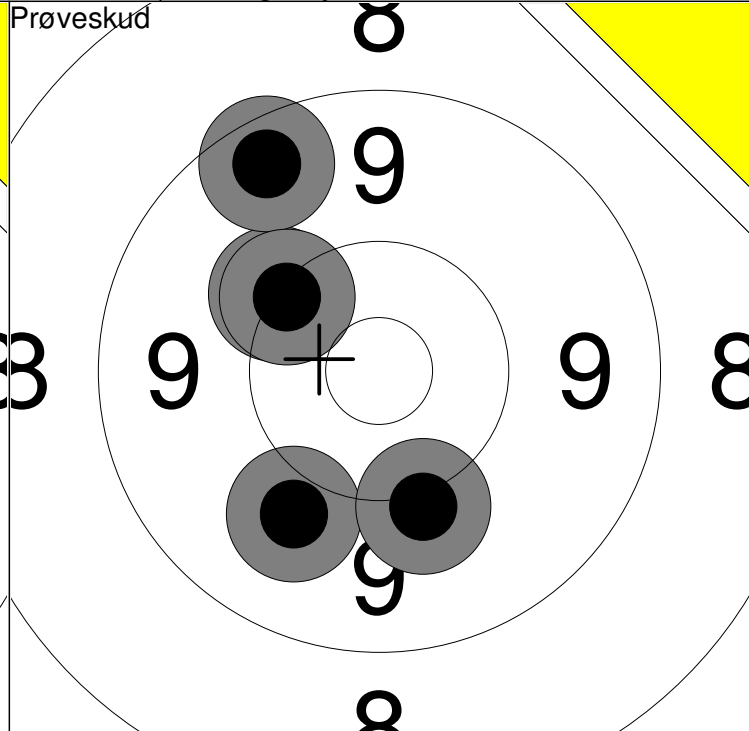
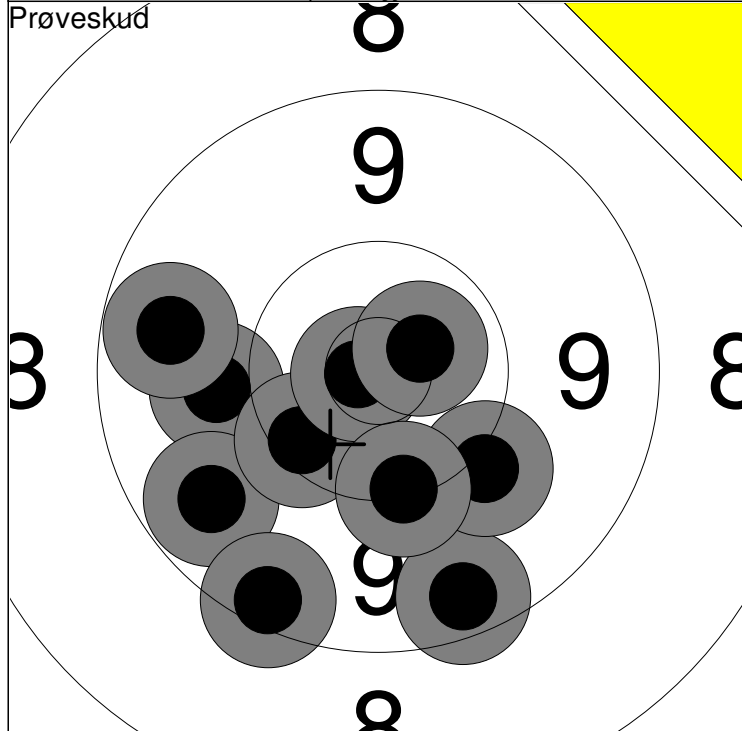

1: 10.0 ←	6: *10.8 ←	Serie	96
2: 9.4 ↓	7: 10.1 ↘		
3: 9.6 ↙	8: 10.2 ↓	Total	0
4: 9.4 ↓	9: *10.7 ↗		
5: 10.3 ↙	10: 9.6 ←		

11: 9.9 ↘	Serie	48
12: 10.1 ↓		
13: 10.2 ↗	Total	0
14: 9.5 ↗		
15: 10.2 ↗		

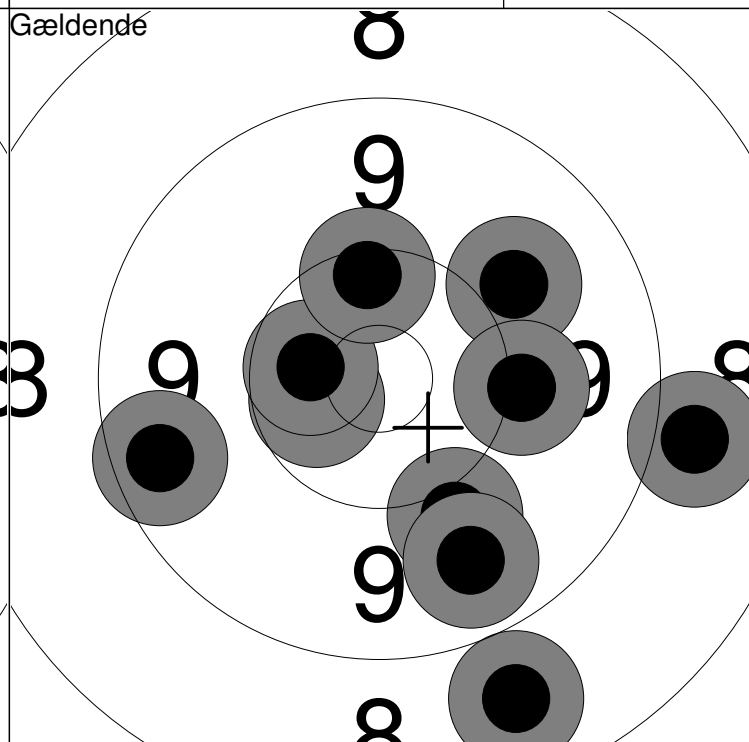
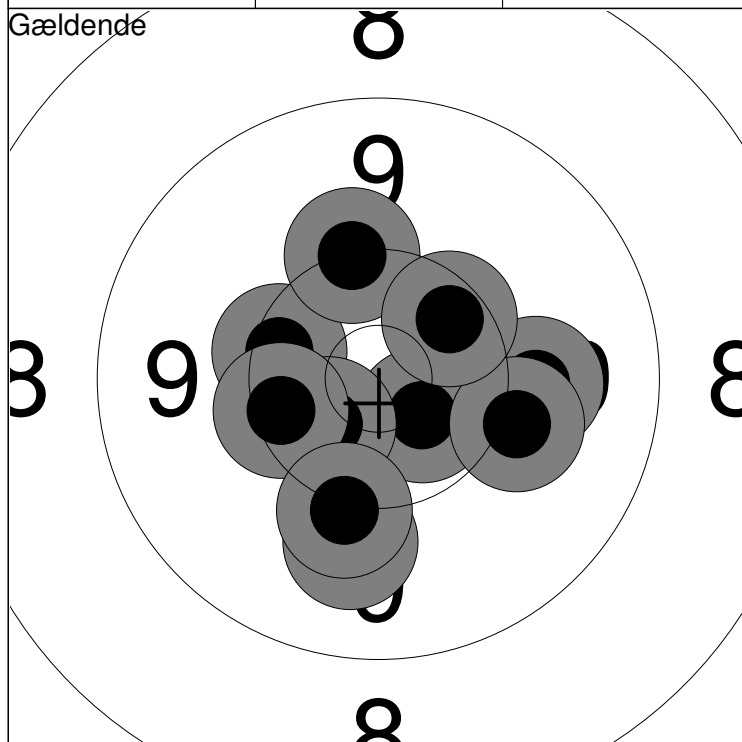

1: 10.3 ←	6: 10.2 ↑	Serie	99
2: *10.6 ↘	7: 10.0 →		
3: 9.9 ↓	8: 10.1 ↓	Total	99
4: *10.5 ↙	9: 10.1 →		
5: 10.3 ←	10: 10.4 ↗		

11: 8.9 →	16: *10.5 ←	Serie	93
12: 9.9 ↗	17: 9.5 ←		
13: 10.0 ↓	18: 10.1 →	Total	192
14: *10.5 ←	19: 9.7 ↓		
15: 8.7 ↓	20: 10.3 ↑		

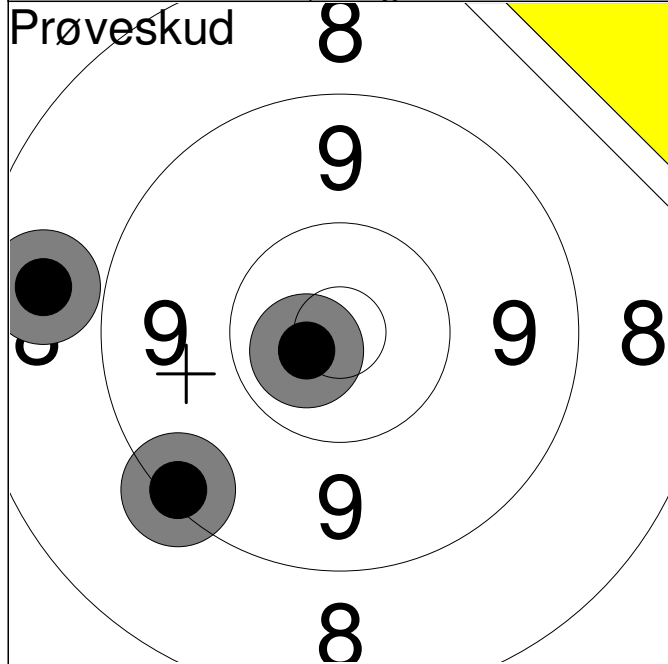

1:	8.7	←
2:	9.3	↙
3:	*10.7	↙
Serie		27.0
Total		0.0

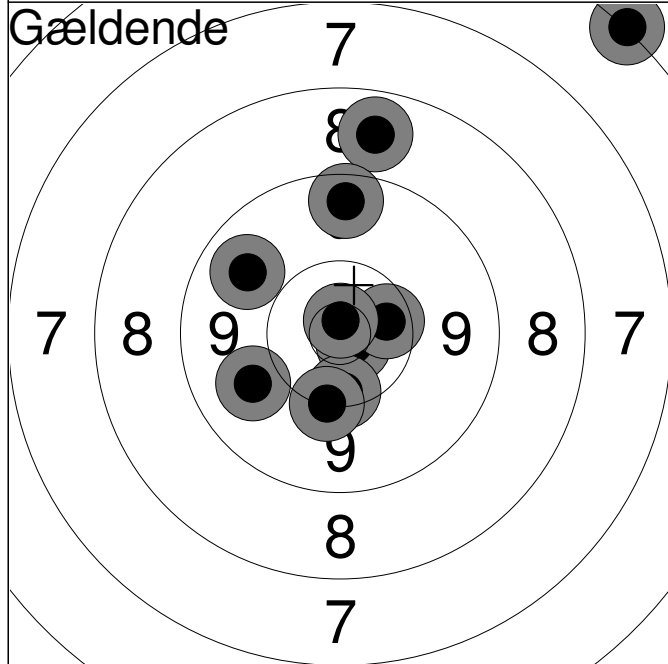

1:	9.9	↙
2:	*10.8	↘
3:	8.7	↑
4:	*10.4	→
5:	10.3	↓
6:	10.2	↓
7:	6.1	↗
8:	*10.8	↑
9:	9.5	↑
10:	9.7	↘
Serie		91.0
Total		91.0

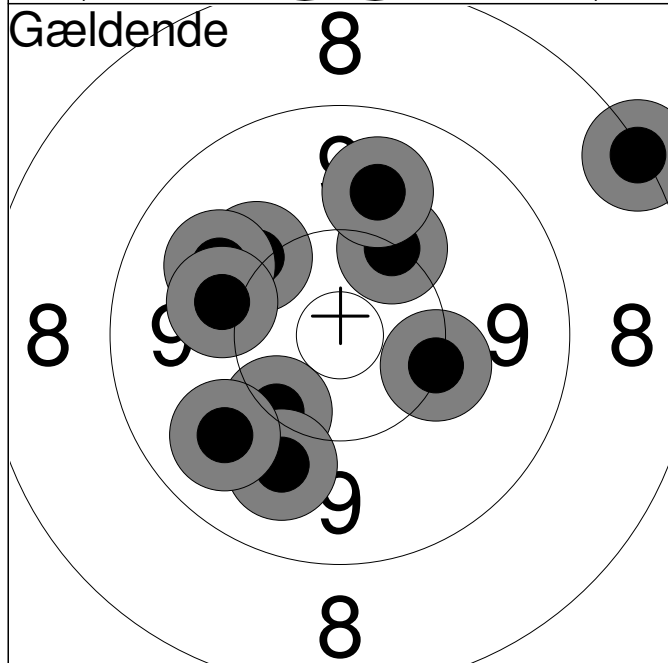

11:	10.2	→
12:	10.2	↗
13:	10.2	↙
14:	9.8	↑
15:	10.1	↖
16:	9.9	↖
17:	10.0	←
18:	9.9	↙
19:	9.8	↙
20:	8.2	↗
Serie		94.0
Total		185.0

Hold	Skive	Magnus Larsen	
55	3		

50m	Vodskov Skytteforening	BK1	
-----	------------------------	-----	--

	Nordjysk Mesterskab 2013	Aalborg Skyttekreds	
--	--------------------------	---------------------	--

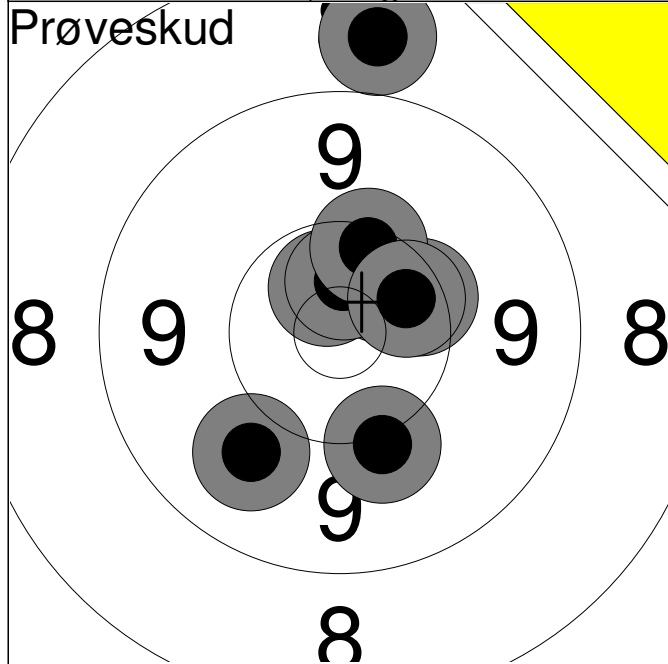

1:	8.7	↑
2:	9.9	↙
3:	10.1	↘
4:	*10.5	↗
5:	*10.6	↑
6:	10.3	→
7:	*10.6	↑
8:	10.3	↑
9:	*10.4	↗
Serie		87.0
Total		0.0

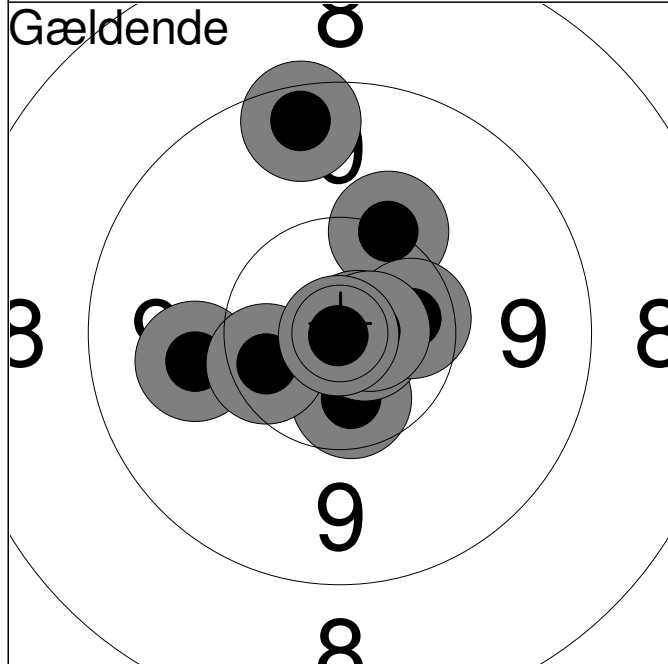

1:	*10.5	↘
2:	9.9	←
3:	10.2	↗
4:	*10.8	→
5:	*10.8	→
6:	*10.5	→
7:	10.4	←
8:	*10.7	→
9:	9.4	↑
10:	*10.9	↙
Serie		98.0
Total		98.0

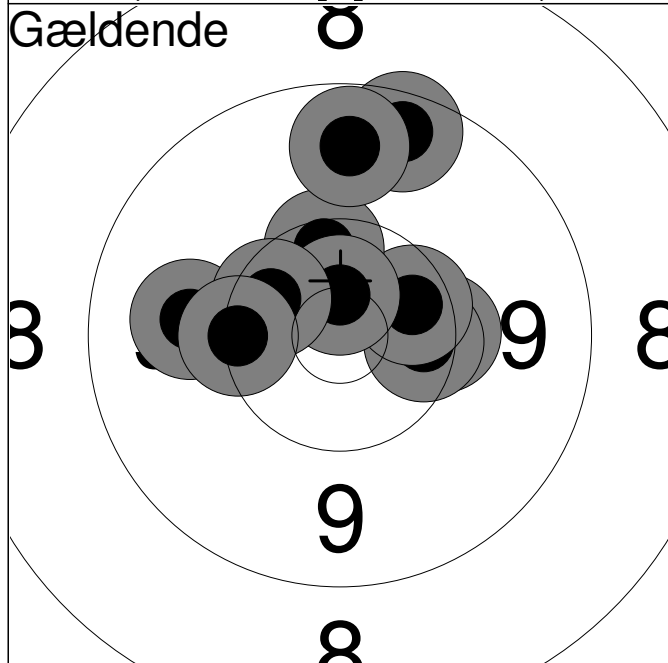

11:	10.3	→
12:	10.4	→
13:	10.4	↗
14:	9.5	↑
15:	10.4	↑
16:	9.6	↑
17:	*10.7	↑
18:	9.9	←
19:	*10.4	↙
20:	10.3	←
Serie		97.0
Total		195.0

Hold 55	Skive 4	Magnus Andersen
-------------------	-------------------	------------------------

50m	Vodskov Skytteforening	BK1
-----	------------------------	-----

	Nordjysk Mesterskab 2013	Aalborg Skyttekreds
--	--------------------------	---------------------

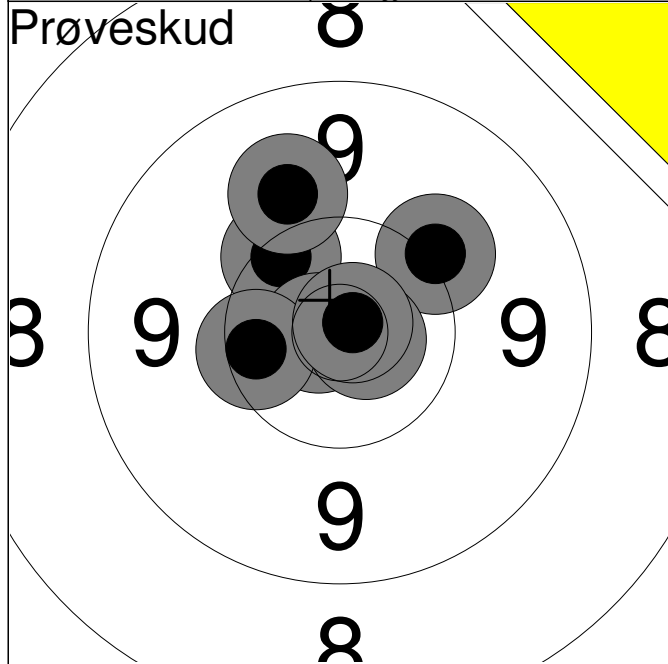

1:	10.3	↗
2:	*10.8	←
3:	10.1	↗
4:	*10.8	→
5:	9.9	↑
6:	10.4	←
7:	*10.8	↗
Serie		69.0
Total		0.0

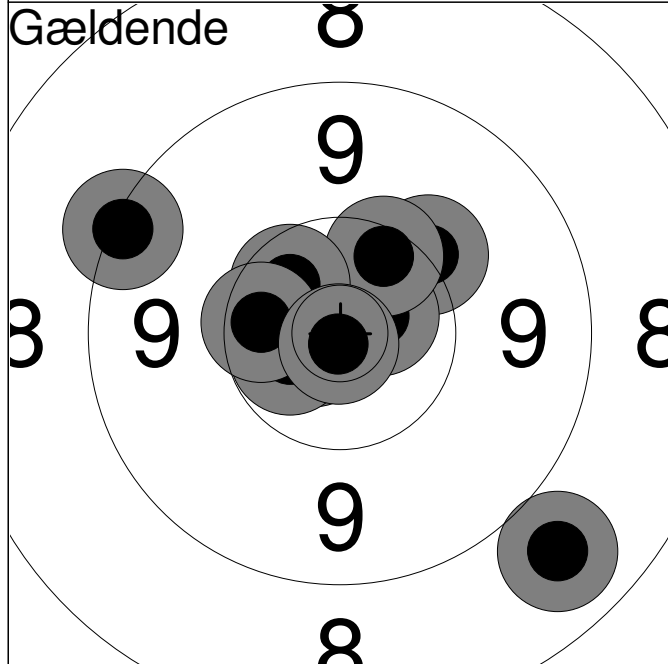

1:	*10.7	↖
2:	9.3	↖
3:	*10.6	↖
4:	10.1	↗
5:	8.8	↘
6:	*10.7	↗
7:	10.3	↗
8:	*10.5	↗
9:	10.4	←
10:	*10.9	↓
Serie		97.0
Total		97.0

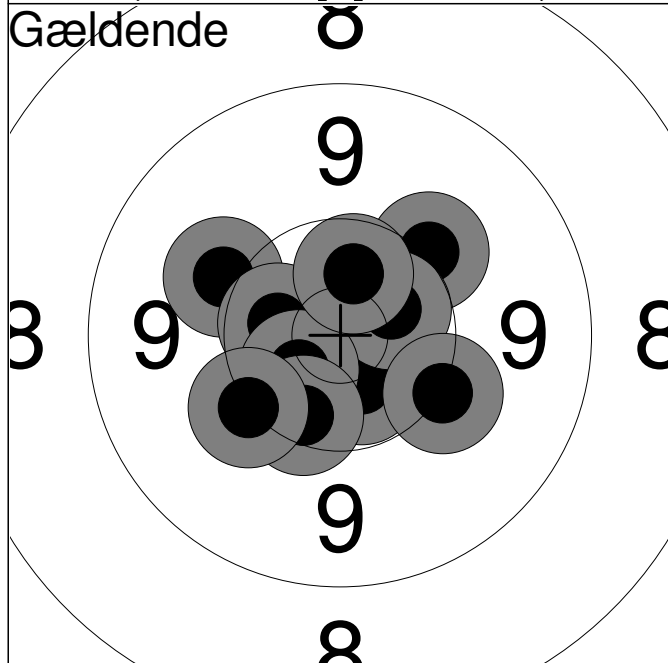

11:	10.1	↖
12:	*10.6	↓
13:	*10.5	←
14:	10.1	↗
15:	*10.6	↗
16:	*10.6	↖
17:	*10.5	↑
18:	10.3	↘
19:	10.2	↖
20:	10.1	↘
Serie		100.0
Total		197.0

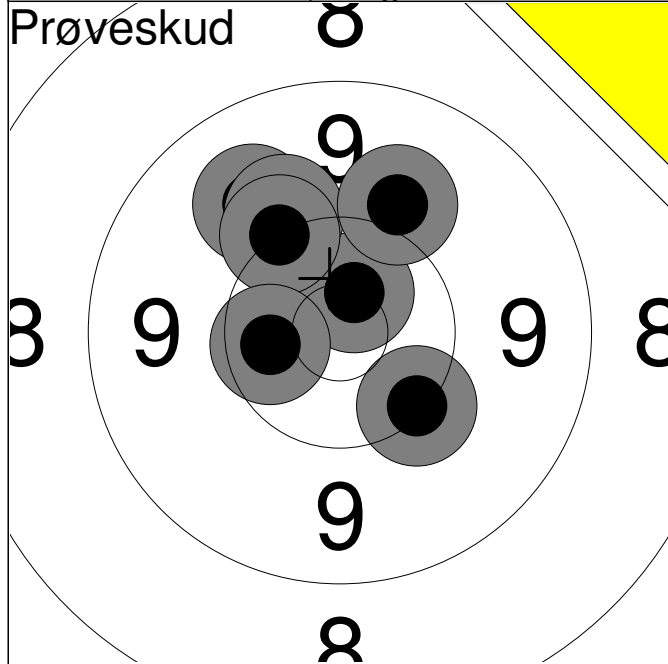

1:	*10.7	↗
2:	9.9	↗
3:	10.1	↗
4:	10.0	↗
5:	10.2	↘
6:	10.2	↗
7:	*10.5	↖
Serie		69.0
Total		0.0

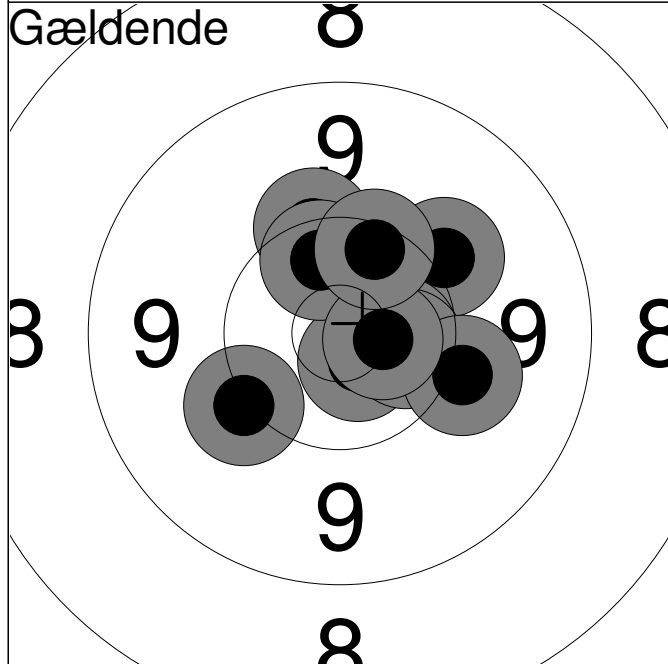

1:	10.2	↗
2:	10.1	↖
3:	10.1	↗
4:	*10.7	↘
5:	*10.6	→
6:	*10.5	→
7:	10.1	→
8:	*10.4	↗
9:	*10.7	→
10:	10.3	↗
Serie		100.0
Total		100.0

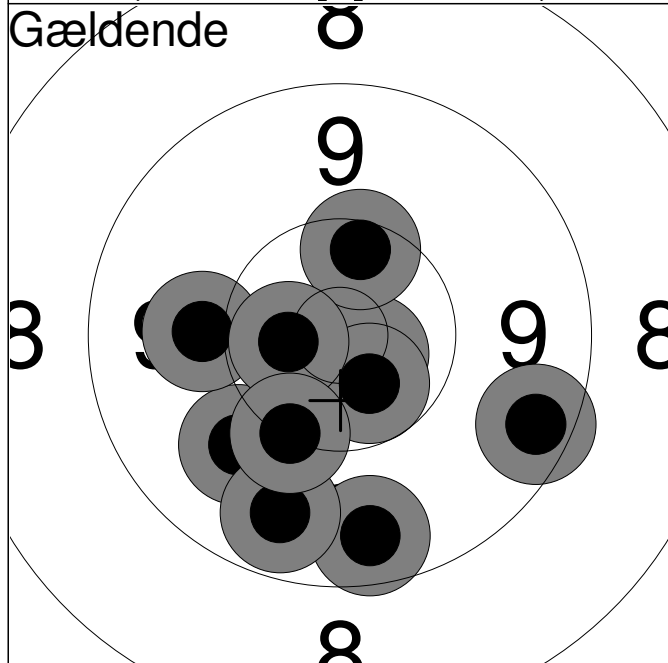

11:	9.9	↖
12:	9.4	→
13:	9.5	↘
14:	10.0	↖
15:	*10.7	↘
16:	*10.6	↘
17:	10.3	↗
18:	9.6	↘
19:	*10.6	↖
20:	10.2	↘
Serie		96.0
Total		196.0

Hold	Skive	Tonny Nielsen	
55	6		

50m	Vodskov Skytteforening	ÅK2	
-----	------------------------	-----	--

	Nordjysk Mesterskab 2013	Aalborg Skyttekreds	
--	--------------------------	---------------------	--

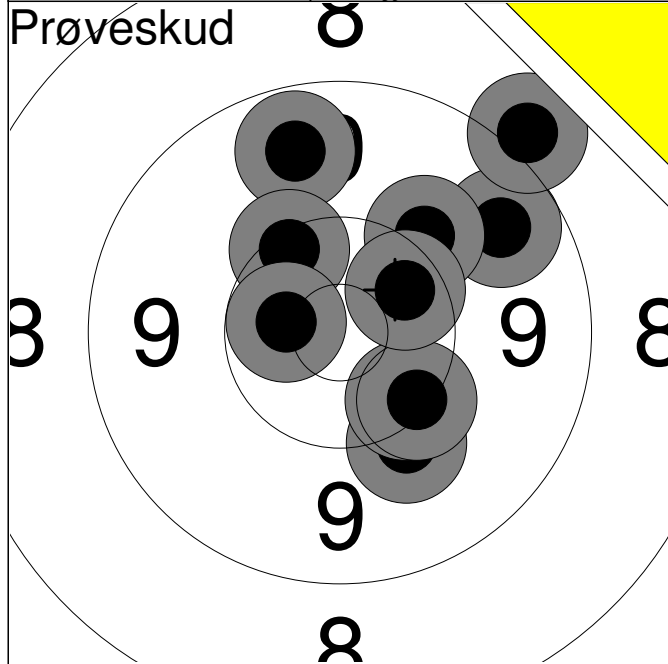

1:	9.6	↗
2:	10.1	↗
3:	9.0	↗
4:	9.6	↑
5:	10.1	↓
6:	10.3	↓
7:	10.2	↓
8:	10.3	↑
9:	*10.6	←
10:	*10.4	↗
Serie		97.0
Total		0.0

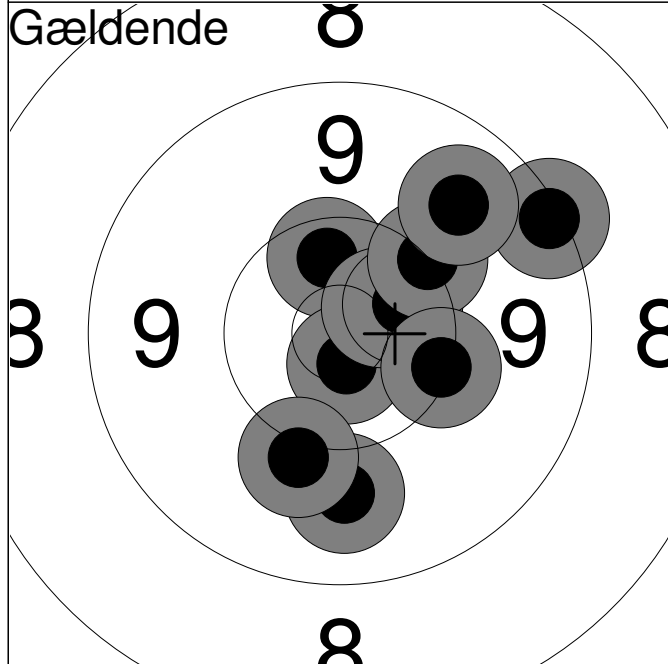

1:	*10.4	↑
2:	*10.7	↓
3:	*10.6	↗
4:	*10.5	↗
5:	9.9	↓
6:	9.3	↗
7:	10.2	↗
8:	10.1	↓
9:	10.2	→
10:	9.7	↗
Serie		97.0
Total		97.0

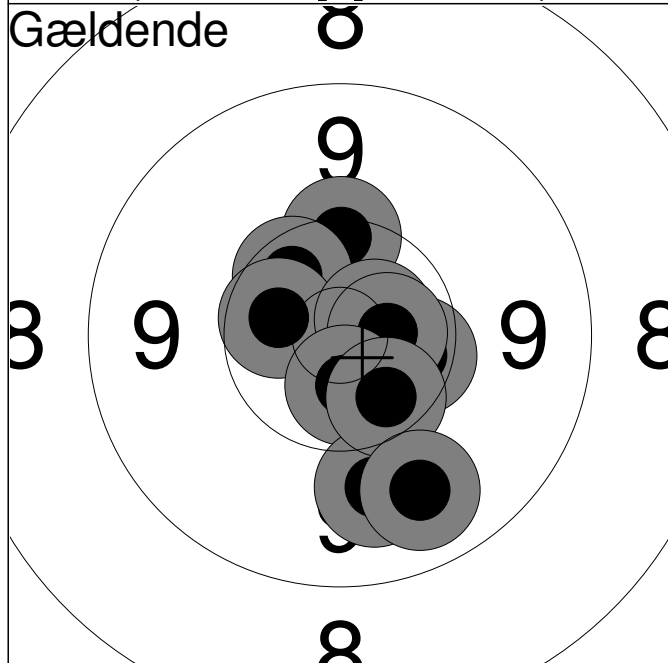

11:	10.3	↑
12:	10.4	→
13:	*10.4	↗
14:	*10.5	←
15:	*10.7	↗
16:	*10.6	→
17:	*10.6	↓
18:	9.9	↓
19:	*10.4	↓
20:	9.7	↓
Serie		98.0
Total		195.0

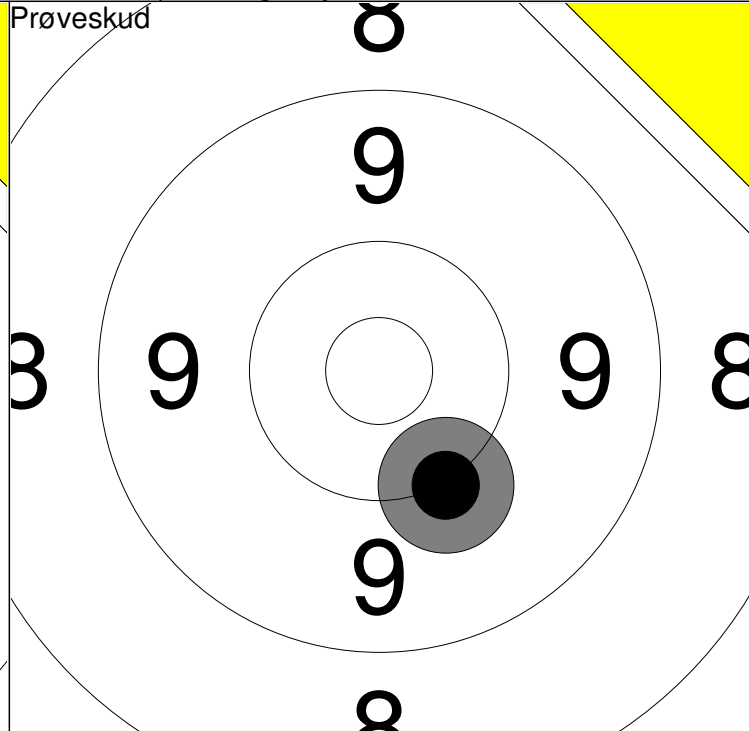
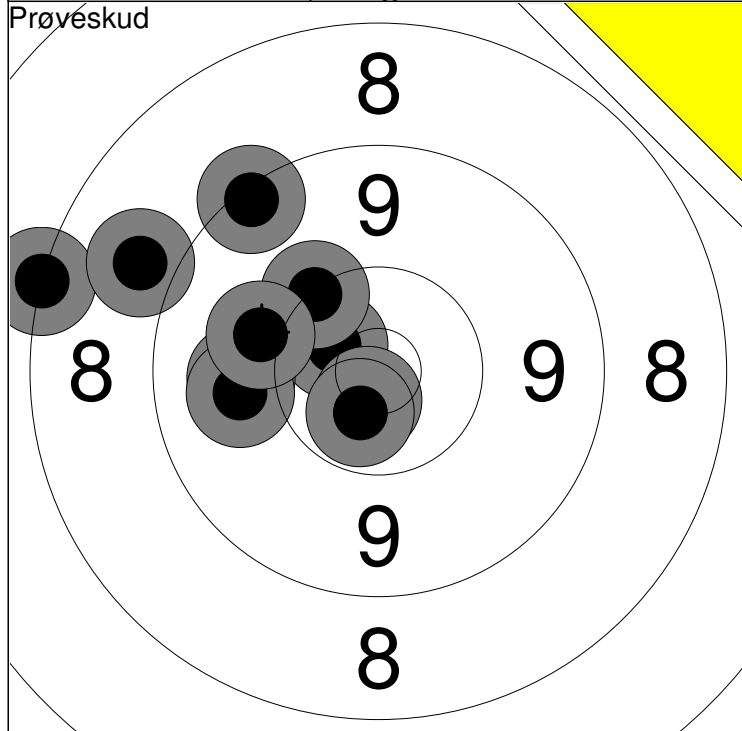

1: 9.3 ↗	6: *10.7 ↓	Serie	93
2: 8.2 ↖	7: 9.9 ←		
3: 8.9 ↗	8: 9.9 ←	Total	0
4: *10.6 ↖	9: *10.6 ↓		
5: 10.2 ↗	10: 10.0 ←		

11: 10.1 ↓	Serie	10
	Total	0

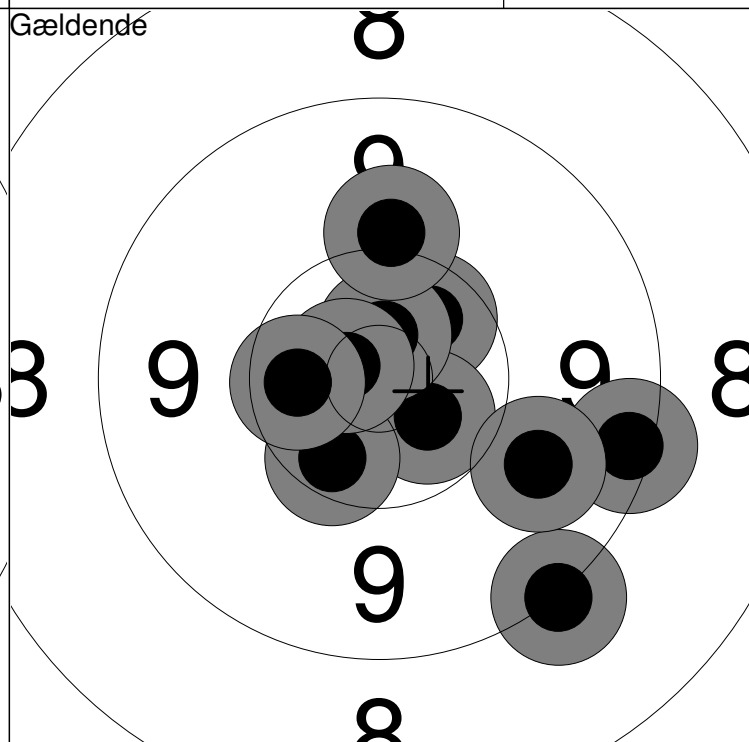
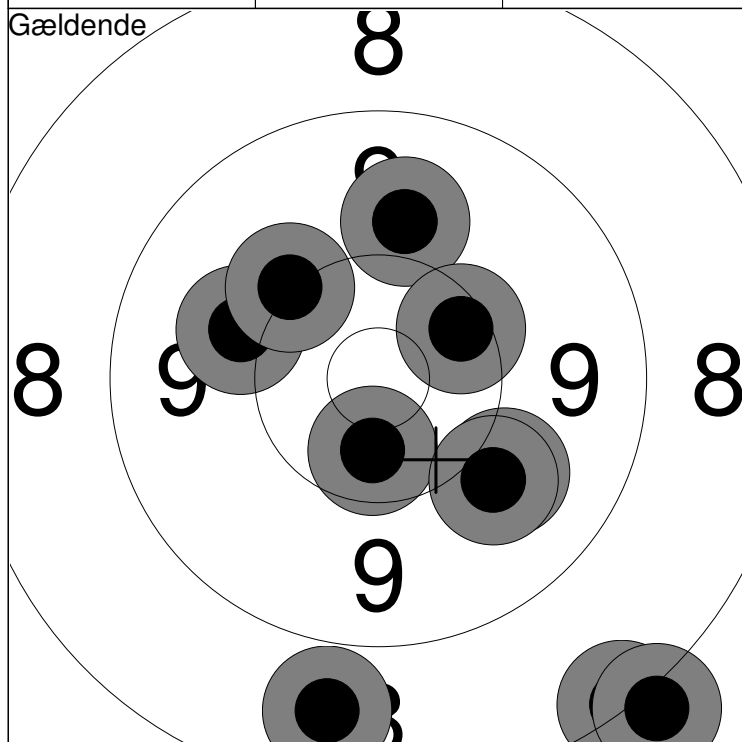

1: 10.0 ←	6: 10.0 ↘	Serie	92
2: 10.1 ↗	7: 8.0 ↘		
3: *10.5 ↓	8: 8.7 ↓	Total	92
4: 8.2 ↘	9: 9.9 ↑		
5: 9.9 ↘	10: 10.3 ↗		

11: 9.2 ↓	16: *10.7 ↑	Serie	97
12: *10.5 ↗	17: *10.7 ↖		
13: *10.6 ↘	18: 9.8 ↘	Total	189
14: 10.4 ↓	19: 10.1 ↑		
15: 9.3 →	20: *10.5 ←		

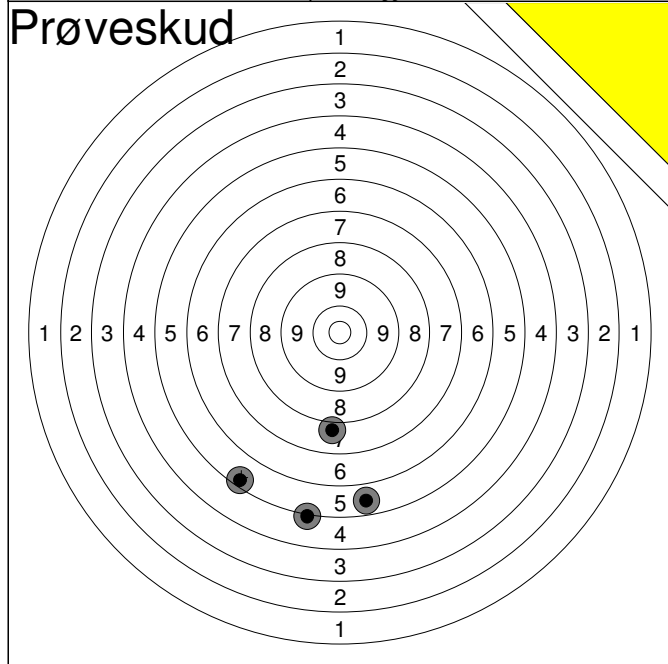

	1:	5.4	↙
	2:	0.0	←
	3:	5.1	↓
	4:	5.7	↓
	5:	7.9	↓
Serie			22.0
Total			0.0

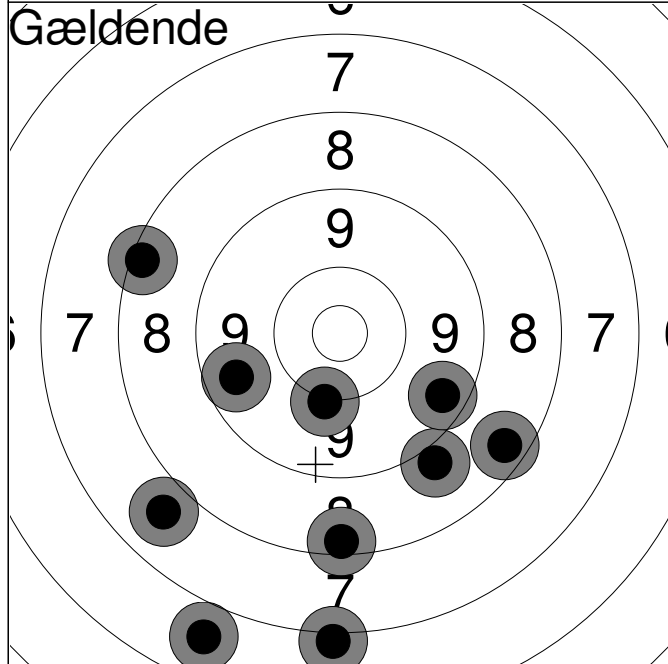

	1:	6.7	↙
	2:	9.0	↘
	3:	7.1	↓
	4:	10.1	↓
	5:	9.6	←
	6:	7.8	↙
	7:	8.5	↘
	8:	8.3	↓
	9:	8.3	↖
	10:	9.5	↘
Serie			81.0
Total			81.0

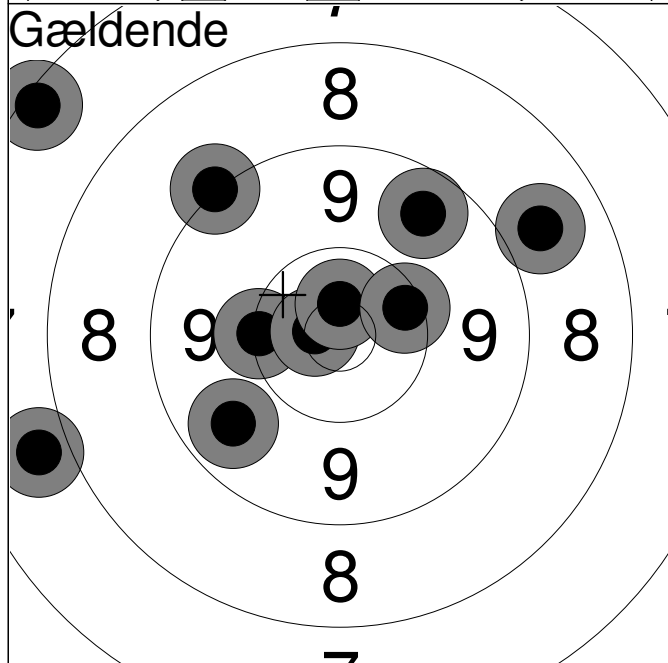

	11:	10.2	←
	12:	9.6	↗
	13:	9.7	↙
	14:	*10.7	←
	15:	7.3	↖
	16:	*10.7	↑
	17:	10.3	↗
	18:	7.9	↙
	19:	8.8	↗
	20:	9.2	↖
Serie			89.0
Total			170.0

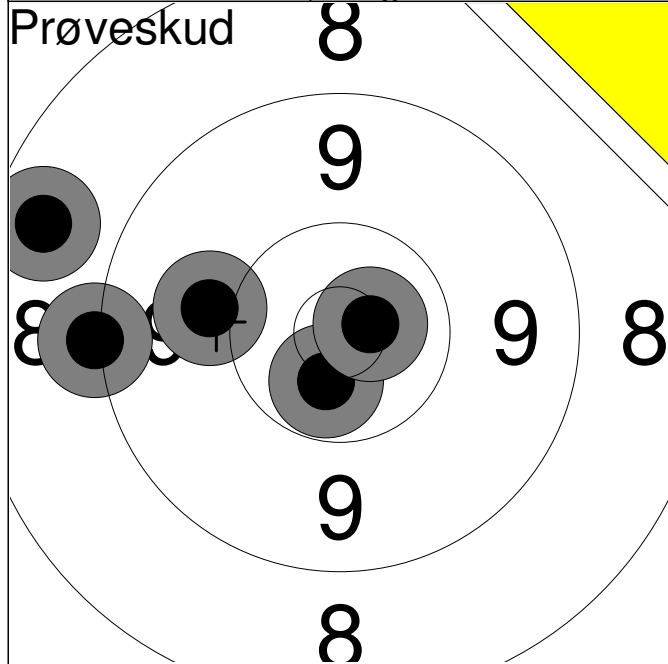

1:	8.6	←
2:	10.0	←
3:	9.1	←
4:	*10.6	↓
5:	*10.7	→
Serie		47.0
Total		0.0

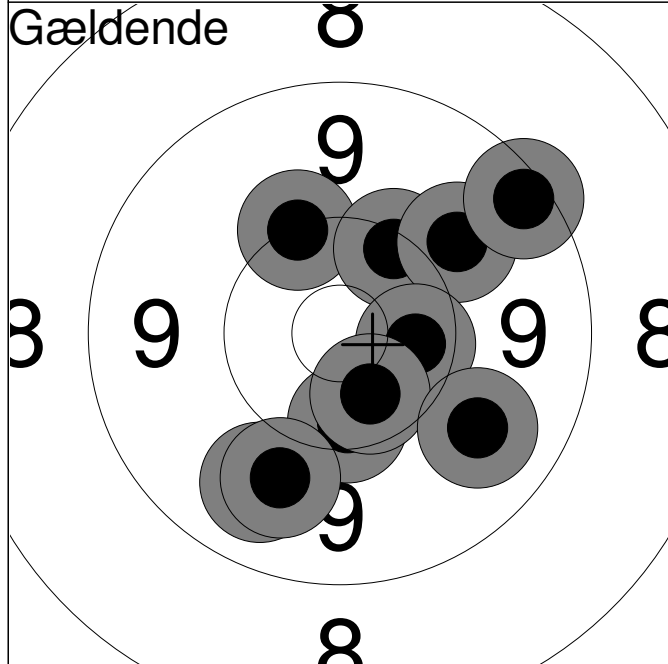

1:	9.8	↙
2:	10.2	↗
3:	10.3	↓
4:	10.3	↗
5:	9.9	↗
6:	*10.4	→
7:	*10.5	↓
8:	9.8	↘
9:	9.9	↓
10:	9.3	↗
Serie		95.0
Total		95.0

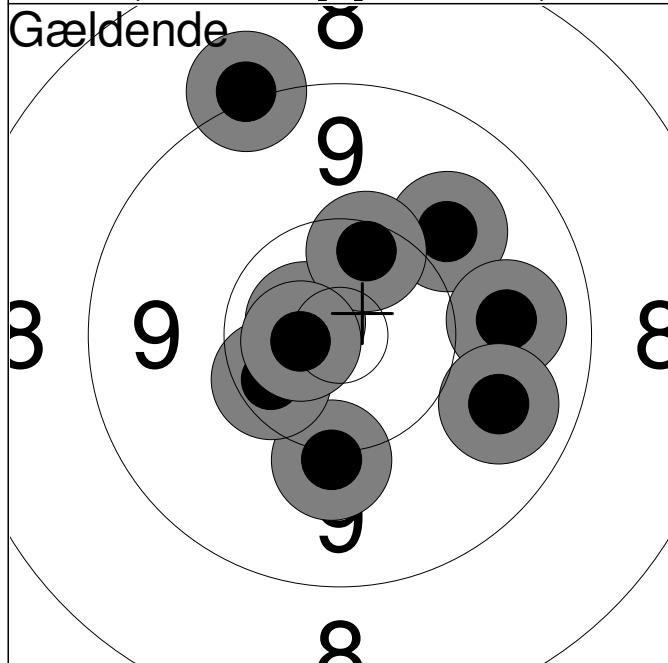

11:	9.9	↗
12:	9.8	→
13:	*10.7	←
14:	10.4	↗
15:	10.1	↓
16:	10.4	←
17:	*10.7	←
18:	9.1	↗
19:	9.8	↘
Serie		86.0
Total		181.0

Hold 55	Skive 10	Dennis Nielsen	
-------------------	--------------------	-----------------------	--

50m	Hjørring Skytteforening	2
-----	-------------------------	---

Nordjysk Mesterskab 2013	Aalborg Skyttekreds
--------------------------	---------------------

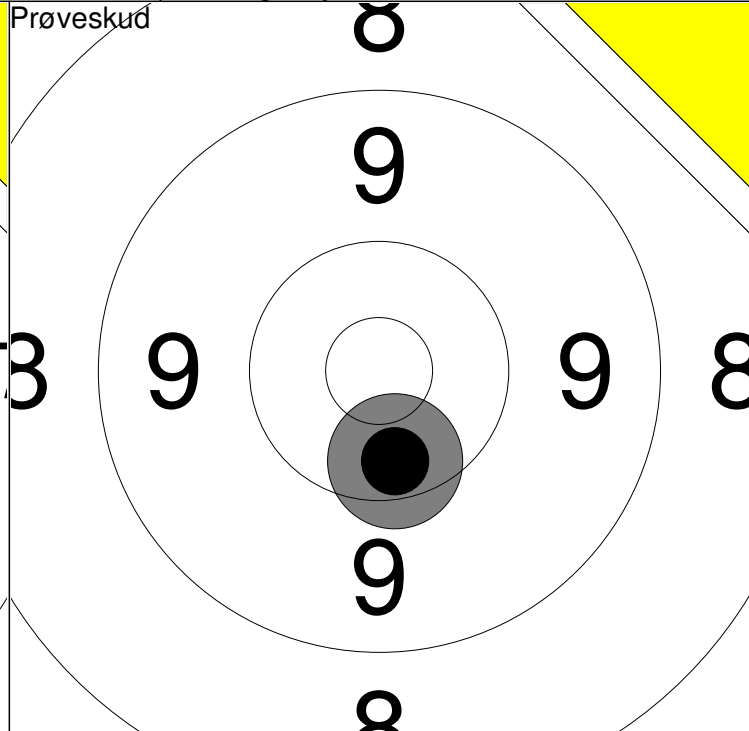
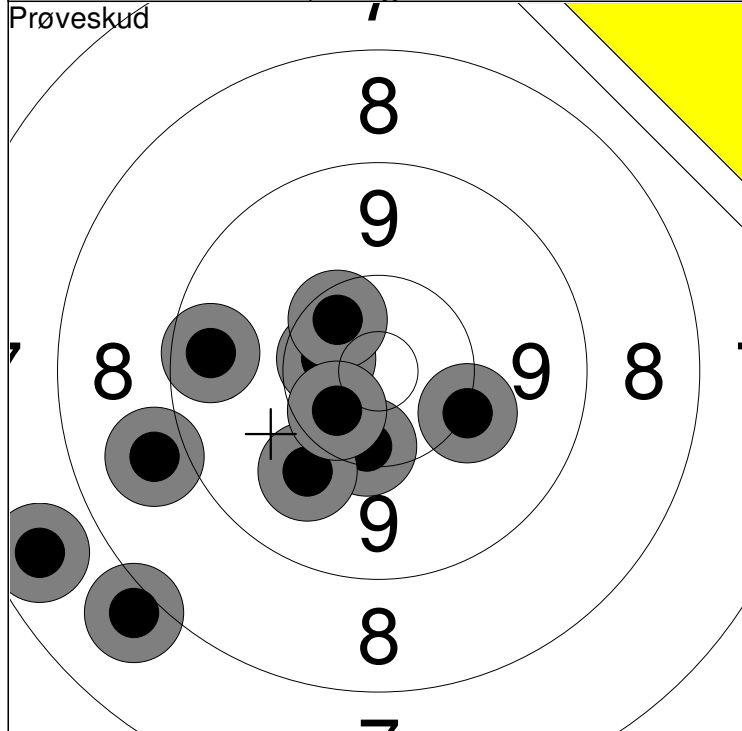

1: 8.0 ↙	6: 9.5 ←	Serie 91
2: 8.9 ←	7: 10.3 ↓	
3: 7.6 ↙	8: 9.9 ↙	Total 0
4: 10.1 →	9: 10.4 ↗	
5: *10.5 ↙	10: *10.5 ↙	

11: 10.4 ↓	Serie 10
	Total 0

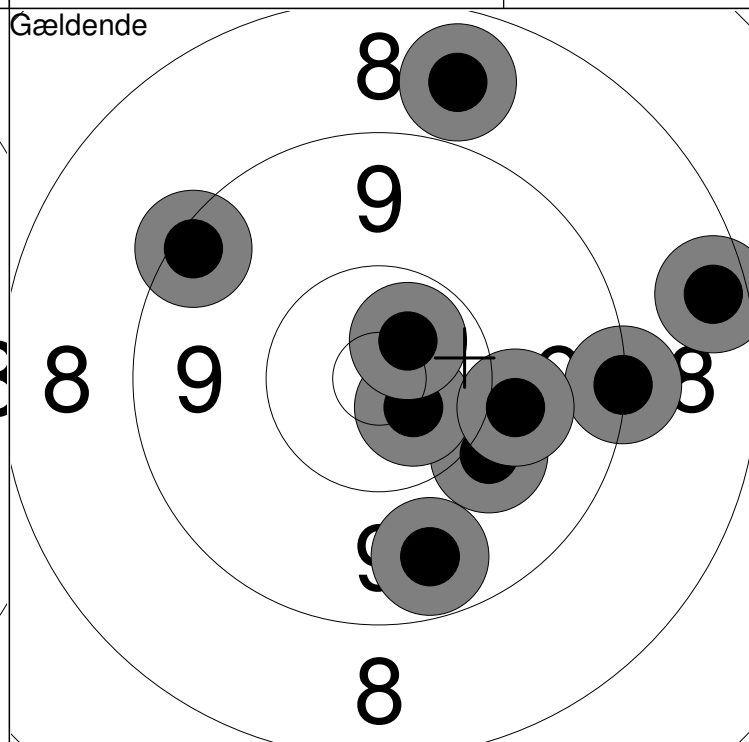
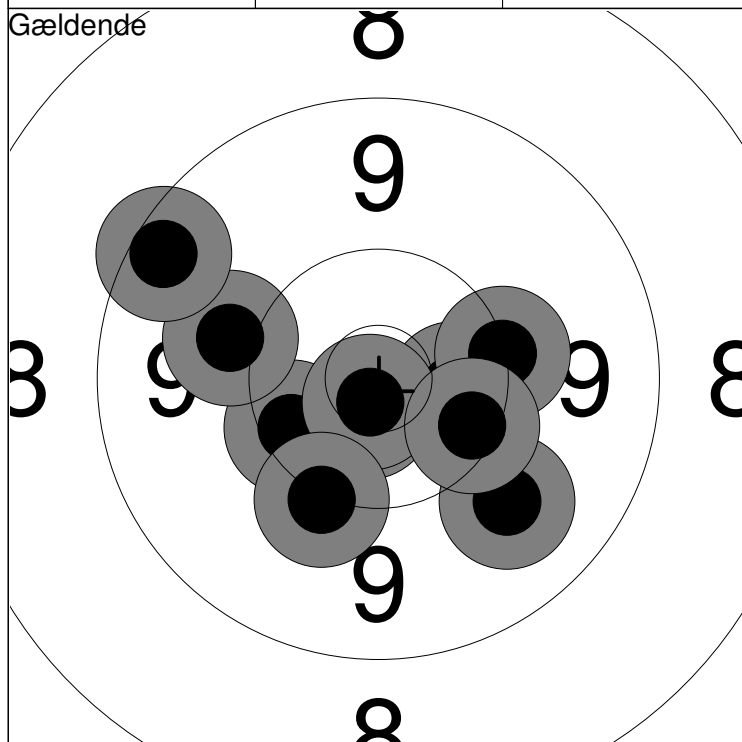

1: *10.7 ↓	6: *10.8 ↓	Serie 98
2: *10.5 →	7: 10.1 ↓	
3: 10.2 →	8: 10.3 →	Total 98
4: 9.9 ↘	9: 10.0 ←	
5: 10.3 ↙	10: 9.4 ↖	

11: 9.3 ↖	16: 10.0 ↘	Serie 83
12: 8.4 →	17: *10.6 ↘	
13: 9.2 →	18: *10.6 ↗	Total 181
14: 9.6 ↓	19: 10.0 →	
15: 8.7 ↑		

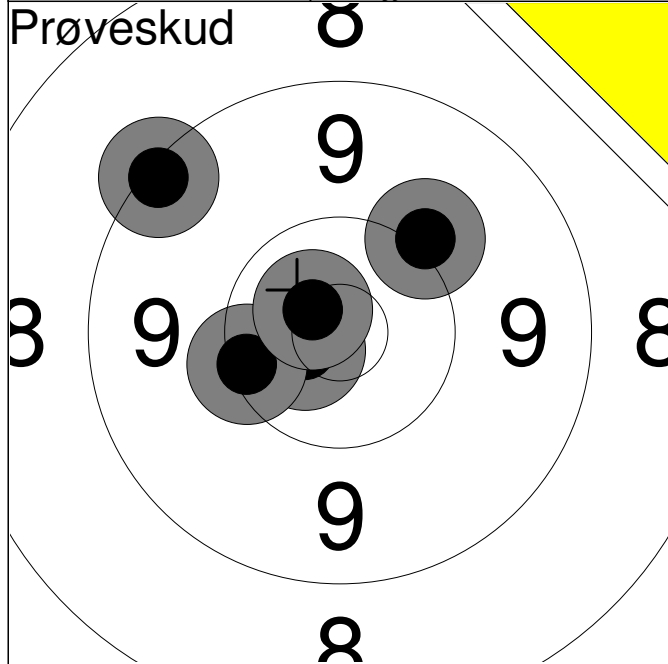

1:	9.3	↗
2:	10.1	↗
3:	*10.7	↖
4:	10.3	↖
5:	*10.7	↗
Serie		49.0
Total		0.0

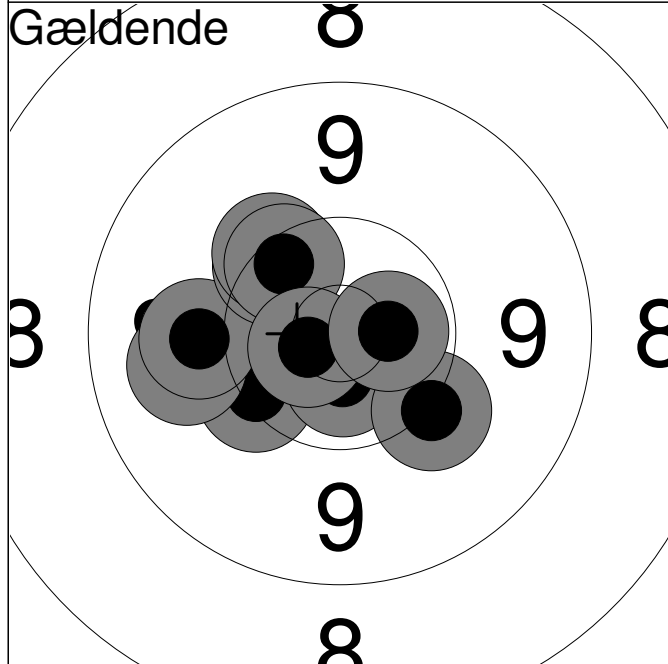

1:	10.2	↖
2:	*10.7	↓
3:	9.9	↖
4:	10.0	↖
5:	10.3	↗
6:	10.2	↗
7:	10.3	↗
8:	10.1	↘
9:	*10.7	↖
10:	*10.6	→
Serie		99.0
Total		99.0

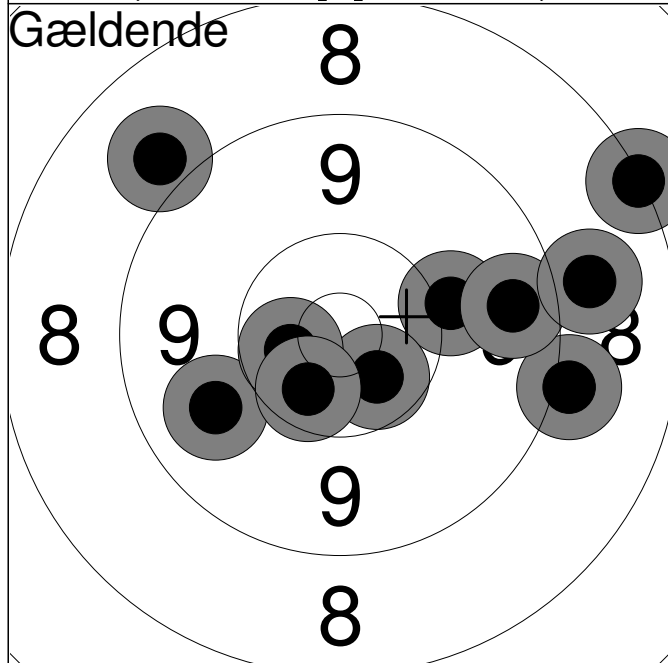

11:	9.1	→
12:	8.9	↗
13:	10.1	→
14:	*10.5	↘
15:	8.2	↗
16:	9.6	→
17:	9.8	↖
18:	*10.5	↖
19:	*10.5	↘
20:	8.9	→
Serie		91.0
Total		190.0

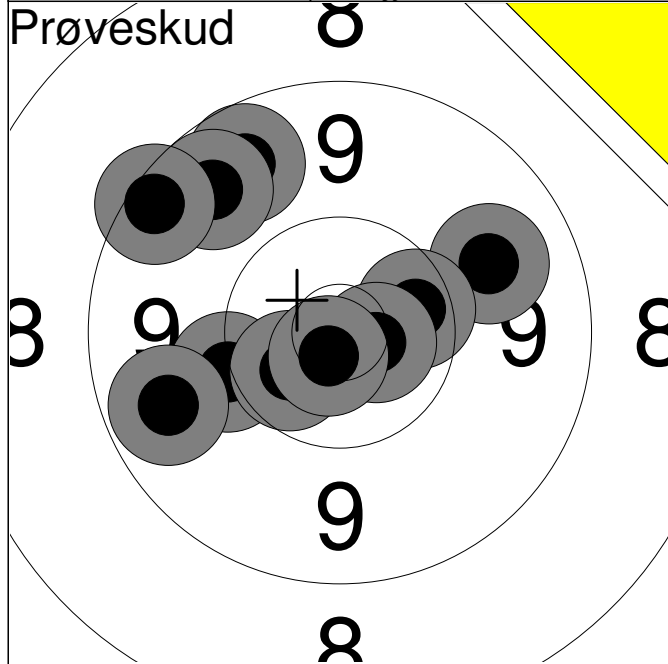

1:	9.8	↗
2:	10.1	↖
3:	9.6	↗
4:	9.6	↗
5:	10.4	→
6:	*10.7	→
7:	9.4	↗
8:	9.7	↖
9:	*10.5	↖
10:	*10.8	↘
Serie		95.0
Total		0.0

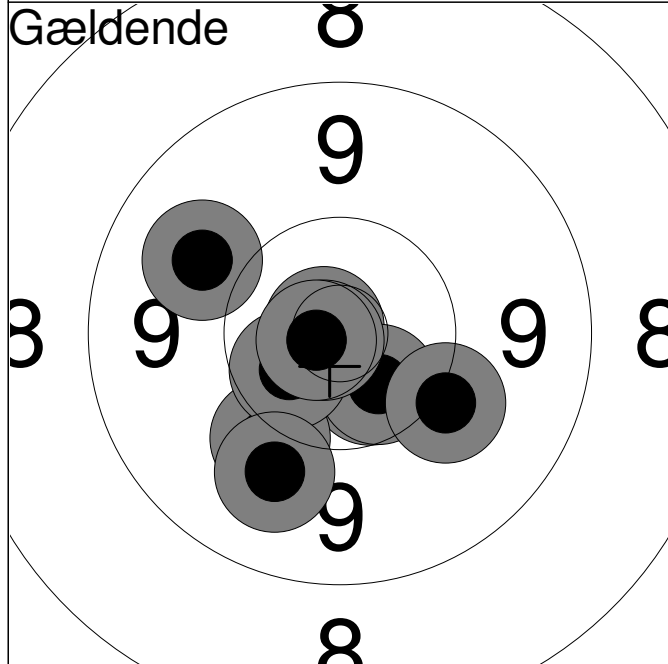

1:	*10.5	↘
2:	10.1	↘
3:	*10.8	↗
4:	9.9	↗
5:	*10.5	↘
6:	*10.5	↖
7:	9.9	↘
8:	10.1	↘
9:	*10.8	↖
10:	*10.8	↖
Serie		98.0
Total		98.0

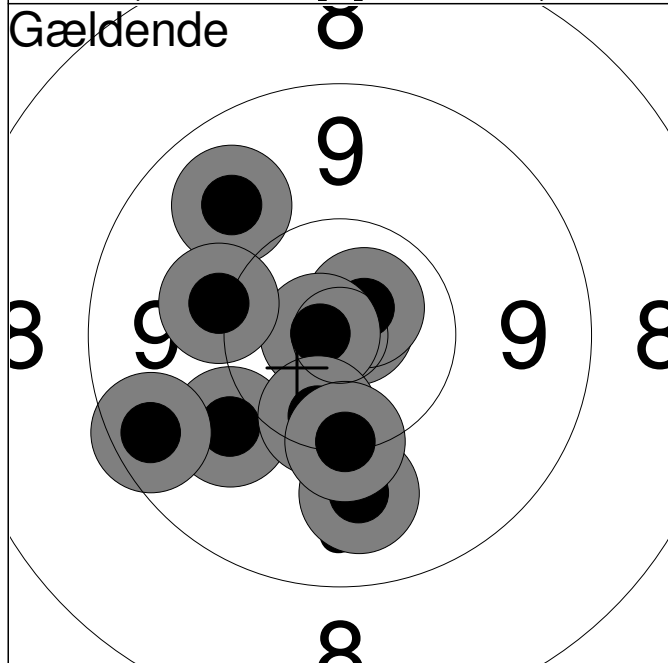

11:	*10.8	↗
12:	10.0	↖
13:	9.8	↗
14:	*10.7	↗
15:	*10.8	↖
16:	10.1	↖
17:	10.4	↘
18:	9.5	↖
19:	9.9	↘
20:	10.2	↘
Serie		97.0
Total		195.0

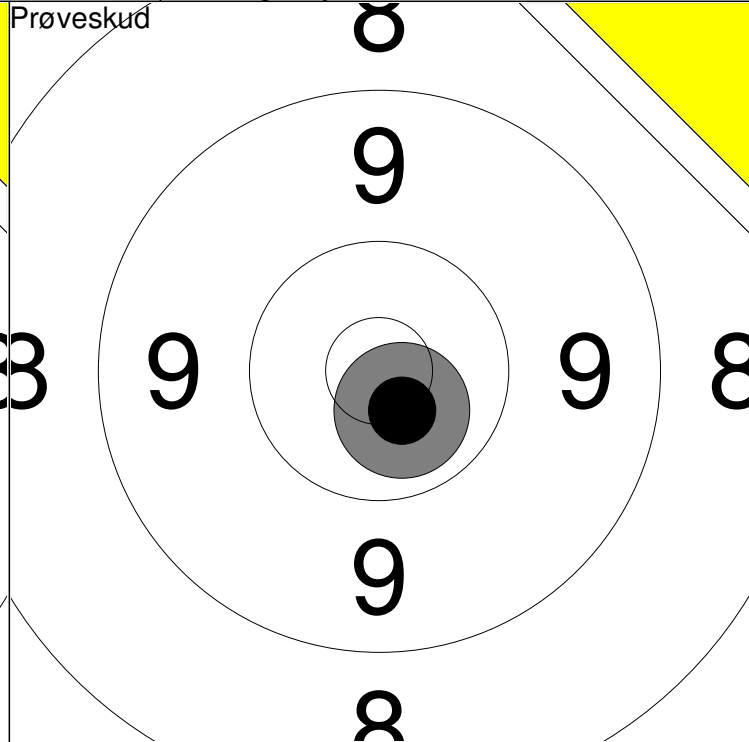
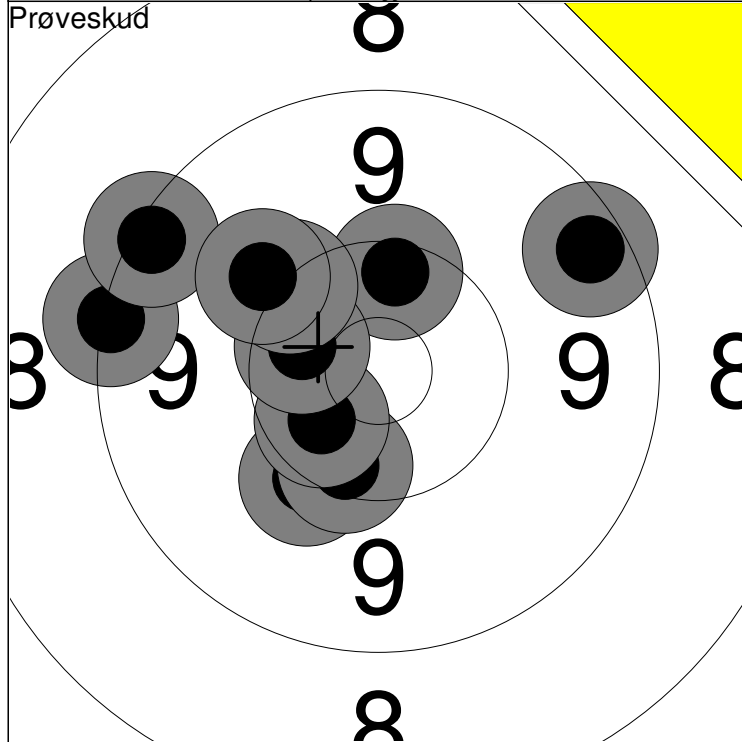

1: 9.4 ↗	6: 10.3 ↓	Serie 97
2: 9.2 ←	7: *10.5 ↙	
3: 9.3 ↖	8: *10.5 ↖	Total 0
4: 10.3 ↑	9: 10.2 ↗	
5: 10.2 ↘	10: 10.0 ↖	

11: *10.7 ↘	Serie 10
	Total 0

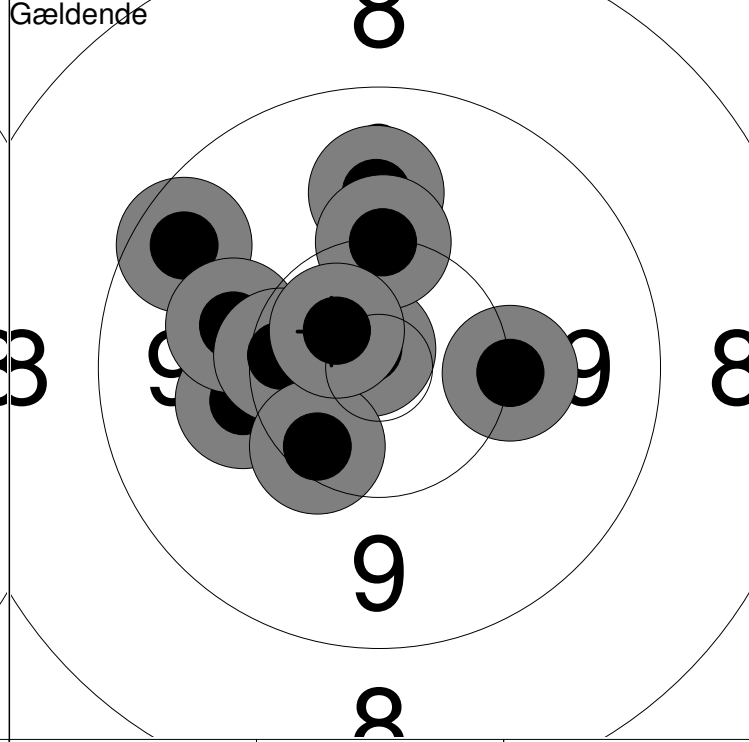
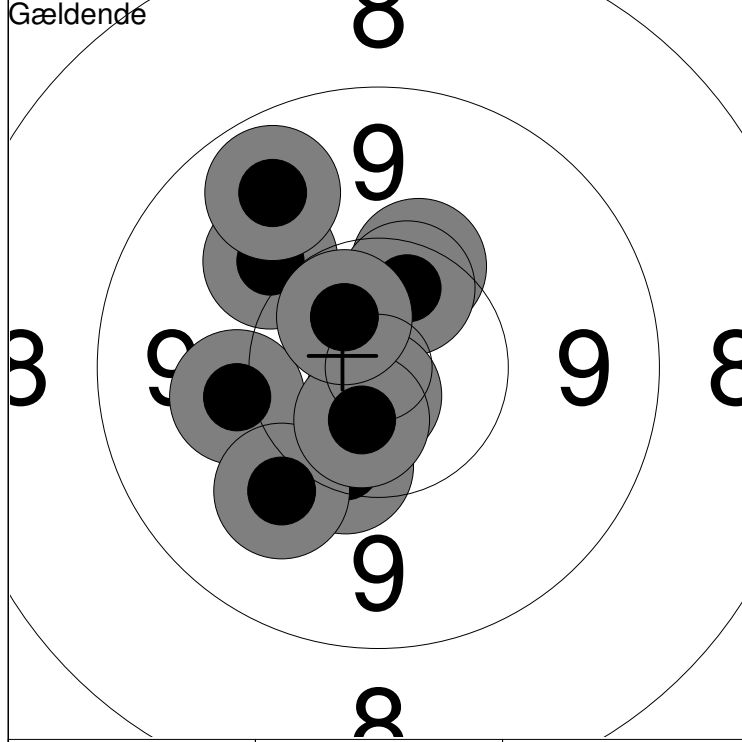

1: 10.3 ↑	6: 10.1 ←	Serie 99
2: *10.4 ↑	7: *10.8 ↓	
3: 10.0 ↖	8: 10.0 ↓	Total 99
4: 10.3 ↓	9: *10.6 ↓	
5: 9.7 ↖	10: *10.6 ↖	

11: 9.5 ↖	16: 10.0 ←	Serie 98
12: 9.9 ↑	17: 10.2 →	
13: *10.8 ↖	18: 10.3 ←	Total 197
14: 10.1 ←	19: 10.3 ↓	
15: 10.2 ↑	20: *10.6 ↖	

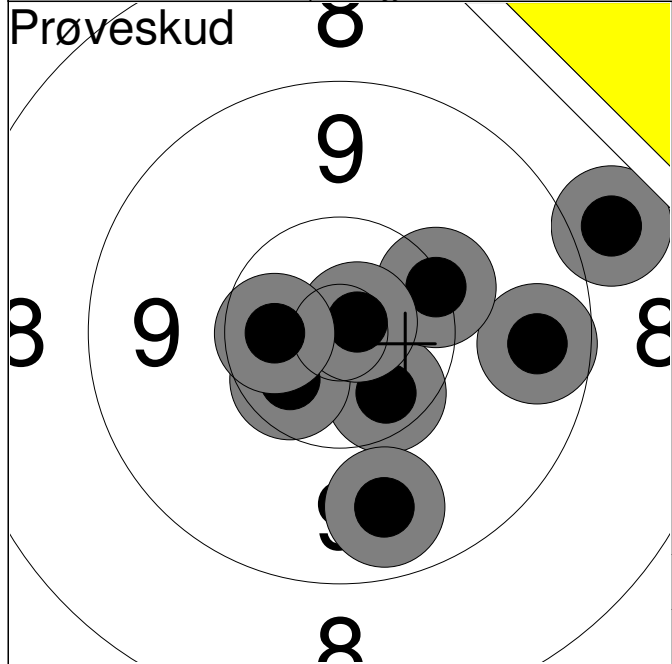

1:	8.9	→
2:	9.6	→
3:	*10.4	↘
4:	10.2	→
5:	*10.5	↙
6:	9.7	↘
7:	*10.8	→
8:	*10.5	←
Serie		76.0
Total		0.0

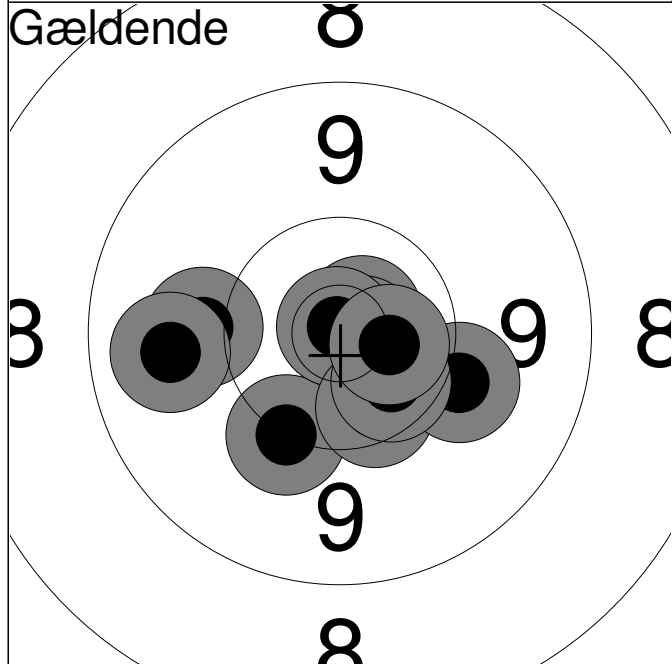

1:	10.2	↙
2:	10.0	←
3:	*10.8	→
4:	*10.8	→
5:	9.8	←
6:	*10.9	→
7:	10.4	↘
8:	10.1	↘
9:	*10.5	↘
10:	*10.6	→
Serie		99.0
Total		99.0

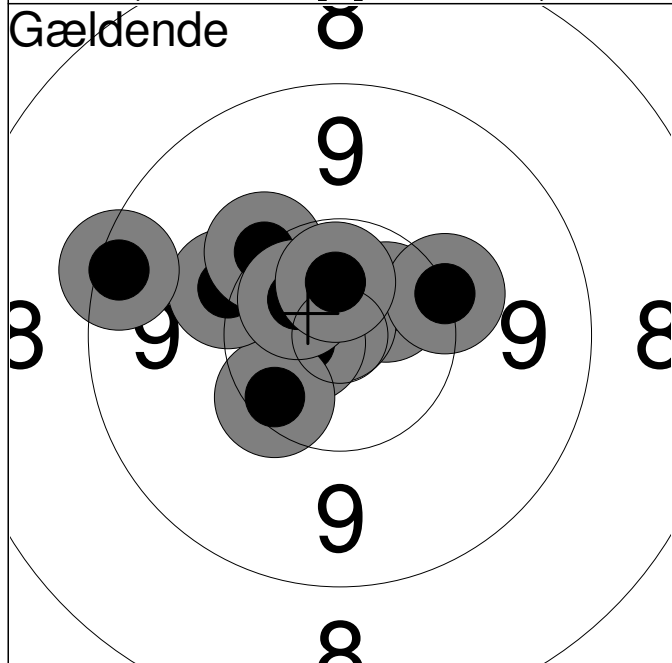

11:	*10.6	↗
12:	*10.9	↑
13:	*10.7	←
14:	10.3	↙
15:	10.1	←
16:	10.2	→
17:	10.2	↗
18:	*10.6	↗
19:	9.3	←
20:	*10.6	↑
Serie		99.0
Total		198.0

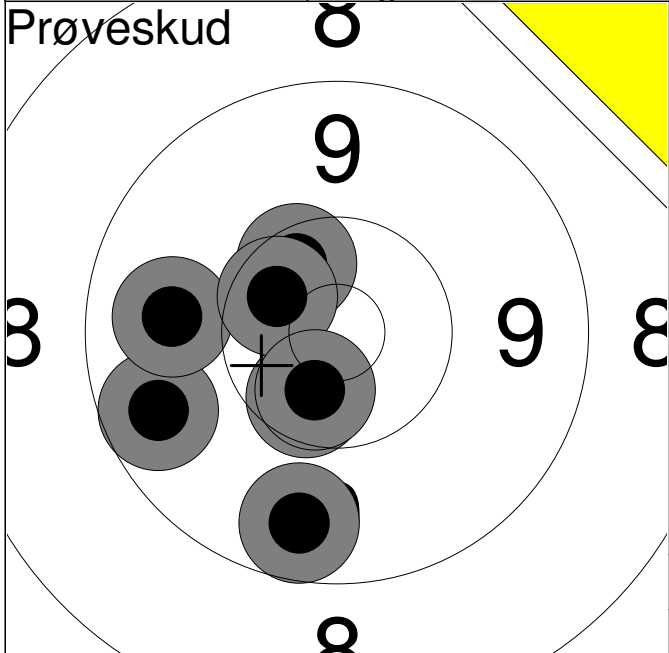
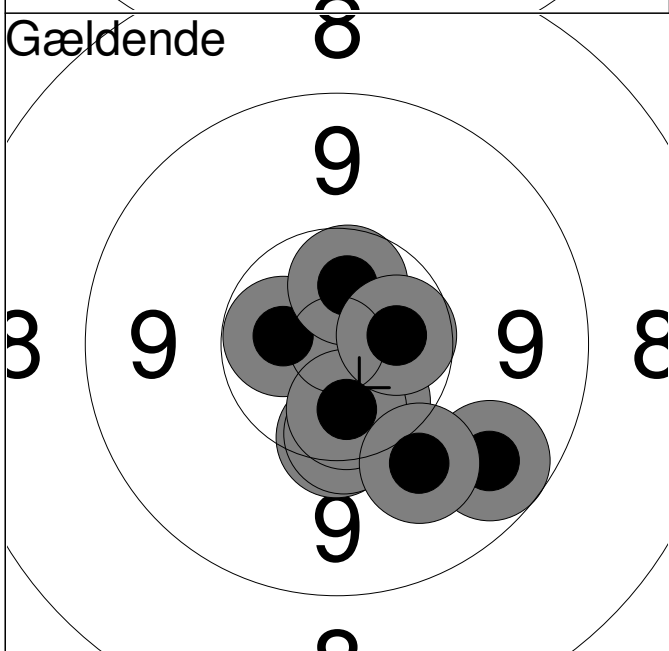
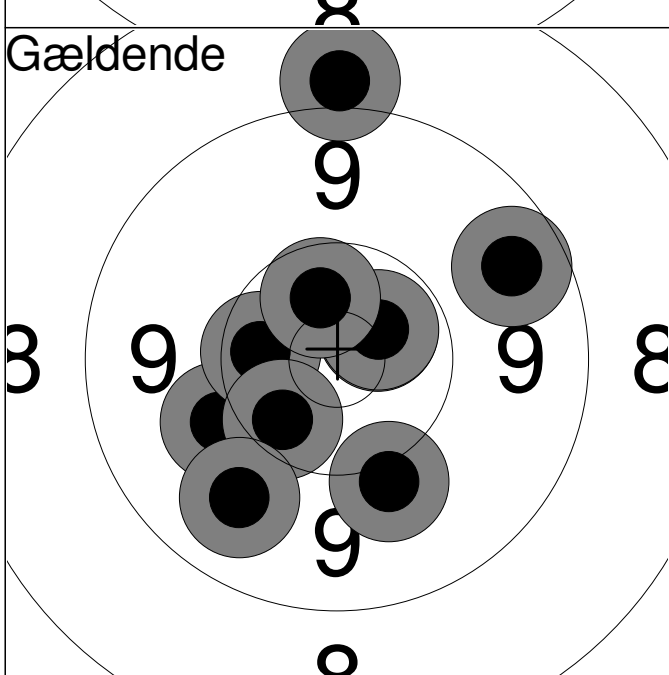
	Nordjysk Mesterskab 2013	Aalborg Skyttekreds																																		
Prøveskud 	<table style="width:100%; border-collapse: collapse;"> <tr><td style="width:10%;">1:</td><td style="width:10%;">9.6</td><td style="width:10%; text-align: right;">←</td></tr> <tr><td>2:</td><td>9.8</td><td style="text-align: right;">←</td></tr> <tr><td>3:</td><td>9.6</td><td style="text-align: right;">↓</td></tr> <tr><td>4:</td><td>*10.5</td><td style="text-align: right;">↓</td></tr> <tr><td>5:</td><td>10.4</td><td style="text-align: right;">↗</td></tr> <tr><td>6:</td><td>*10.5</td><td style="text-align: right;">↗</td></tr> <tr><td>7:</td><td>*10.5</td><td style="text-align: right;">↓</td></tr> </table>	1:	9.6	←	2:	9.8	←	3:	9.6	↓	4:	*10.5	↓	5:	10.4	↗	6:	*10.5	↗	7:	*10.5	↓	<table style="width:100%; border-collapse: collapse;"> <tr><td style="width:80%;">Serie</td><td style="text-align: right;">67.0</td></tr> <tr><td>Total</td><td style="text-align: right;">0.0</td></tr> </table>	Serie	67.0	Total	0.0									
1:	9.6	←																																		
2:	9.8	←																																		
3:	9.6	↓																																		
4:	*10.5	↓																																		
5:	10.4	↗																																		
6:	*10.5	↗																																		
7:	*10.5	↓																																		
Serie	67.0																																			
Total	0.0																																			
Gældende 	<table style="width:100%; border-collapse: collapse;"> <tr><td style="width:10%;">1:</td><td style="width:10%;">*10.8</td><td style="width:10%; text-align: right;">↘</td></tr> <tr><td>2:</td><td>*10.6</td><td style="text-align: right;">←</td></tr> <tr><td>3:</td><td>10.3</td><td style="text-align: right;">↓</td></tr> <tr><td>4:</td><td>10.3</td><td style="text-align: right;">↓</td></tr> <tr><td>5:</td><td>*10.5</td><td style="text-align: right;">↓</td></tr> <tr><td>6:</td><td>*10.5</td><td style="text-align: right;">↓</td></tr> <tr><td>7:</td><td>9.6</td><td style="text-align: right;">↓</td></tr> <tr><td>8:</td><td>10.0</td><td style="text-align: right;">↓</td></tr> <tr><td>9:</td><td>*10.5</td><td style="text-align: right;">↑</td></tr> <tr><td>10:</td><td>*10.5</td><td style="text-align: right;">→</td></tr> </table>	1:	*10.8	↘	2:	*10.6	←	3:	10.3	↓	4:	10.3	↓	5:	*10.5	↓	6:	*10.5	↓	7:	9.6	↓	8:	10.0	↓	9:	*10.5	↑	10:	*10.5	→	<table style="width:100%; border-collapse: collapse;"> <tr><td style="width:80%;">Serie</td><td style="text-align: right;">99.0</td></tr> <tr><td>Total</td><td style="text-align: right;">99.0</td></tr> </table>	Serie	99.0	Total	99.0
1:	*10.8	↘																																		
2:	*10.6	←																																		
3:	10.3	↓																																		
4:	10.3	↓																																		
5:	*10.5	↓																																		
6:	*10.5	↓																																		
7:	9.6	↓																																		
8:	10.0	↓																																		
9:	*10.5	↑																																		
10:	*10.5	→																																		
Serie	99.0																																			
Total	99.0																																			
Gældende 	<table style="width:100%; border-collapse: collapse;"> <tr><td style="width:10%;">11:</td><td style="width:10%;">10.0</td><td style="width:10%; text-align: right;">↓</td></tr> <tr><td>12:</td><td>*10.6</td><td style="text-align: right;">↗</td></tr> <tr><td>13:</td><td>10.0</td><td style="text-align: right;">←</td></tr> <tr><td>14:</td><td>*10.6</td><td style="text-align: right;">↗</td></tr> <tr><td>15:</td><td>*10.4</td><td style="text-align: right;">←</td></tr> <tr><td>16:</td><td>9.6</td><td style="text-align: right;">↗</td></tr> <tr><td>17:</td><td>10.4</td><td style="text-align: right;">↘</td></tr> <tr><td>18:</td><td>9.8</td><td style="text-align: right;">↘</td></tr> <tr><td>19:</td><td>*10.5</td><td style="text-align: right;">↑</td></tr> <tr><td>20:</td><td>9.0</td><td style="text-align: right;">↑</td></tr> </table>	11:	10.0	↓	12:	*10.6	↗	13:	10.0	←	14:	*10.6	↗	15:	*10.4	←	16:	9.6	↗	17:	10.4	↘	18:	9.8	↘	19:	*10.5	↑	20:	9.0	↑	<table style="width:100%; border-collapse: collapse;"> <tr><td style="width:80%;">Serie</td><td style="text-align: right;">97.0</td></tr> <tr><td>Total</td><td style="text-align: right;">196.0</td></tr> </table>	Serie	97.0	Total	196.0
11:	10.0	↓																																		
12:	*10.6	↗																																		
13:	10.0	←																																		
14:	*10.6	↗																																		
15:	*10.4	←																																		
16:	9.6	↗																																		
17:	10.4	↘																																		
18:	9.8	↘																																		
19:	*10.5	↑																																		
20:	9.0	↑																																		
Serie	97.0																																			
Total	196.0																																			

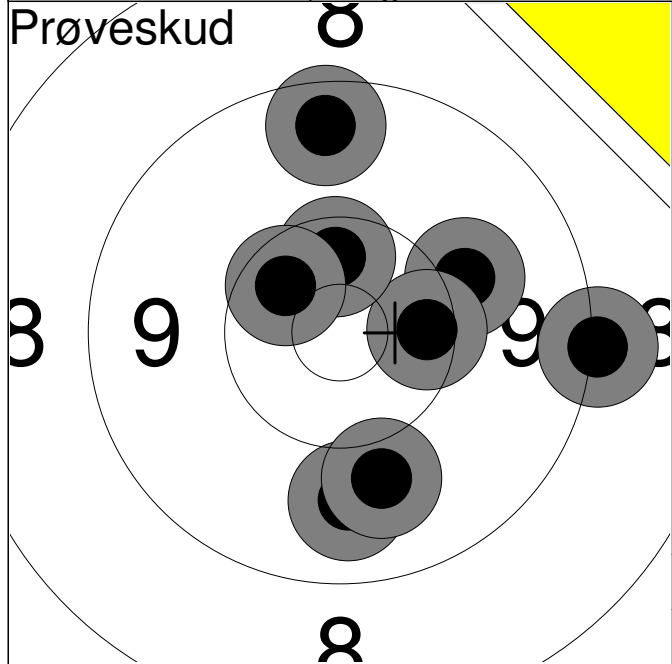

1:	9.5	↑
2:	9.8	↓
3:	9.9	↓
4:	10.0	→
5:	9.1	→
6:	10.4	→
7:	*10.4	↑
8:	*10.5	↗
Serie		76.0
Total		0.0

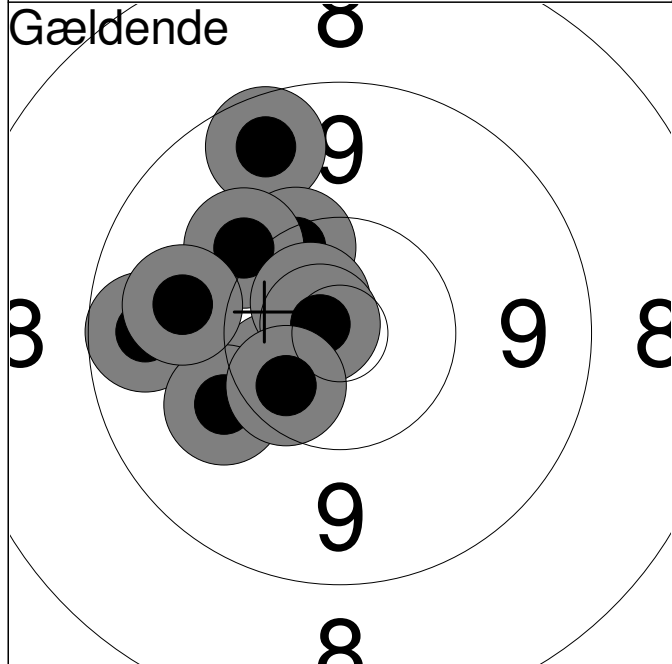

1:	9.6	←
2:	9.5	↗
3:	10.3	↗
4:	*10.4	←
5:	10.1	↗
6:	10.0	←
7:	*10.7	↗
8:	*10.8	↗
9:	*10.4	↘
10:	9.9	←
Serie		97.0
Total		97.0

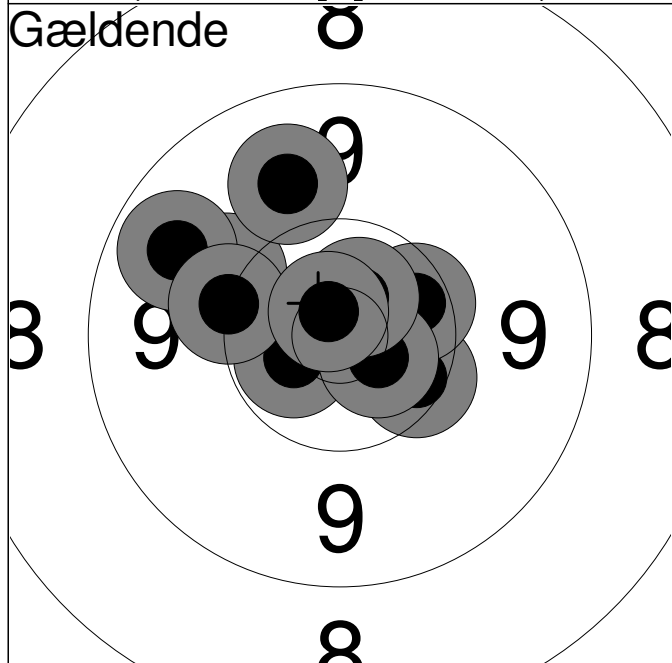

11:	10.3	↘
12:	10.1	↗
13:	*10.6	←
14:	9.7	↗
15:	10.2	←
16:	10.4	→
17:	9.9	↗
18:	*10.6	↘
19:	*10.7	↗
20:	*10.8	↗
Serie		98.0
Total		195.0

Hold 56	Skive 5	Martin Jensen	
-------------------	-------------------	----------------------	--

50m	Løgstør Sportsskytteklub	MJ1	
-----	--------------------------	-----	--

	Nordjysk Mesterskab 2013	Aalborg Skyttekreds	
--	--------------------------	---------------------	--

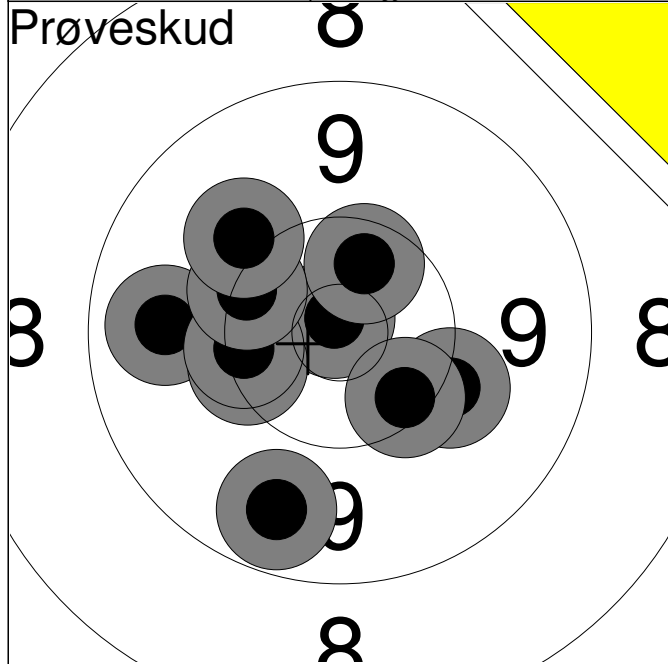

1:	9.7	←
2:	*10.8	↑
3:	*10.5	↑
4:	10.3	←
5:	10.3	←
6:	10.1	↓
7:	9.6	↓
8:	10.2	↑
9:	10.0	↑
10:	10.3	↓
Serie		98.0
Total		0.0

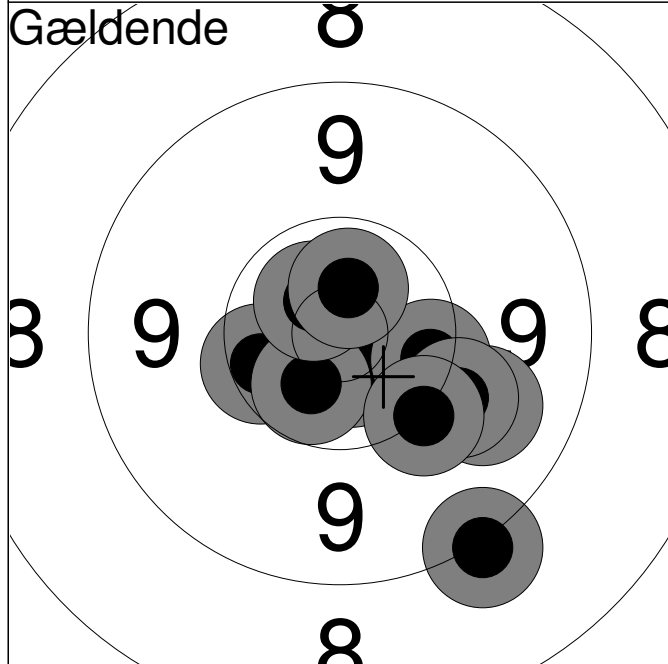

1:	9.8	↓
2:	*10.7	↓
3:	10.4	←
4:	*10.6	↓
5:	10.3	→
6:	*10.7	↑
7:	*10.6	↑
8:	10.0	↓
9:	9.1	↓
10:	10.1	↓
Serie		98.0
Total		98.0

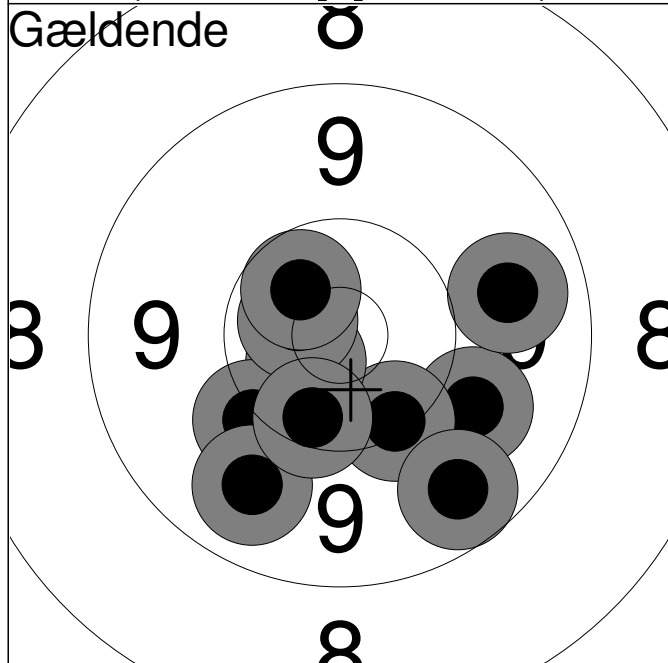

11:	9.9	↓
12:	10.3	↓
13:	*10.7	←
14:	9.6	↓
15:	9.8	→
16:	10.1	←
17:	*10.6	↑
18:	9.8	↓
19:	10.4	↓
20:	*10.5	↑
Serie		96.0
Total		194.0

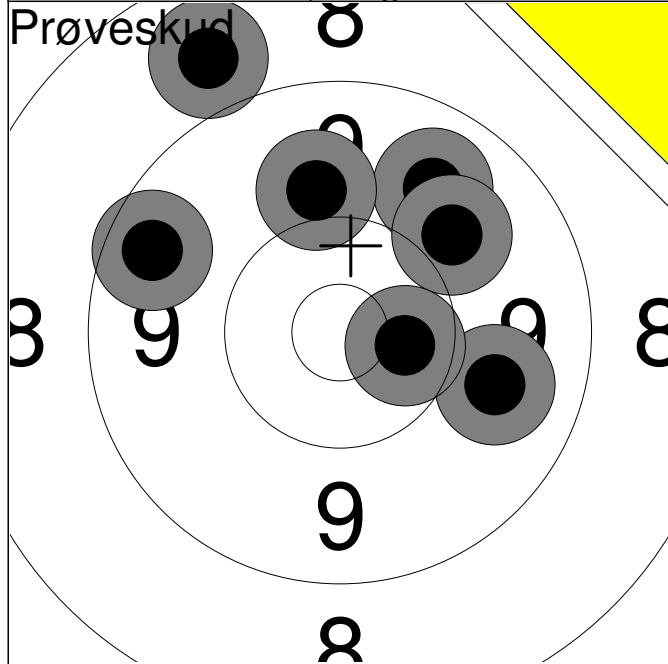

1:	9.5	↗
2:	8.8	↗
3:	9.8	↗
4:	9.9	↗
5:	9.8	↘
6:	10.0	↗
7:	*10.5	↘
Serie		64.0
Total		0.0

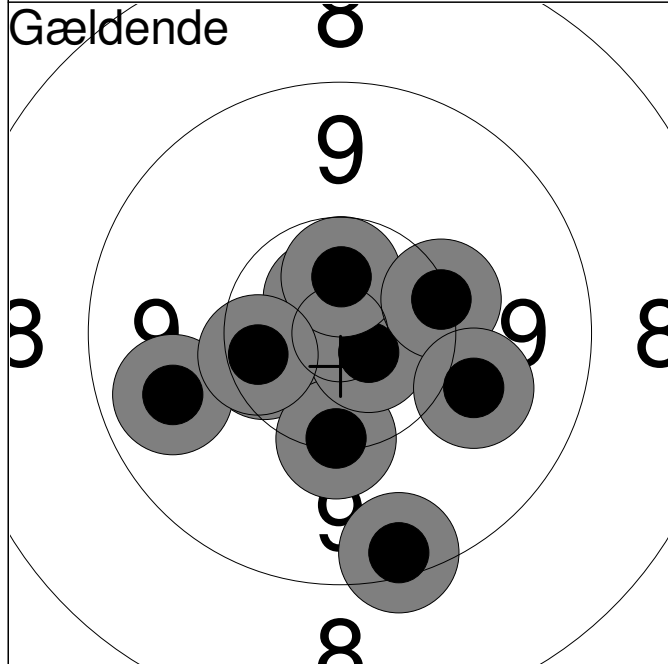

1:	9.4	↓
2:	10.4	←
3:	10.2	↓
4:	*10.7	↗
5:	*10.7	↘
6:	*10.6	↑
7:	10.2	→
8:	9.7	←
9:	10.0	→
10:	10.4	←
Serie		98.0
Total		98.0

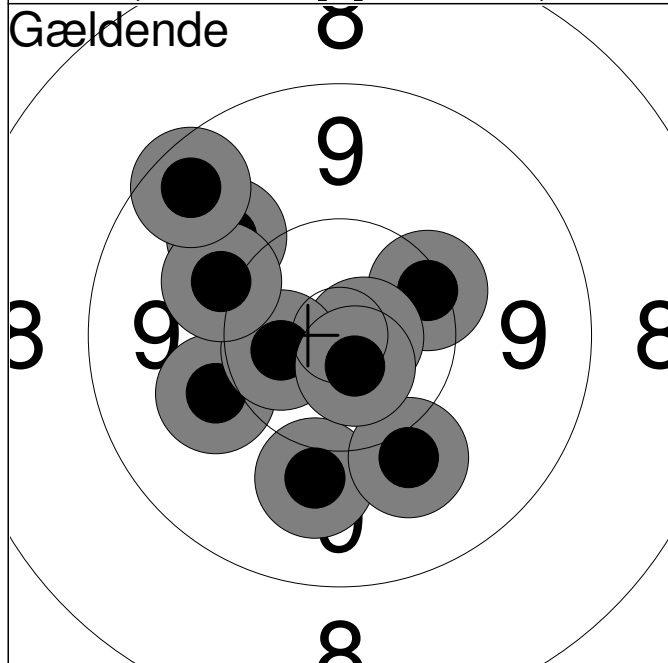

11:	10.0	↓
12:	10.0	↓
13:	10.3	↗
14:	*10.8	→
15:	9.9	↗
16:	10.0	←
17:	*10.5	←
18:	10.1	↗
19:	*10.7	↓
20:	9.5	↗
Serie		98.0
Total		196.0

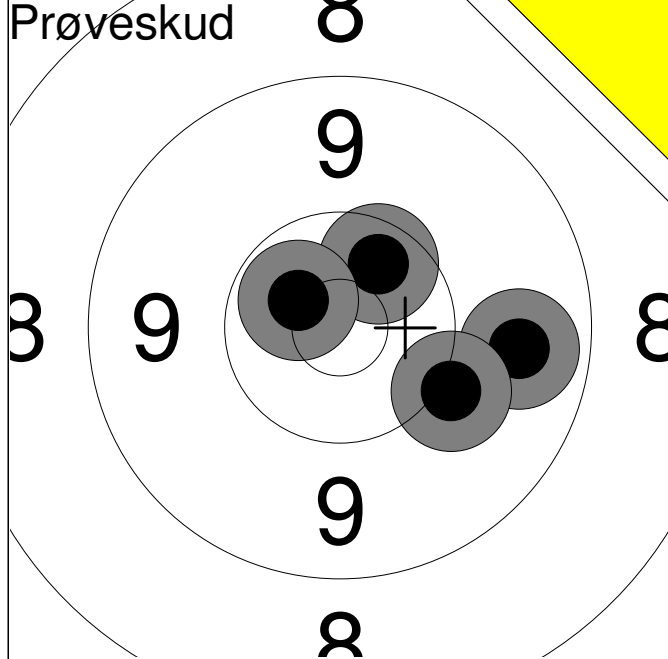

1:	9.7	→
2:	10.1	→
3:	*10.4	↗
4:	*10.6	↗
Serie		39.0
Total		0.0

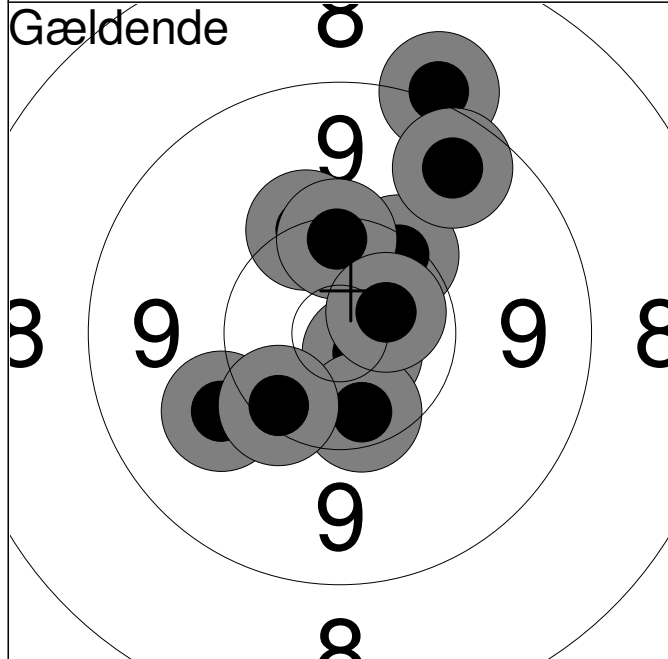

1:	10.0	↙
2:	10.3	↗
3:	*10.7	↘
4:	9.1	↗
5:	9.6	↗
6:	10.4	↘
7:	10.2	↗
8:	10.3	↙
9:	10.3	↗
10:	*10.6	↗
Serie		98.0
Total		98.0

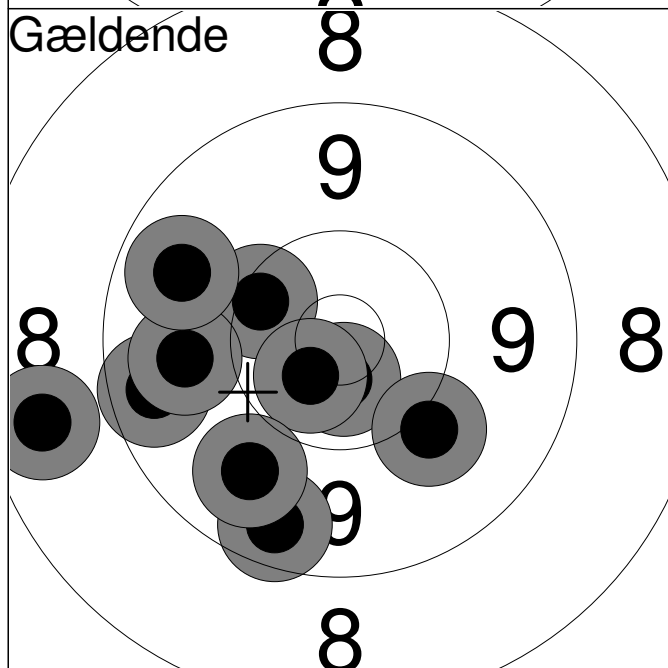

11:	10.3	↙
12:	9.5	↙
13:	8.6	↙
14:	*10.7	↘
15:	9.8	↙
16:	9.5	↘
17:	9.7	↙
18:	*10.6	↙
19:	9.8	↘
20:	10.0	↘
Serie		93.0
Total		191.0

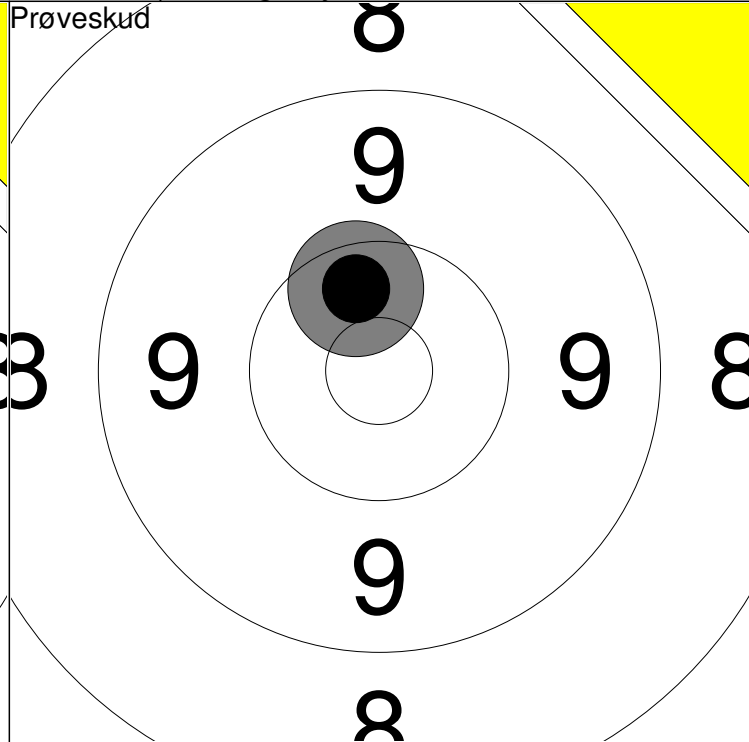
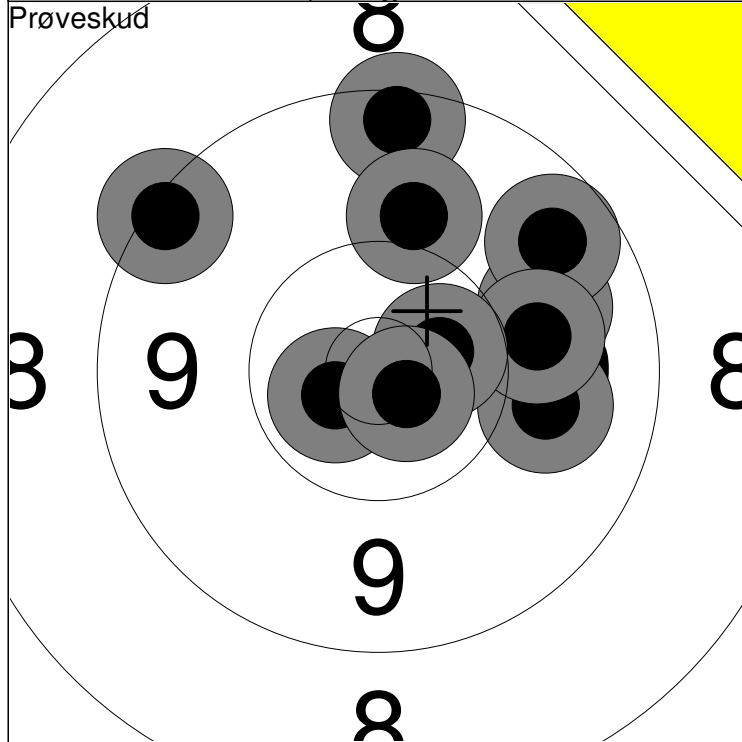

1: *10.6 ↙	6: 10.0 ↑	Serie	95
2: 9.9 →	7: 10.0 →		
3: 9.6 ↗	8: *10.6 →	Total	0
4: 9.9 →	9: 9.3 ↖		
5: 9.4 ↑	10: *10.7 ↘		

11: *10.4 ↑	Serie	10
	Total	0

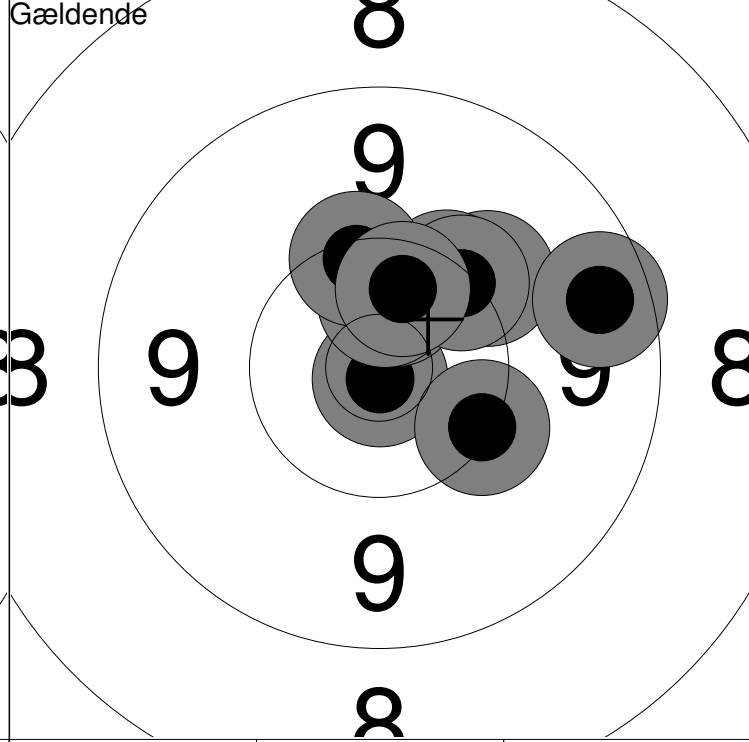
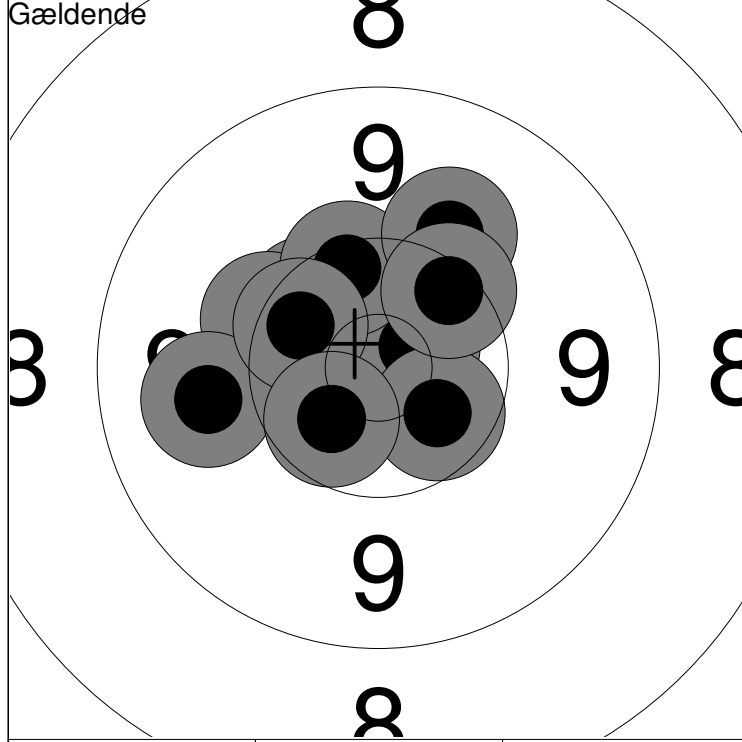

1: 10.4 ↖	6: 10.4 ↖	Serie	99
2: 10.2 ↖	7: *10.5 ↘		
3: *10.7 ↗	8: 10.0 ↑	Total	99
4: 9.9 ←	9: *10.5 ↙		
5: 10.3 ↑	10: 10.3 ↗		

11: *10.9 ↓	16: 10.2 ↗	Serie	99
12: *10.5 ↑	17: 9.5 →		
13: 10.1 ↗	18: 10.3 ↑	Total	198
14: 10.3 ↗	19: *10.4 ↑		
15: *10.5 ↑	20: 10.2 ↘		

Hold 56	Skive 10	Nicklas Bundgaard	
-------------------	--------------------	--------------------------	--

50m	Vadum Skf.	MB1	
-----	------------	-----	--

	Nordjysk Mesterskab 2013	Aalborg Skyttekreds	
--	--------------------------	---------------------	--

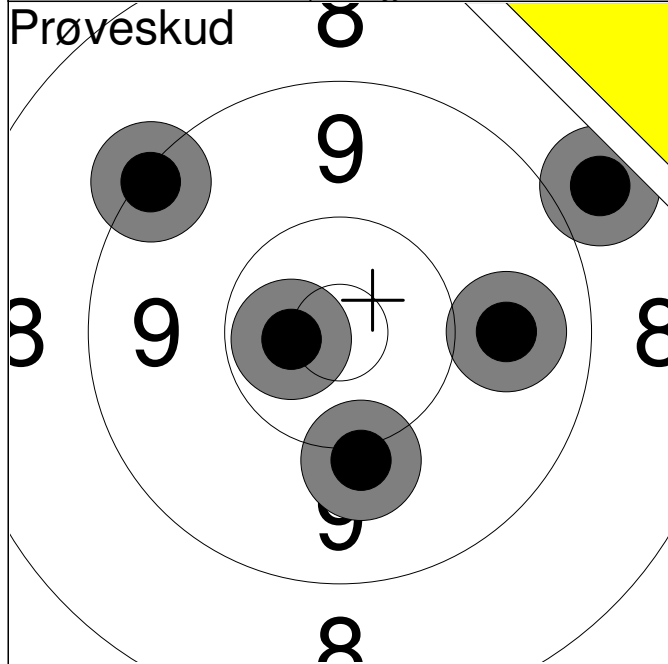

1:	8.8	↗
2:	9.2	↗
3:	9.8	→
4:	*10.6	←
5:	10.1	↓
Serie		46.0
Total		0.0

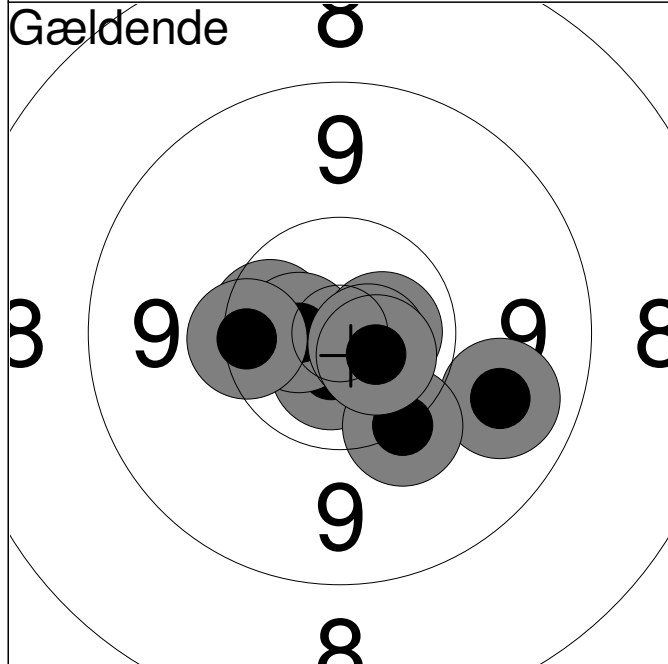

1:	*10.7	↓
2:	*10.7	↓
3:	*10.5	←
4:	*10.7	←
5:	*10.7	→
6:	*10.7	↘
7:	9.8	↘
8:	10.3	←
9:	10.2	↘
10:	*10.7	↘
Serie		99.0
Total		99.0

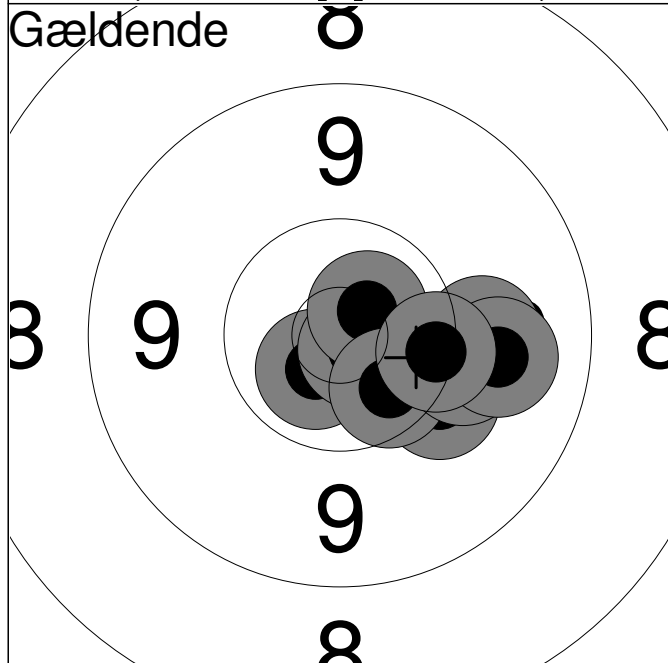

11:	*10.7	↙
12:	*10.8	↙
13:	10.0	→
14:	10.0	→
15:	10.1	↘
16:	*10.7	↗
17:	*10.5	↘
18:	10.1	→
19:	9.9	→
20:	10.3	→
Serie		99.0
Total		198.0

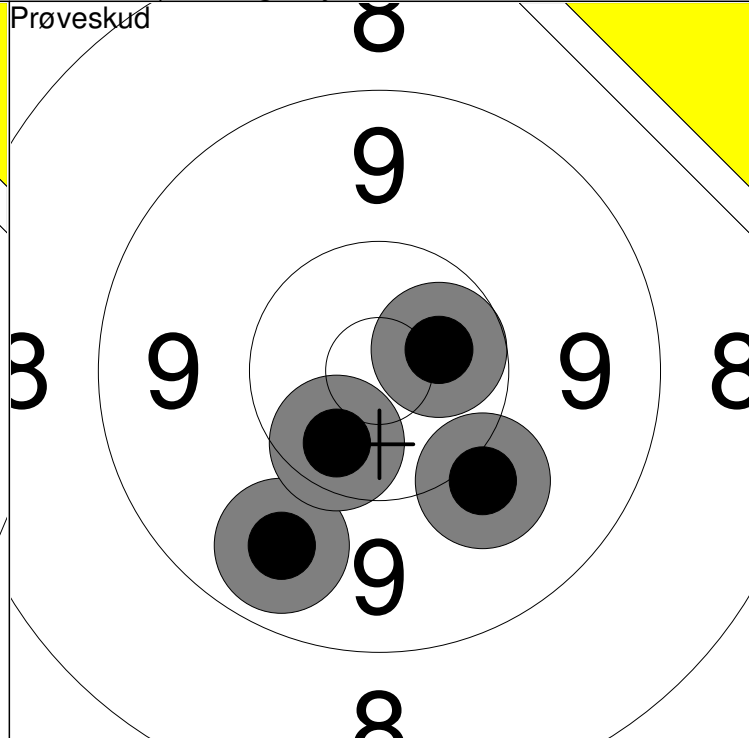
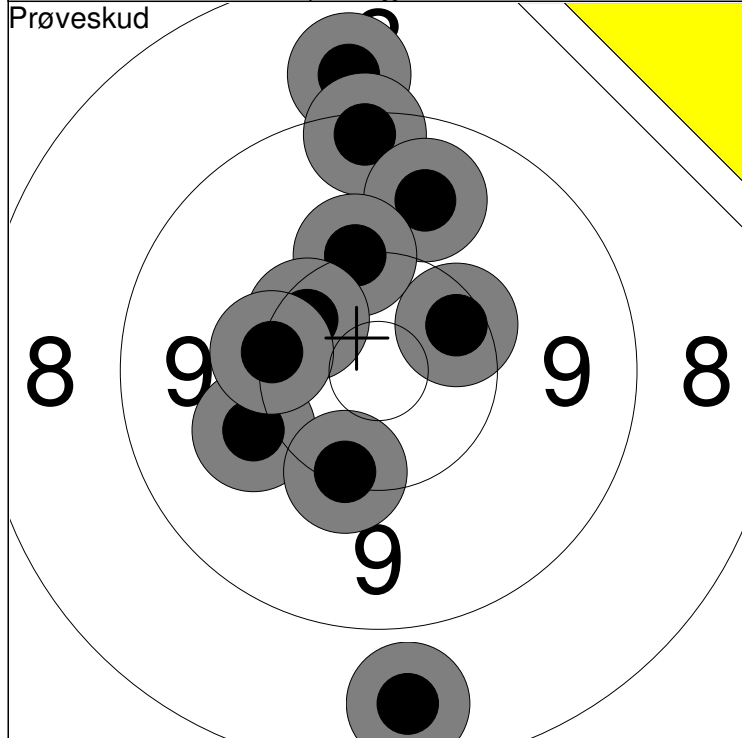

1: 8.9 ↑	6: 10.4 ↙	Serie 94
2: 10.3 ↗	7: 8.6 ↓	
3: 9.3 ↑	8: 10.0 ↙	Total 0
4: 9.8 ↑	9: 10.2 ↙	
5: 10.2 ↑	10: 10.2 ↓	

11: 9.7 ↘	Serie 39
12: *10.4 ↘	
13: 10.0 ↘	Total 0
14: *10.6 →	

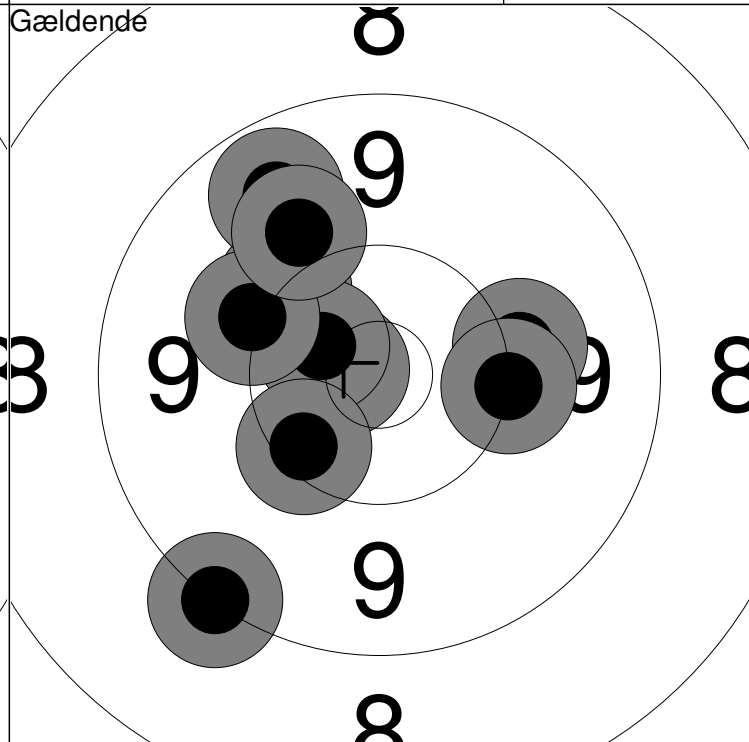
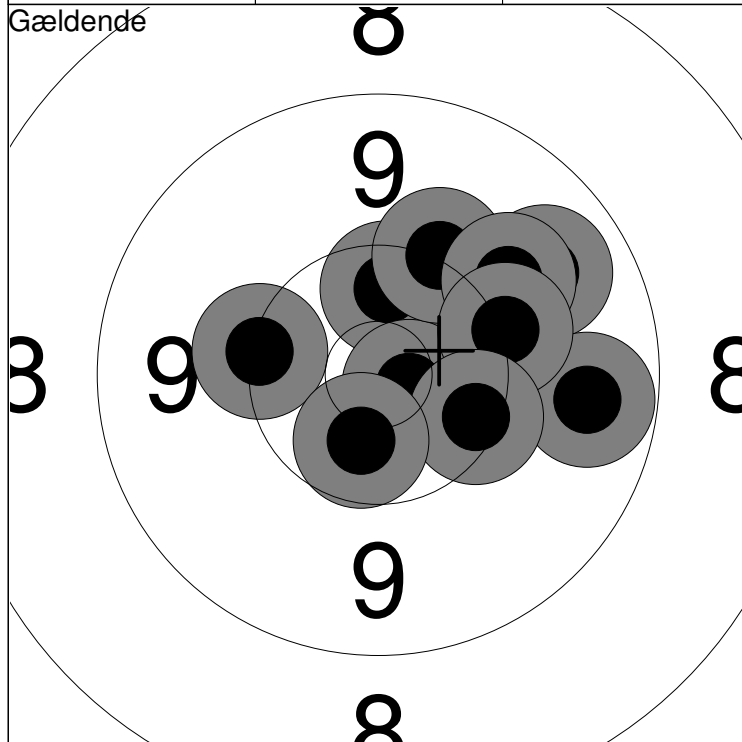

1: 9.7 ↗	6: 10.0 ↗	Serie 98
2: 10.2 ↙	7: 9.6 →	
3: *10.4 ↑	8: 10.1 →	Total 98
4: *10.7 →	9: 10.3 →	
5: 10.1 ↑	10: *10.5 ↓	

11: 10.1 →	16: *10.7 ↙	Serie 98
12: 10.2 ↙	17: *10.6 ↙	
13: 9.7 ↙	18: 10.1 ↙	Total 196
14: 9.2 ↓	19: 10.3 ↘	
15: 10.2 →	20: 10.0 ↙	

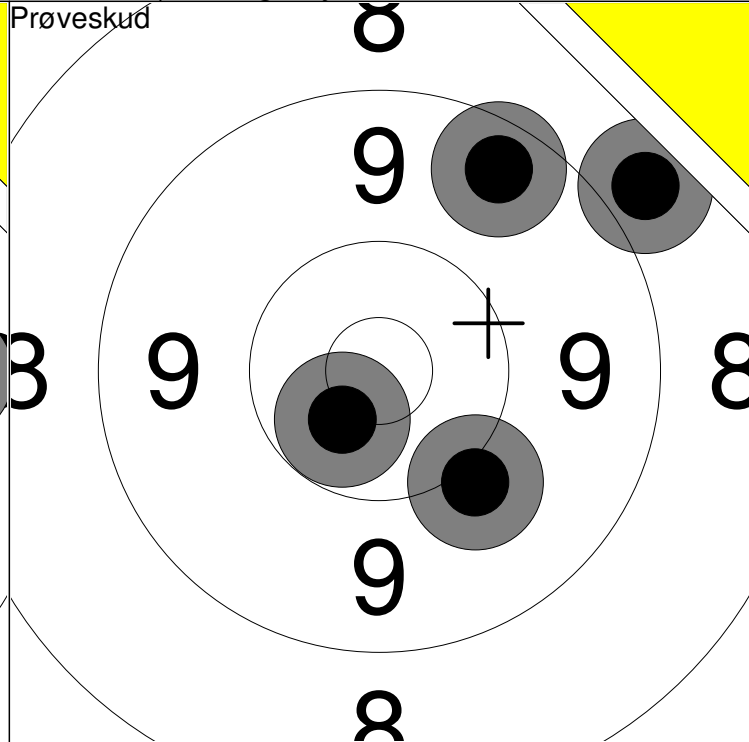
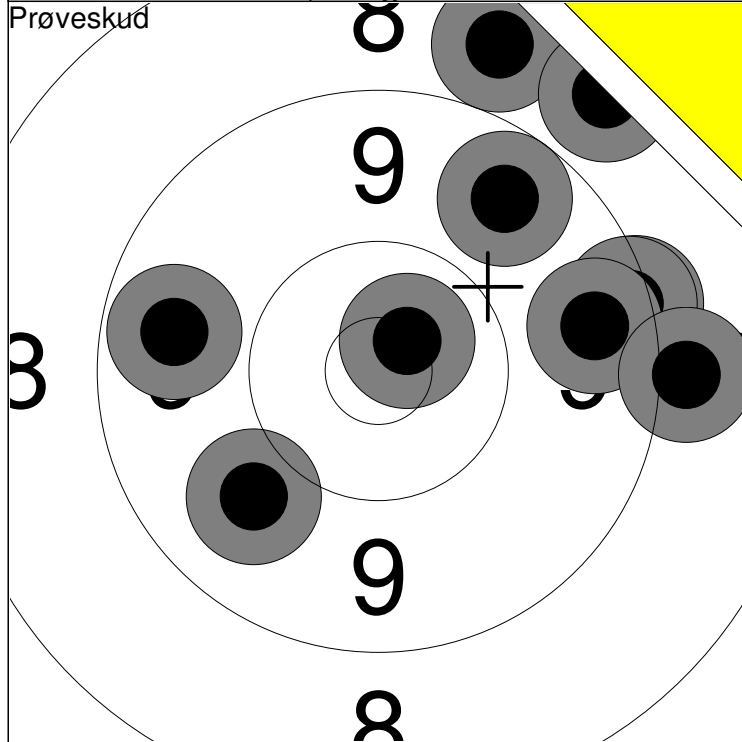

1: 8.7 ↗	6: 9.6 →	Serie	89
2: 9.9 ↘	7: 8.7 ↗		
3: 9.7 ←	8: 9.0 →	Total	0
4: 9.3 →	9: *10.7 ↗		
5: 9.3 →	10: 9.6 ↗		

11: 9.5 ↗	Serie	37
12: 8.9 ↗		
13: *10.6 ↘	Total	0
14: 10.1 ↘		

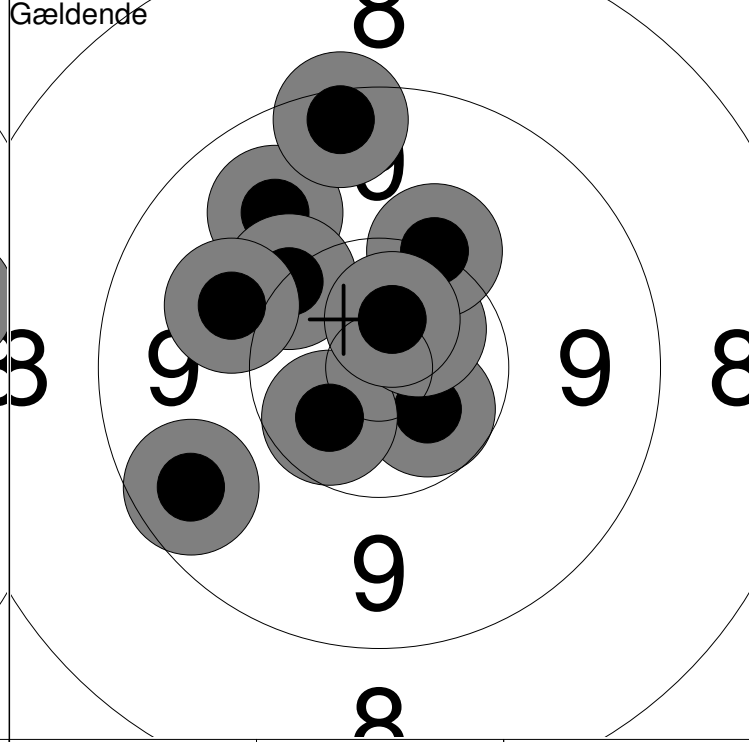
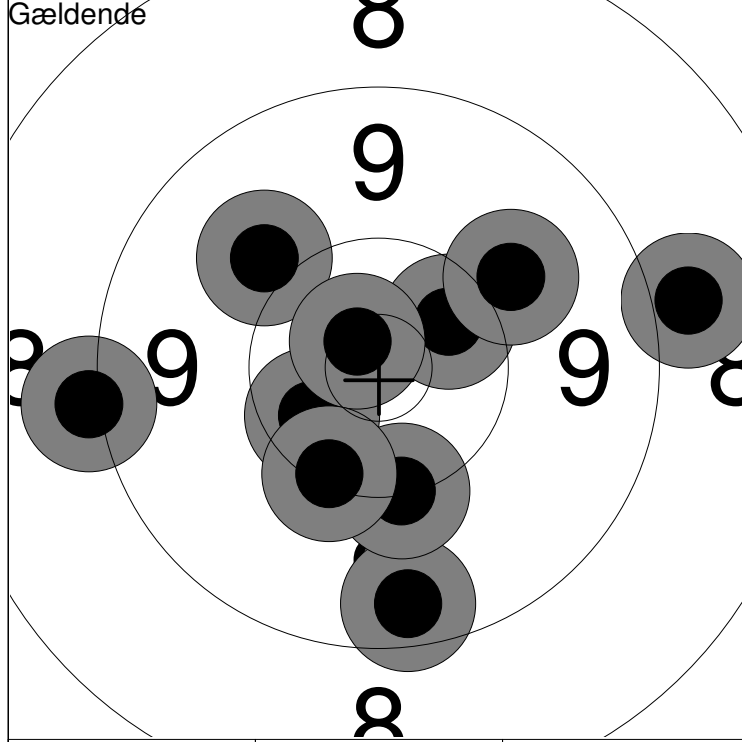

1: 10.0 ↖	6: 10.2 ↓	Serie	96
2: 9.1 ←	7: 10.0 ↗		
3: *10.4 ↘	8: *10.7 ↖	Total	96
4: *10.4 ↗	9: 10.2 ↓		
5: 9.5 ↓	10: 8.9 →		

11: 9.8 ↖	Serie	97
12: *10.6 ↘		
13: 10.2 ↖	Total	193
14: *10.5 ↘		
15: 9.4 ↗		

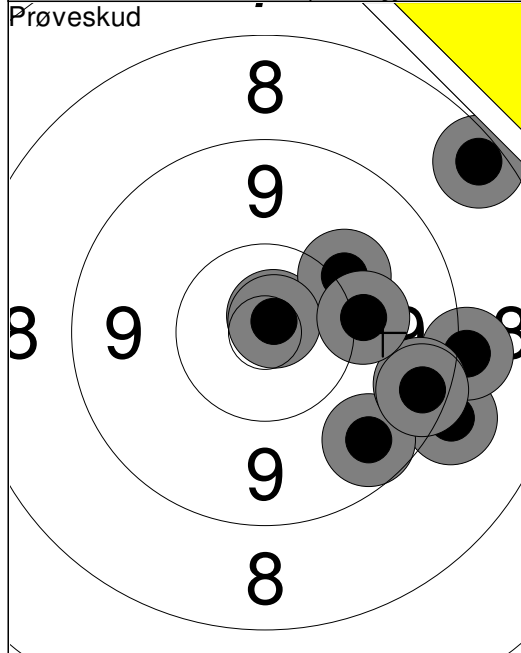

1:	*10.8 ↗
2:	9.1 →
3:	10.1 ↗
4:	9.6 ↓
5:	9.1 →
6:	9.5 →
7:	9.4 →
8:	8.4 ↗
9:	*10.8 ↗
10:	10.1 →
Serie	93.0
Total	0.0

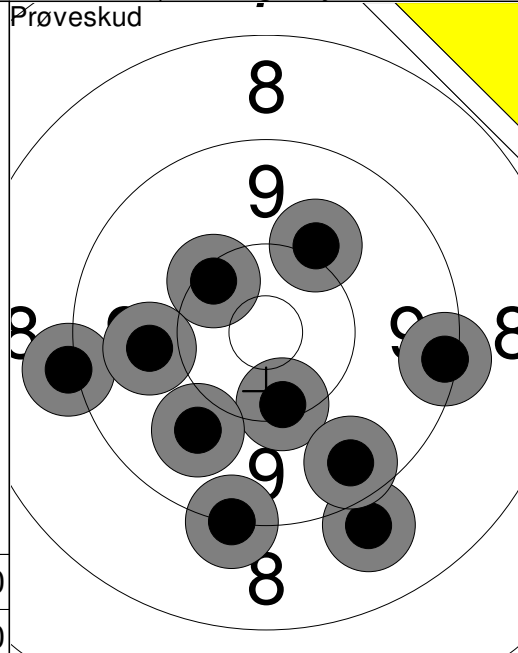

11:	10.1 ↗
12:	10.3 ↓
13:	9.1 ←
14:	8.9 ↓
15:	10.3 ↗
16:	9.2 ↓
17:	9.3 →
18:	9.5 ↓
19:	9.9 ↓
20:	9.9 ←
Serie	92.0
Total	0.0

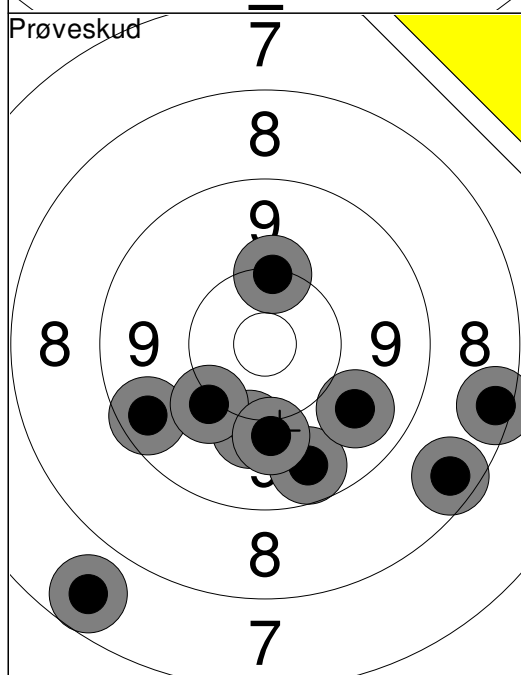

21:	8.4 →
22:	8.5 ↓
23:	9.6 ↓
24:	9.8 →
25:	10.1 ↓
26:	9.5 ←
27:	10.2 ↑
28:	7.6 ↓
29:	10.1 ↙
30:	10.0 ↓
Serie	90.0
Total	0.0

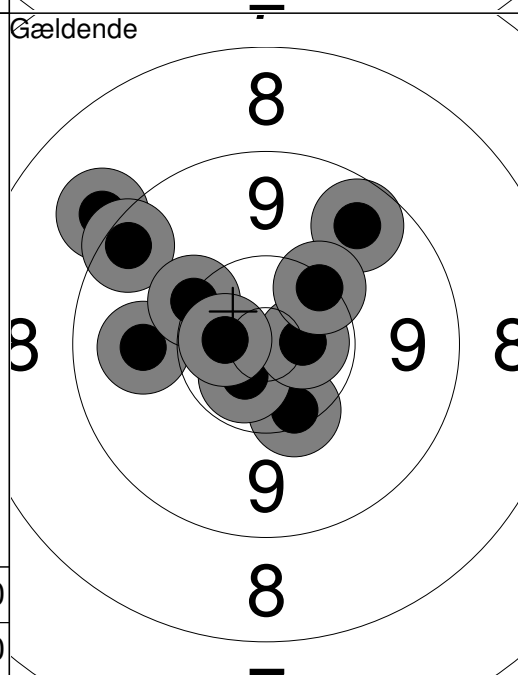

1:	9.0 ↖
2:	10.3 ↓
3:	9.9 ←
4:	9.6 ↗
5:	9.4 ↖
6:	10.2 ↖
7:	*10.6 ↙
8:	*10.6 →
9:	10.3 ↗
10:	*10.6 ↖
Serie	96.0
Total	96.0

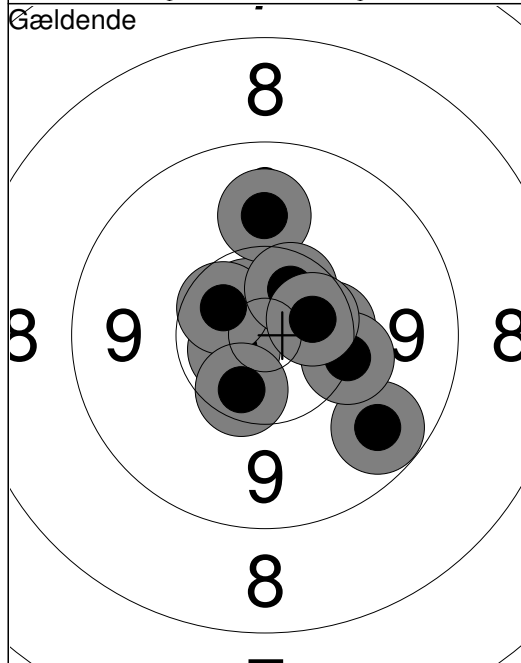

11:	*10.6 ↖
12:	*10.6 ↖
13:	*10.5 ↖
14:	10.4 →
15:	9.6 ↓
16:	10.2 →
17:	9.9 ↑
18:	*10.4 ↙
19:	*10.5 ↗
20:	*10.5 →
Serie	98.0
Total	194.0

Hold	Skive	Trine Herskind			
57	2				
50m	Vodskov Skytteforening	MB1			
	Nordjysk Mesterskab 2013	Aalborg Skyttekreds			
Prøveskud		1:	9.7	←	
		2:	10.1	←	
		3:	10.0	←	
		4:	10.1	↓	
		5:	10.2	↓	
		6:	10.4	←	
		7:	*10.6	←	
		8:	*10.8	↗	
		Serie		79.0	
		Total		0.0	
Gældende		1:	*10.5	↖	
		2:	9.9	←	
		3:	*10.6	↗	
		4:	*10.6	←	
		5:	*10.7	↘	
		6:	10.2	↗	
		7:	*10.6	↓	
		8:	10.3	→	
		9:	*10.6	→	
		10:	*10.5	←	
Serie		99.0			
Total		99.0			
Gældende		11:	9.8	↖	
		12:	*10.6	↓	
		13:	*10.6	←	
		14:	9.9	↘	
		15:	*10.7	↗	
		16:	*10.6	↓	
		17:	*10.6	→	
		18:	9.8	↘	
		19:	10.2	→	
		20:	10.1	↘	
Serie		97.0			
Total		196.0			

Hold 57	Skive 3	Magnus Larsen	
-------------------	-------------------	----------------------	--

50m	Vodskov Skytteforening	MB1	
-----	------------------------	-----	--

	Nordjysk Mesterskab 2013	Aalborg Skyttekreds	
--	--------------------------	---------------------	--

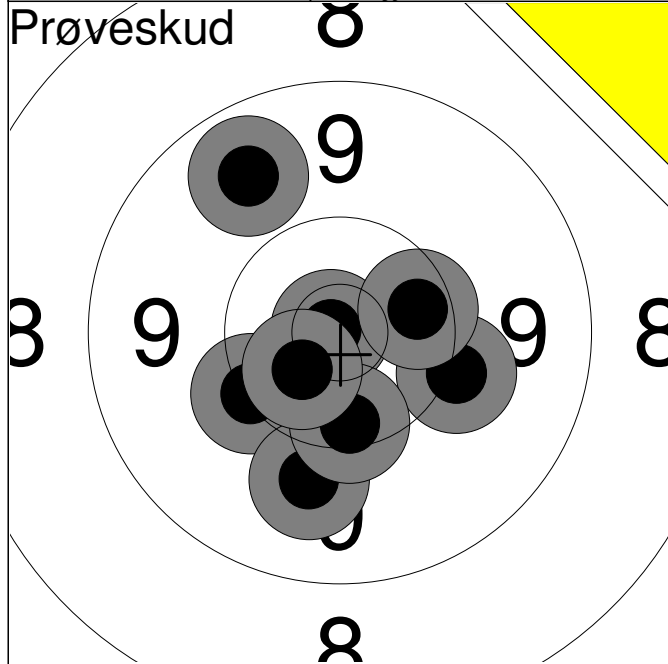

1:	10.2	↙
2:	9.7	↗
3:	10.1	↘
4:	*10.9	↖
5:	9.9	↘
6:	10.4	→
7:	10.3	↘
8:	*10.6	↙
Serie		78.0
Total		0.0

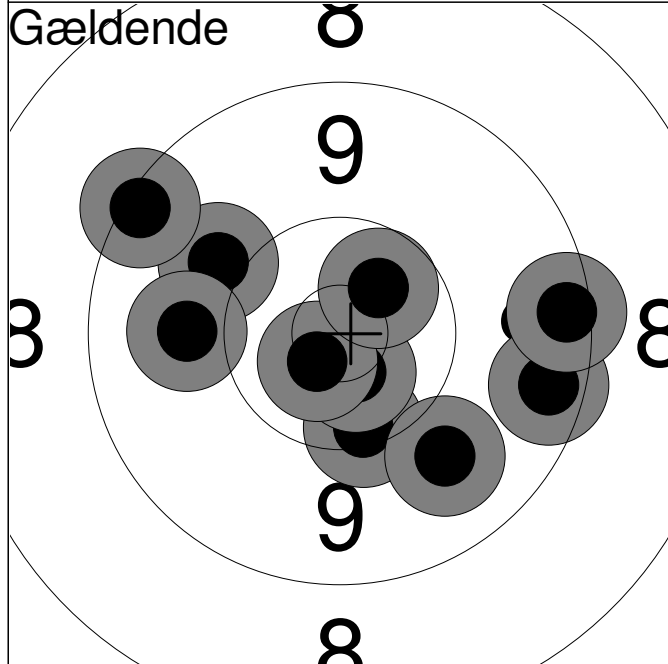

1:	9.4	→
2:	10.3	↘
3:	*10.7	↘
4:	9.8	↘
5:	9.3	→
6:	*10.7	↙
7:	10.0	↖
8:	*10.5	↖
9:	9.3	↖
10:	9.9	←
Serie		95.0
Total		95.0

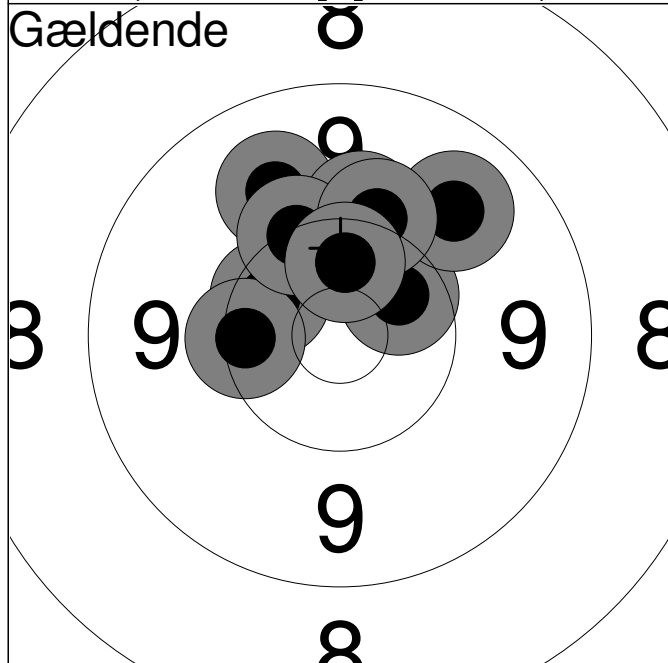

11:	10.2	↑
12:	*10.5	↗
13:	10.4	↖
14:	10.3	←
15:	9.9	↖
16:	10.1	↑
17:	9.8	↗
18:	10.2	↖
19:	10.1	↑
20:	*10.5	↑
Serie		98.0
Total		193.0

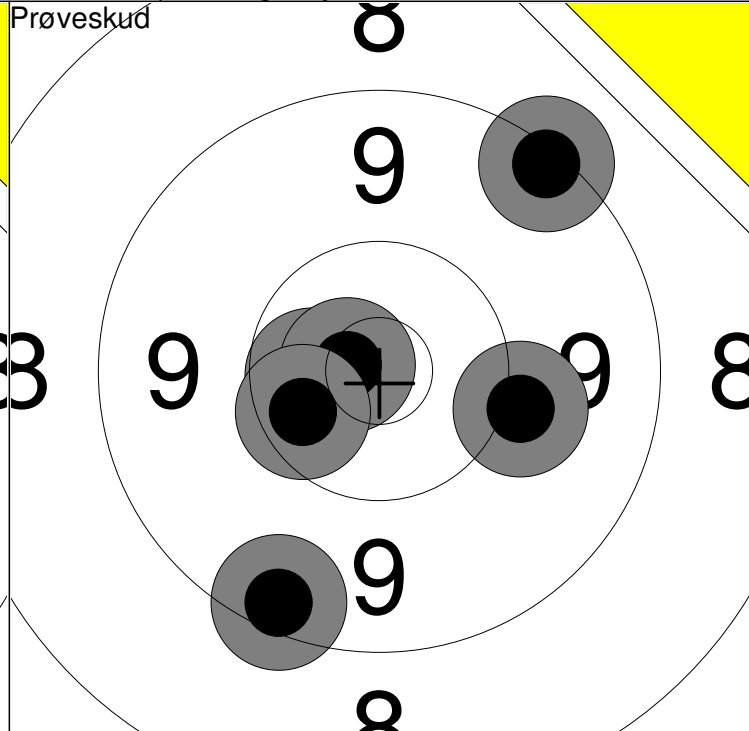
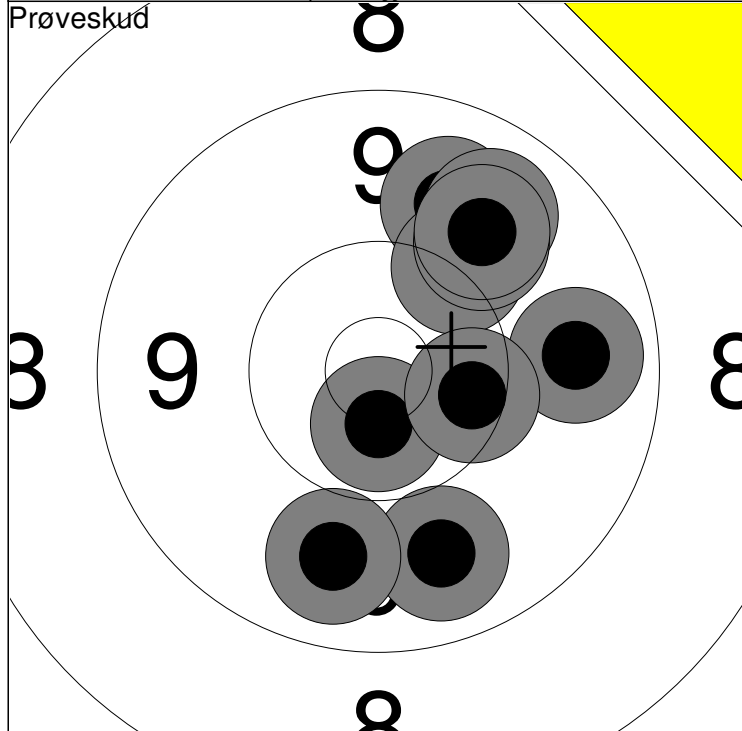

1: 9.8 ↗	6: 9.8 ↓	Serie 93
2: 9.8 ↗	7: *10.6 ↓	
3: 10.1 ↗	8: 9.8 ↓	Total 0
4: 9.9 ↗	9: 9.9 ↗	
5: 9.7 →	10: 10.4 →	

11: 9.3 ↗	16: *10.4 ↙	Serie 58
12: 10.1 →	13: *10.5 ↙	
14: *10.8 ↙	15: 9.4 ↓	Total 0

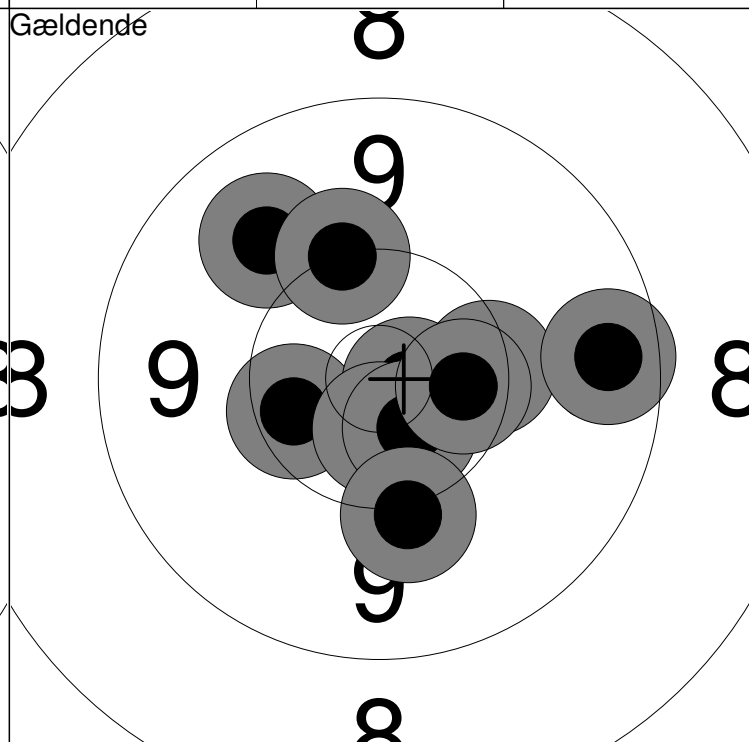
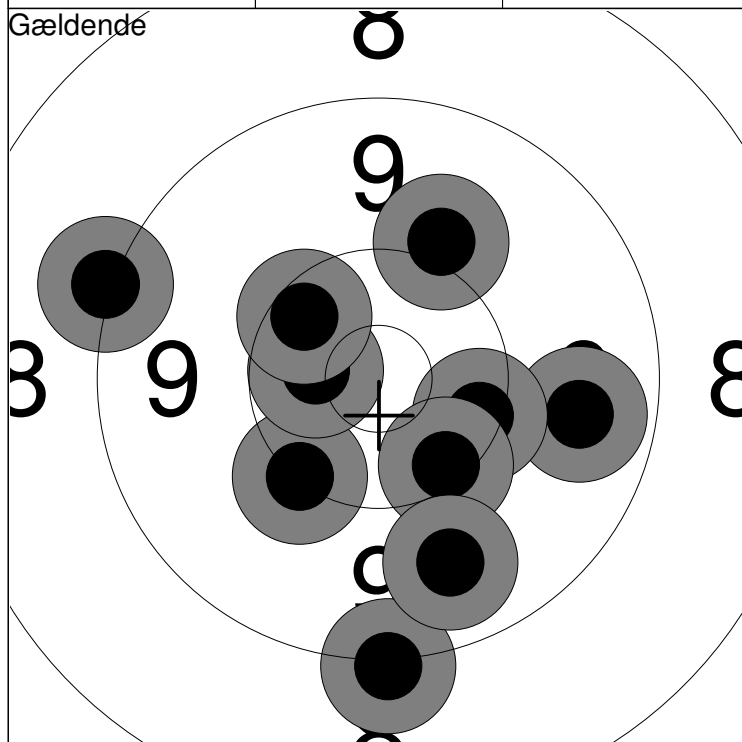

1: 9.1 ↓	6: 10.4 ↗	Serie 96
2: 9.1 ↙	7: 10.3 →	
3: 9.7 →	8: 10.3 ↓	Total 96
4: 10.2 ↙	9: 9.7 ↓	
5: *10.6 ↙	10: 10.0 ↗	

11: 9.9 ↗	16: 10.3 →	Serie 98
12: 10.4 ↙	17: 10.2 ↗	
13: *10.8 →	18: 10.1 ↓	Total 194
14: *10.6 ↓	19: *10.4 →	
15: *10.6 ↓	20: 9.5 →	

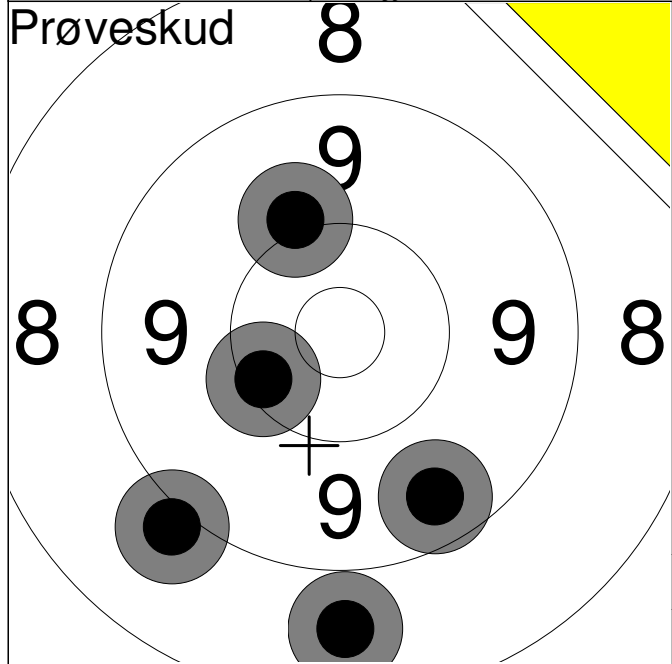

1:	9.5	↘
2:	9.0	↙
3:	8.7	↓
4:	10.1	↑
5:	10.3	↖
Serie		46.0
Total		0.0

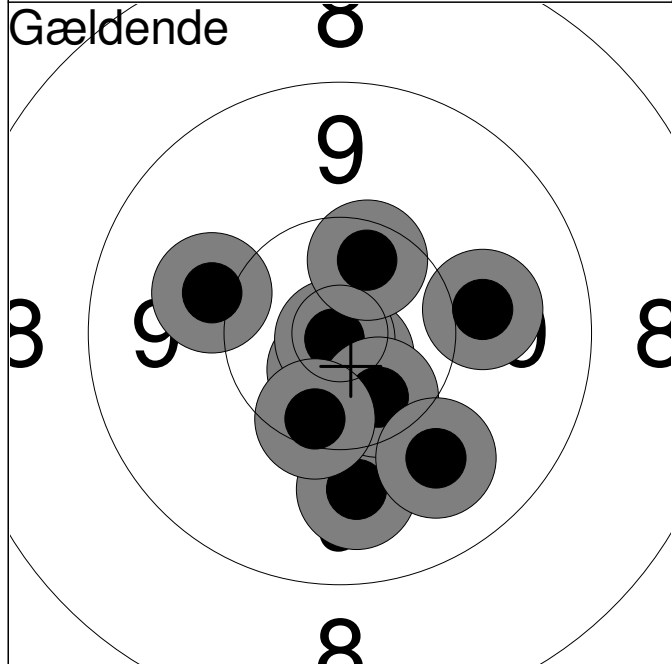

1:	10.0	↖
2:	*10.7	↘
3:	*10.8	↓
4:	*10.9	↙
5:	9.9	↓
6:	10.0	→
7:	*10.4	↘
8:	10.3	↘
9:	9.9	↘
10:	*10.4	↑
Serie		98.0
Total		98.0

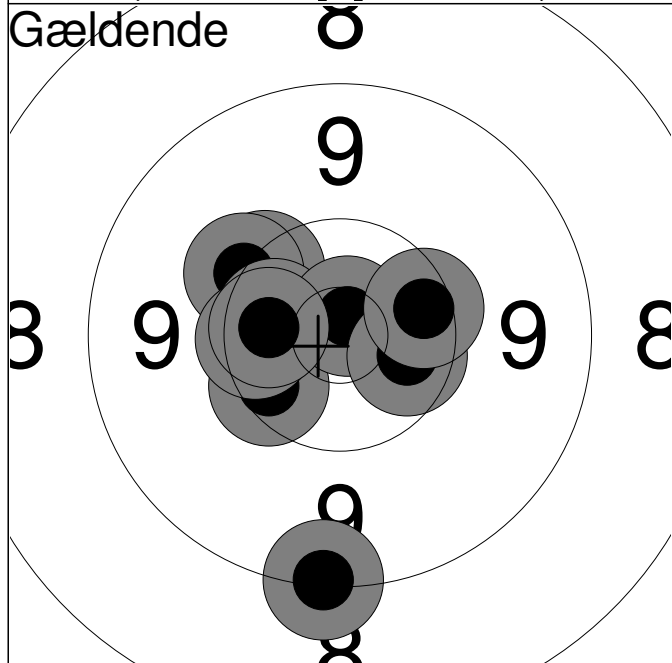

11:	10.3	↗
12:	10.2	↗
13:	*10.5	↖
14:	10.4	↙
15:	*10.8	↑
16:	9.2	↓
17:	*10.5	→
18:	10.4	←
19:	10.4	→
20:	*10.5	←
Serie		99.0
Total		197.0

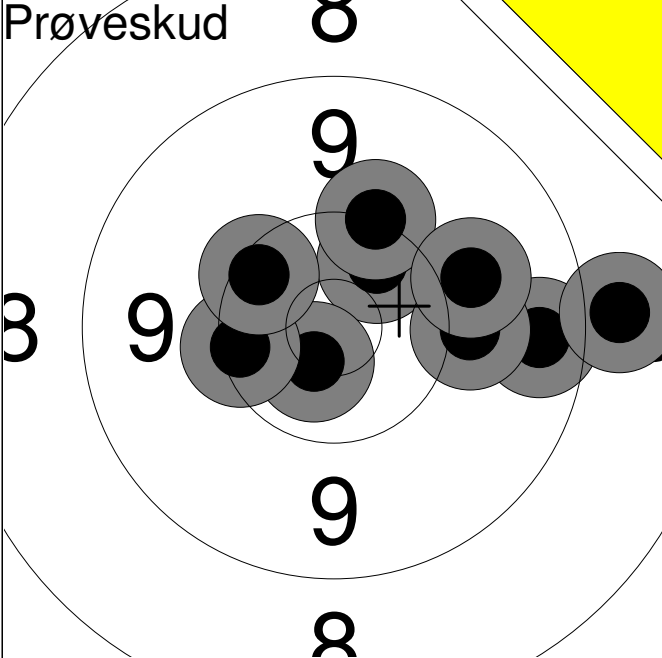
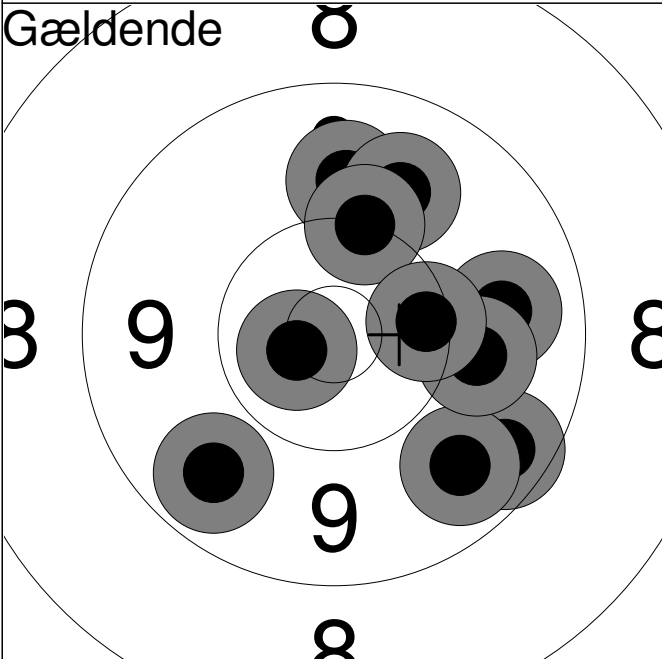
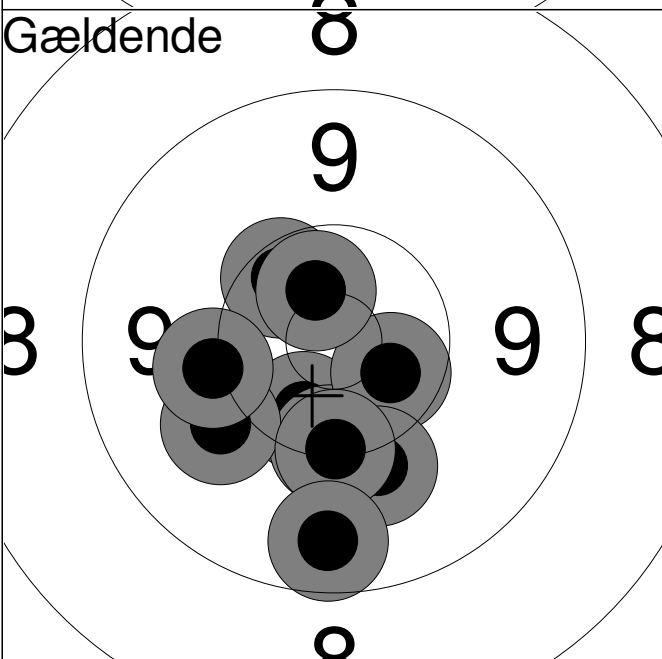
Hold	Skive	Tonny Nielsen	
57	6		
50m	Vodskov Skytteforening	MÅ2	
	Nordjysk Mesterskab 2013	Aalborg Skyttekreds	
Prøveskud 	1:	*10.4	↗
	2:	10.2	↑
	3:	9.5	→
	4:	*10.7	↘
	5:	8.9	→
	6:	10.0	→
	7:	10.0	→
	8:	10.3	←
	9:	10.3	↖
	Serie		87.0
Total		0.0	
Gældende 	1:	9.9	↑
	2:	9.8	→
	3:	9.9	↑
	4:	9.5	↘
	5:	10.2	↑
	6:	9.7	↘
	7:	9.7	↘
	8:	*10.7	←
	9:	10.0	→
	10:	10.3	→
Serie		94.0	
Total		94.0	
Gældende 	11:	*10.4	↘
	12:	10.2	↓
	13:	*10.5	↘
	14:	10.0	↘
	15:	10.4	↗
	16:	10.0	↘
	17:	*10.6	↗
	18:	10.1	←
	19:	10.2	↓
	20:	9.6	↓
Serie		99.0	
Total		193.0	

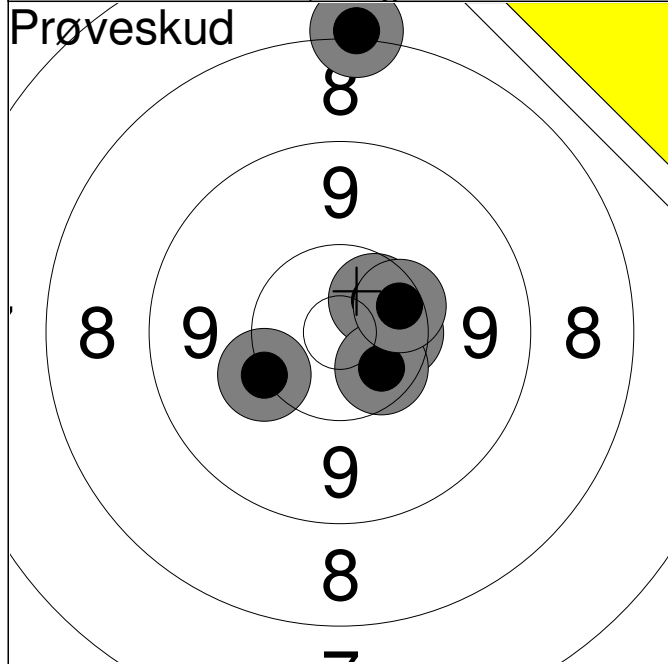

1:	*10.4	→
2:	*10.5	↗
3:	8.1	↑
4:	*10.5	↘
5:	10.4	↗
6:	10.2	↙

Serie	58.0
Total	0.0

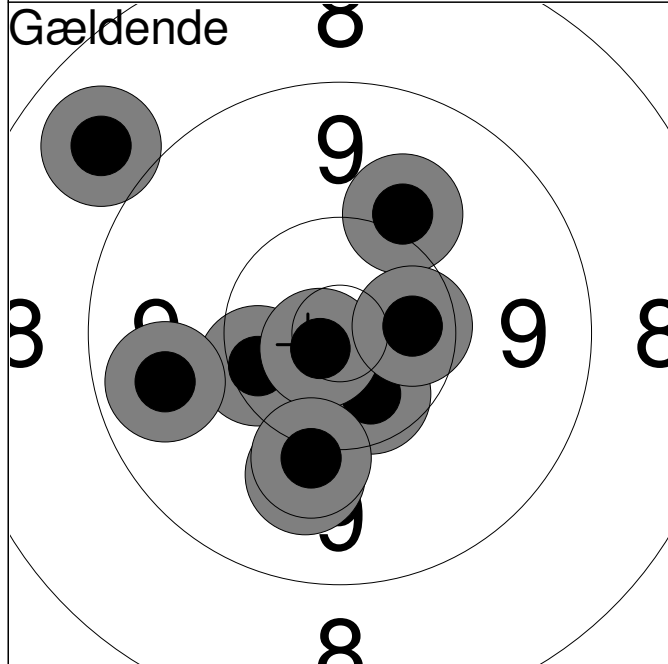

1:	10.4	↙
2:	9.7	↙
3:	8.8	↗
4:	10.0	↗
5:	*10.7	↓
6:	10.0	↓
7:	*10.5	↓
8:	*10.8	↙
9:	*10.5	→
10:	10.1	↓

Serie	97.0
Total	97.0

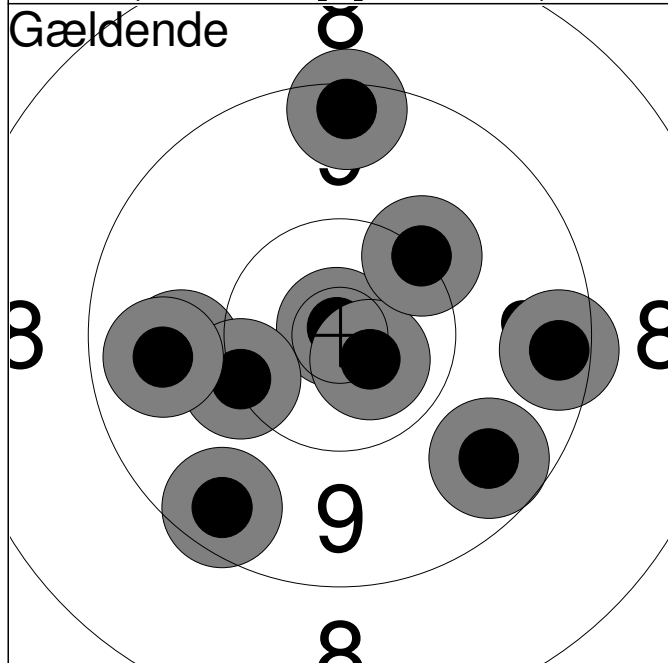

11:	*10.9	↖
12:	9.9	↙
13:	*10.7	↘
14:	10.2	↙
15:	9.7	↙
16:	9.4	→
17:	9.5	↙
18:	9.4	↑
19:	10.2	↗
20:	9.6	↘

Serie	94.0
Total	191.0

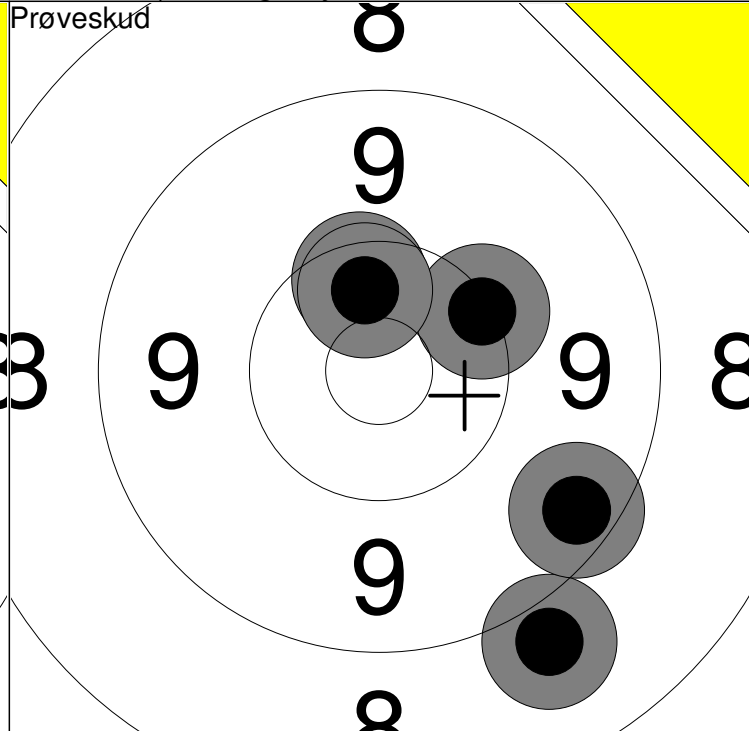
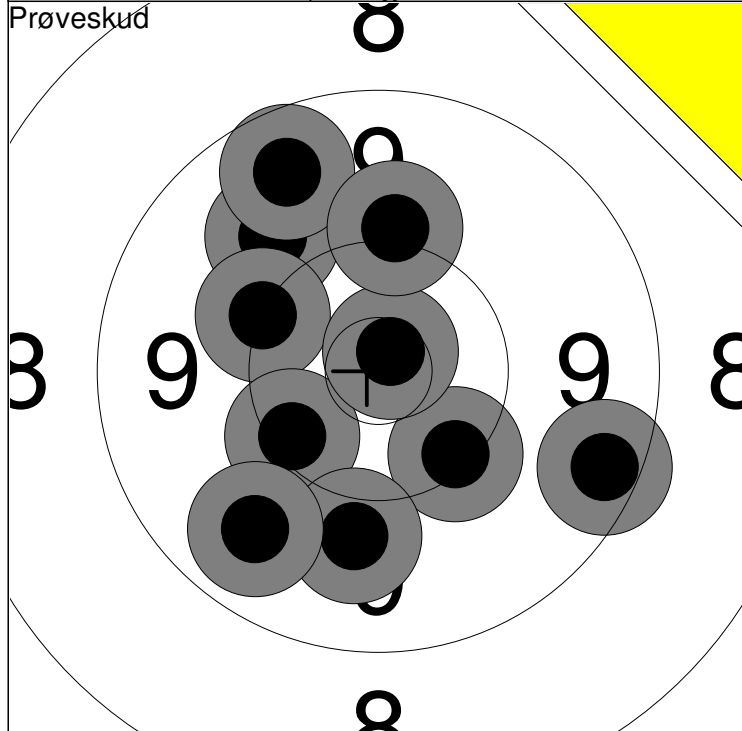

1: 9.9 ↗	6: 9.9 ↓	Serie	95
2: 10.2 ↖	7: *10.8 ↗		
3: 9.6 ↗	8: 9.7 ↓	Total	0
4: 10.3 ↖	9: 10.1 ↑		
5: 10.3 ↓	10: 9.4 →		

11: 8.9 ↓	Serie	47
12: 9.4 →		
13: 10.4 ↑	Total	0
14: 10.2 ↗		
15: *10.4 ↑		

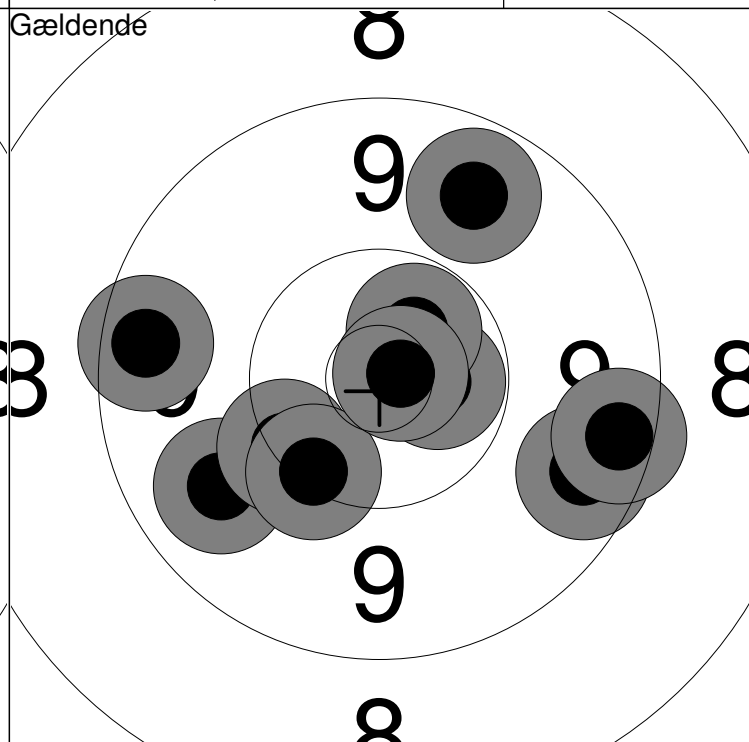
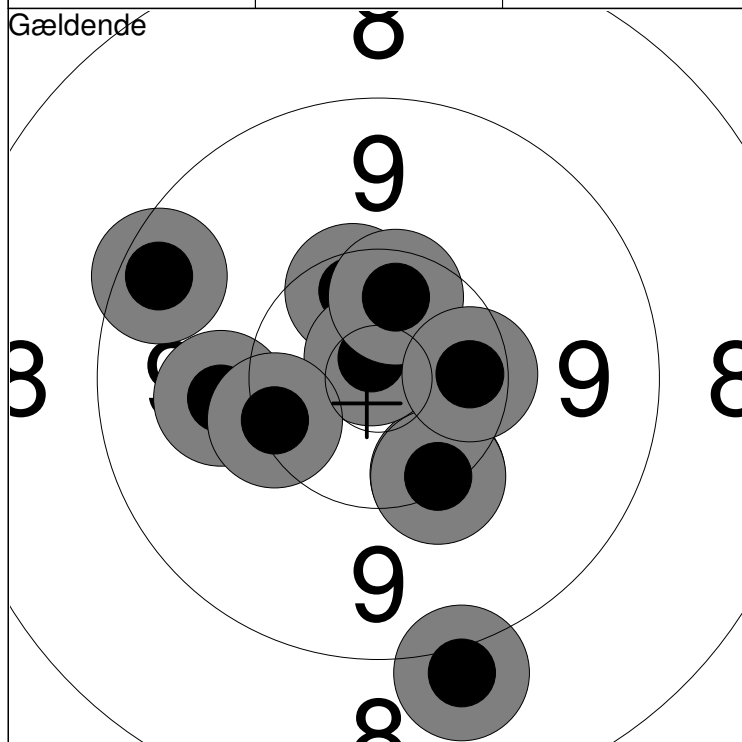

1: 9.4 ↖	6: 10.0 ←	Serie	98
2: 10.4 ↑	7: 9.0 ↓		
3: 10.3 ↓	8: 10.3 ↓	Total	98
4: *10.8 ↗	9: 10.3 ←		
5: *10.4 ↑	10: 10.4 →		

11: *10.6 →	16: 10.3 ↓	Serie	95
12: *10.6 ↗	17: 9.6 →		
13: 9.5 ←	18: 9.7 ↑	Total	193
14: 9.8 ↖	19: *10.8 →		
15: 10.2 ↖	20: 9.4 →		

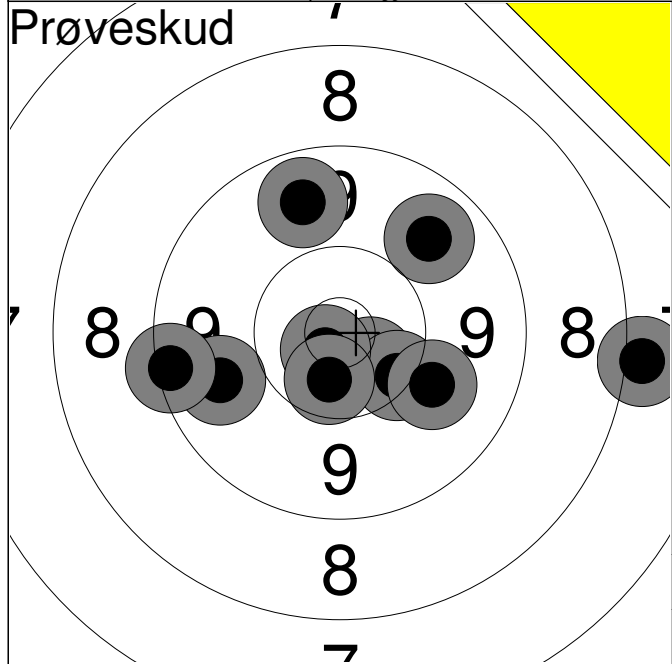

1:	*10.6	↘
2:	10.3	↘
3:	10.0	↘
4:	*10.7	↙
5:	9.8	←
6:	9.3	←
7:	9.7	↑
8:	*10.5	↘
9:	9.7	↗
10:	8.0	→
Serie		94.0
Total		0.0

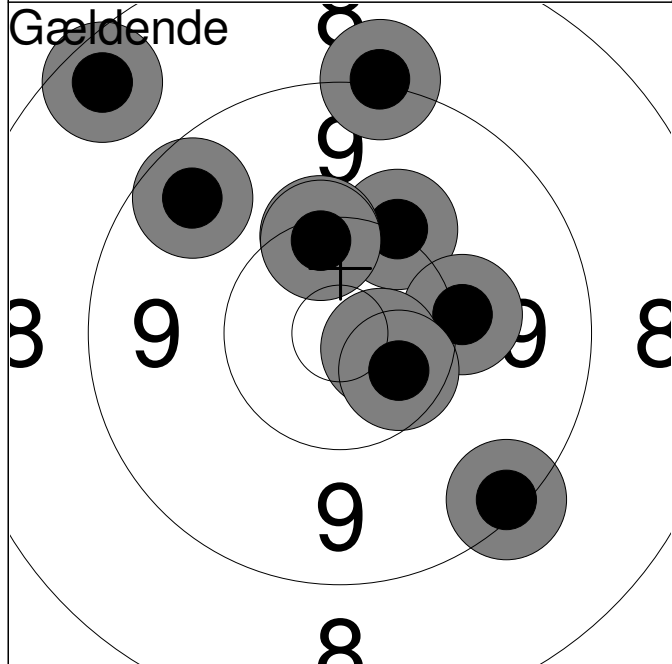

1:	10.1	↗
2:	9.3	↘
3:	9.6	↗
4:	10.1	→
5:	*10.7	→
6:	10.3	↑
7:	10.3	↑
8:	8.5	↗
9:	9.1	↑
10:	*10.5	↘
Serie		95.0
Total		95.0

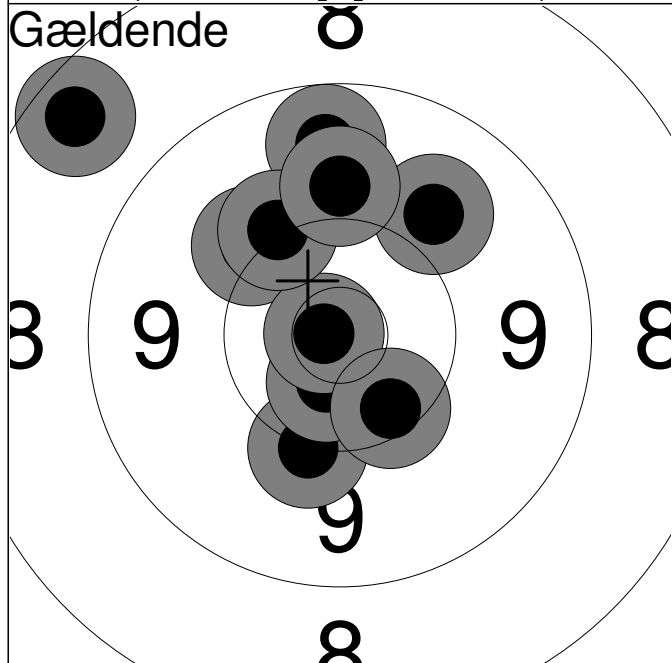

11:	10.1	↗
12:	9.9	↗
13:	8.5	↗
14:	9.6	↑
15:	10.2	↘
16:	*10.6	↘
17:	*10.8	←
18:	10.1	↗
19:	10.3	↘
20:	9.9	↑
Serie		95.0
Total		190.0

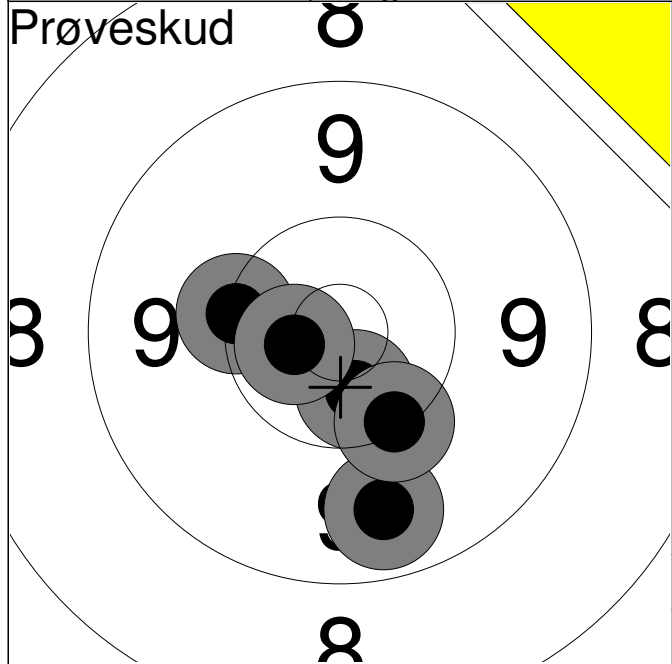

1:	9.7	↓
2:	*10.5	↓
3:	10.2	↓
4:	10.2	←
5:	*10.6	←
Serie		49.0
Total		0.0

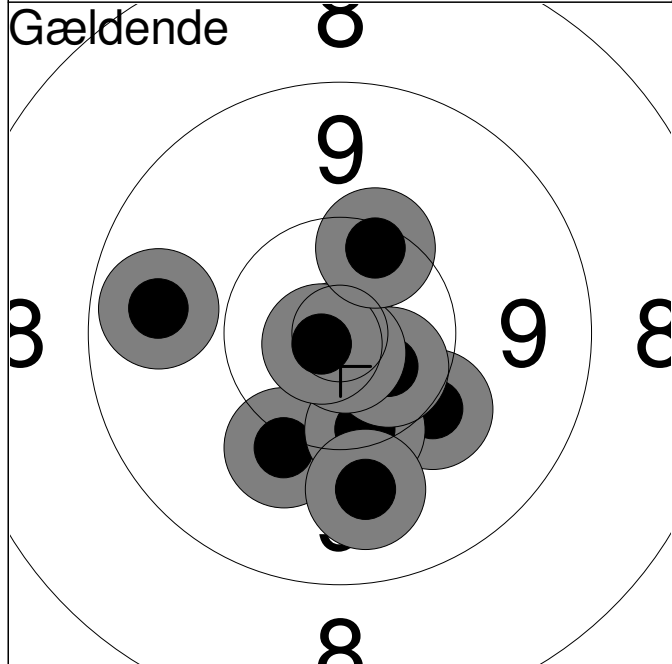

1:	9.7	←
2:	10.1	↓
3:	10.1	↓
4:	*10.9	↓
5:	10.3	↓
6:	*10.5	↓
7:	*10.8	↓
8:	*10.8	←
9:	9.9	↓
10:	10.3	↗
Serie		98.0
Total		98.0

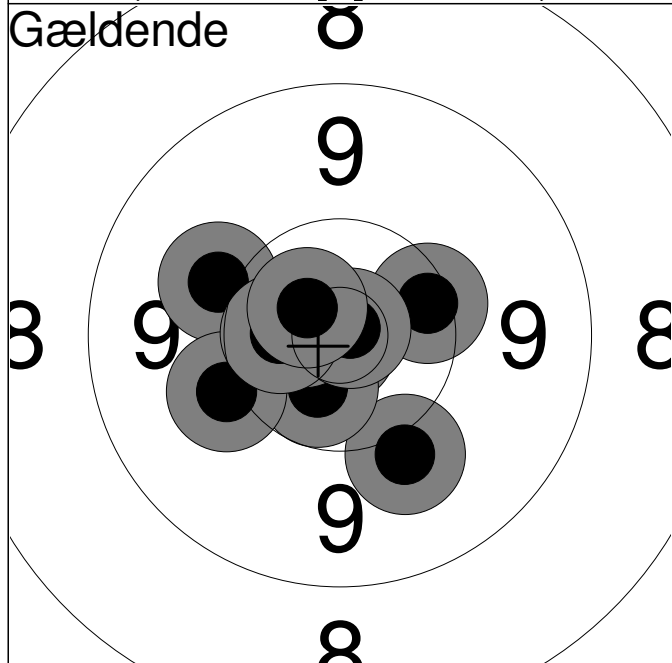

11:	10.3	→
12:	10.0	↓
13:	*10.9	↓
14:	*10.6	↓
15:	*10.7	←
16:	*10.9	↗
17:	10.0	↖
18:	10.1	←
19:	*10.5	←
20:	*10.7	↖
Serie		100.0
Total		198.0

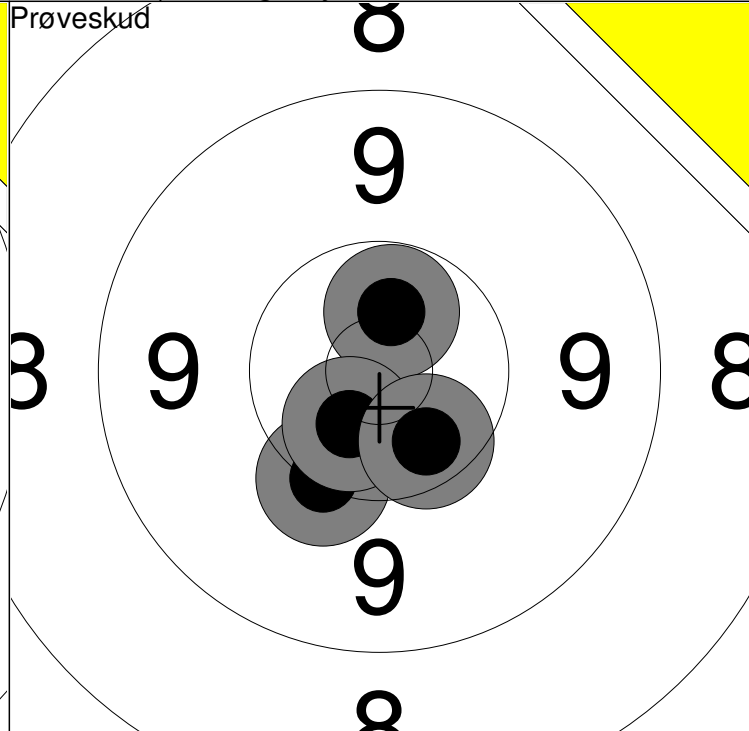
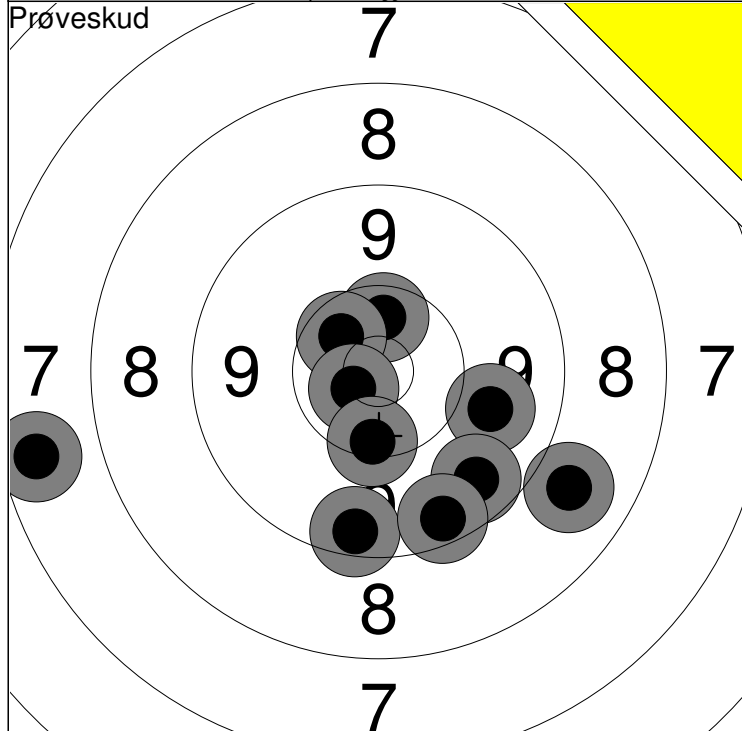

1: 7.5 ←	6: 9.9 →	Serie	91
2: *10.5 ↑	7: 10.3 ↓		
3: *10.5 ↖	8: 9.6 ↓	Total	0
4: 9.4 ↓	9: 8.8 ↓		
5: *10.7 ↙	10: 9.4 ↓		

11: *10.6 ↑	Serie	40
12: 10.2 ↓		
13: *10.6 ↓	Total	0
14: *10.4 ↓		

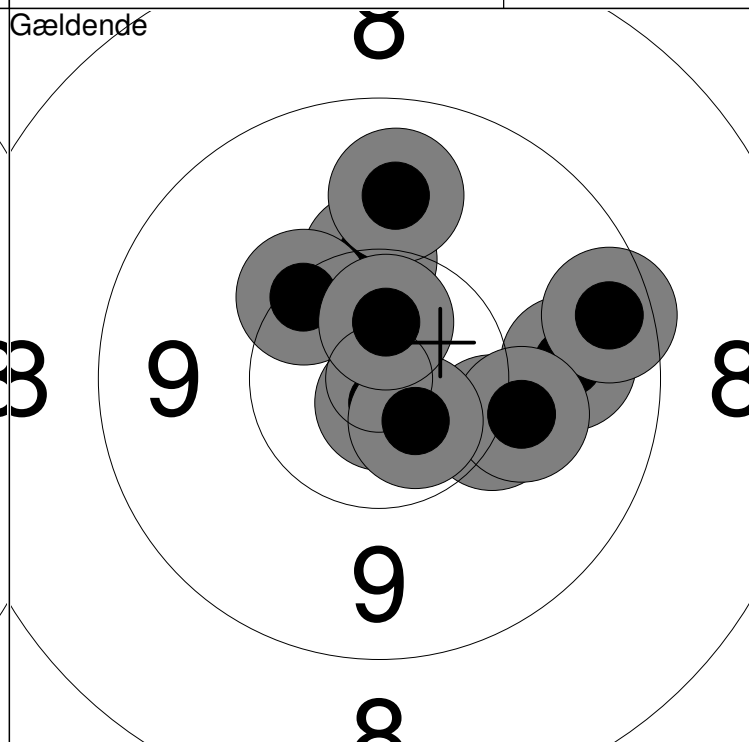
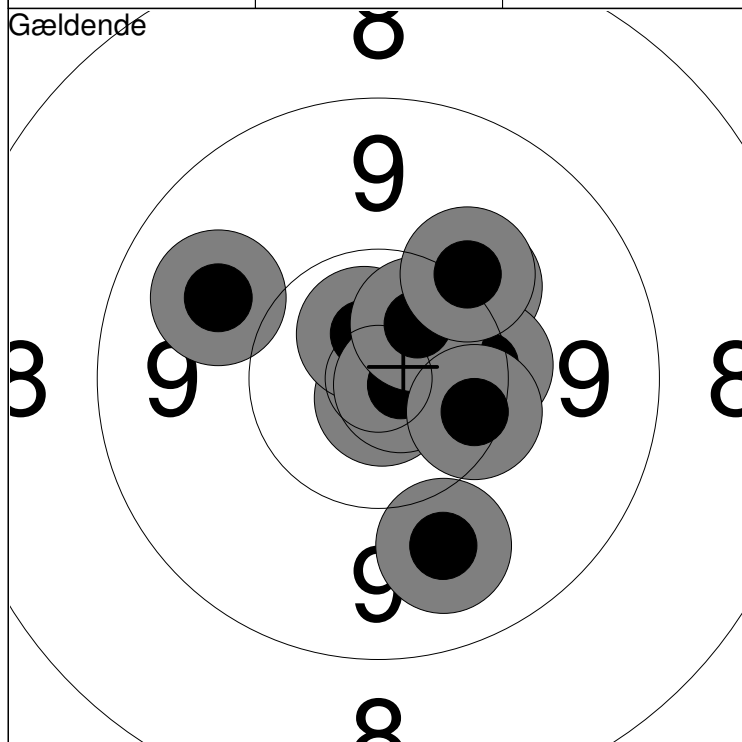

1: 9.8 ↖	6: 10.3 →	Serie	98
2: *10.8 ↓	7: *10.5 ↗		
3: *10.7 ↗	8: 9.8 ↓	Total	98
4: 10.1 ↗	9: 10.3 →		
5: *10.8 →	10: 10.1 ↗		

11: 9.8 →	16: *10.8 ↓	Serie	97
12: 10.2 →	17: *10.6 ↓		
13: 10.2 ↑	18: 9.8 ↑	Total	195
14: 9.5 →	19: 10.3 ↖		
15: 10.1 →	20: *10.6 ↑		

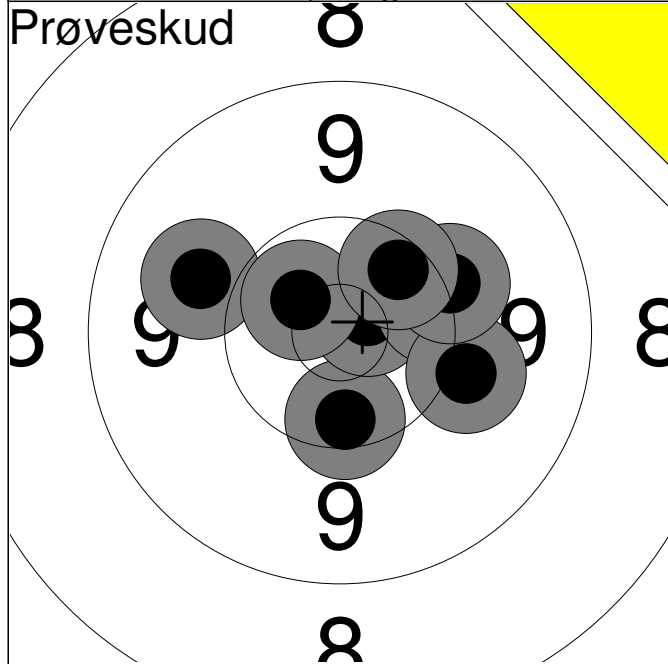

1:	10.4	↓
2:	*10.7	↗
3:	9.9	↖
4:	*10.6	↗
5:	10.3	→
6:	10.0	→
7:	10.1	↗
8:	10.4	↗
Serie		79.0
Total		0.0

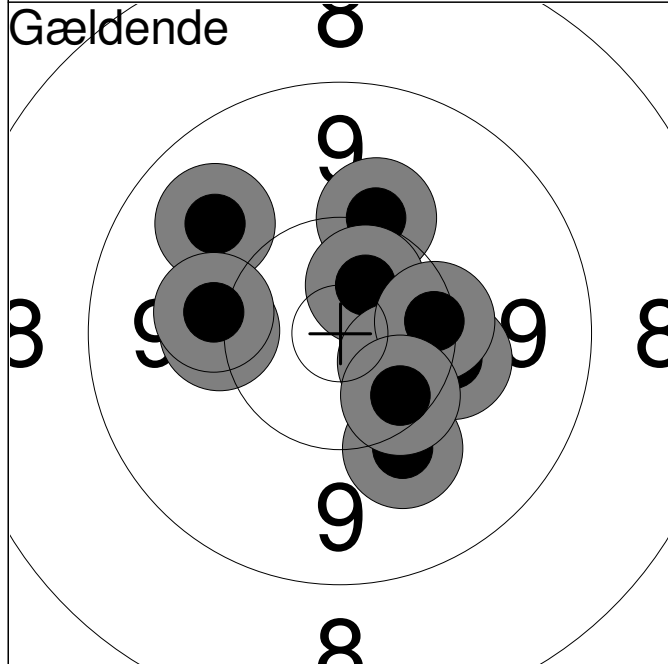

1:	9.8	↗
2:	10.1	←
3:	10.1	←
4:	10.1	↑
5:	*10.6	↗
6:	*10.5	↘
7:	10.1	↘
8:	10.2	→
9:	10.3	→
10:	10.4	↘
Serie		99.0
Total		99.0

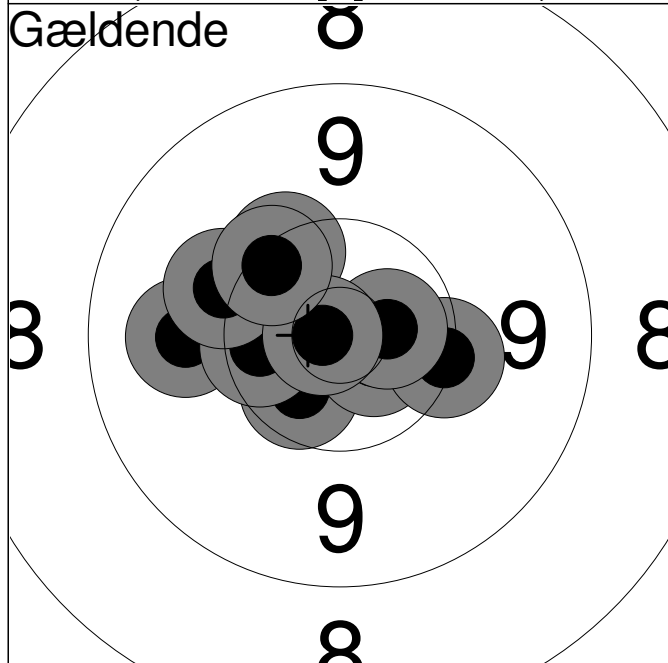

11:	*10.5	↙
12:	10.3	↗
13:	*10.7	↘
14:	9.9	←
15:	10.4	←
16:	10.1	↗
17:	10.2	→
18:	*10.6	→
19:	*10.8	←
20:	10.3	↗
Serie		99.0
Total		198.0

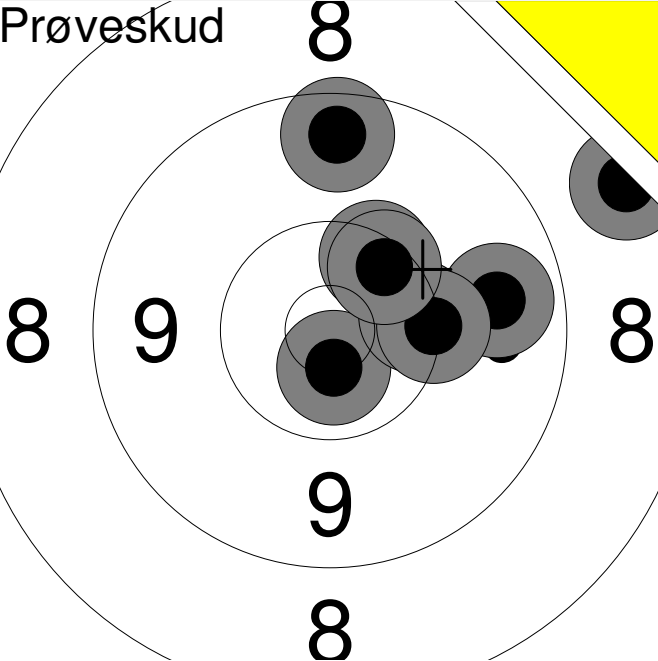
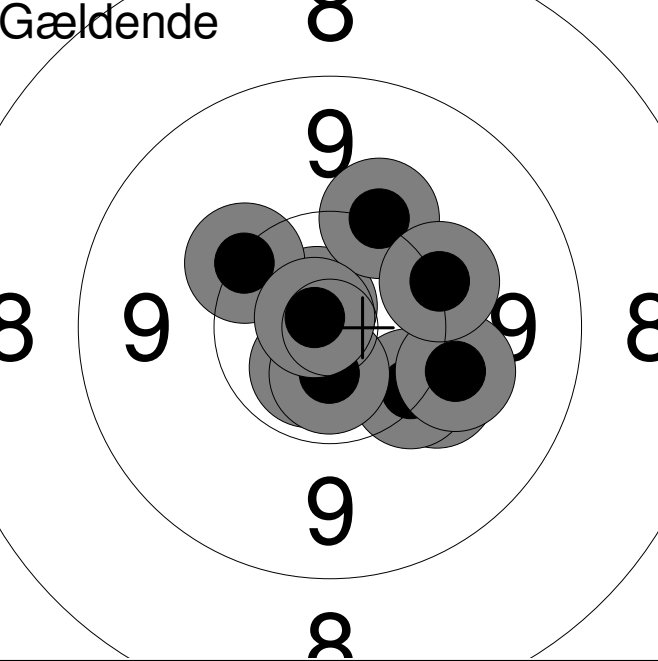
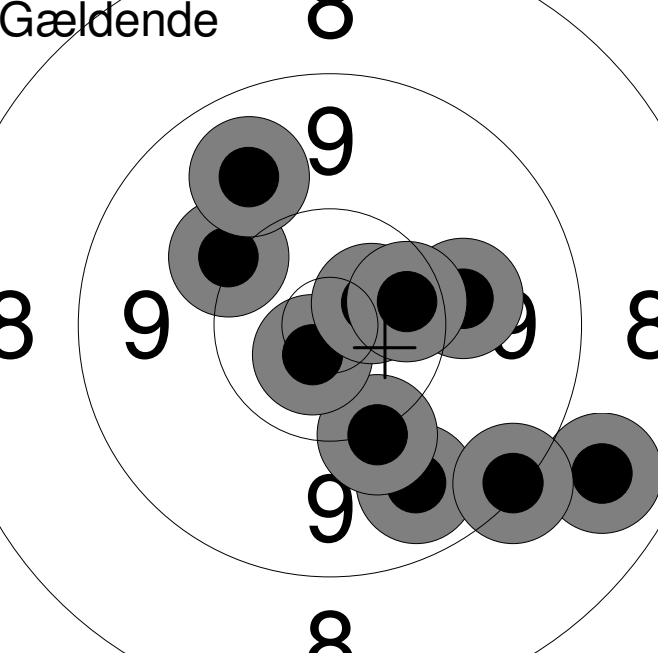
Hold	Skive	Louise Karstoft		
58	1	Vodskov Skytteforening	MB2	
50m		Nordjysk Mesterskab 2013	Aalborg Skyttekreds	
Prøveskud 	8	1:	8.4	↗
	8	2:	*10.7	↓
	9	3:	9.7	↗
	8	4:	9.5	↑
	9	5:	10.3	↗
	8	6:	10.2	↗
	9	7:	10.3	↗
	8	8:	10.3	↗
		Serie	76.0	
		Total	0.0	
Gældende 	8	1:	*10.6	↘
	9	2:	10.1	↘
	8	3:	10.3	↘
	9	4:	10.0	↘
	8	5:	*10.8	↗
	9	6:	10.1	↗
	9	7:	10.2	↗
	8	8:	*10.6	↘
	9	9:	10.1	↗
	8	10:	*10.8	↗
	Serie	100.0		
	Total	100.0		
Gældende 	8	11:	9.7	↘
	9	12:	8.7	↘
	8	13:	10.1	↘
	9	14:	*10.7	↘
	8	15:	10.1	↗
	9	16:	*10.6	↗
	9	17:	10.0	↗
	8	18:	10.4	↗
	9	19:	9.8	↗
	8	20:	9.2	↘
	Serie	95.0		
	Total	195.0		

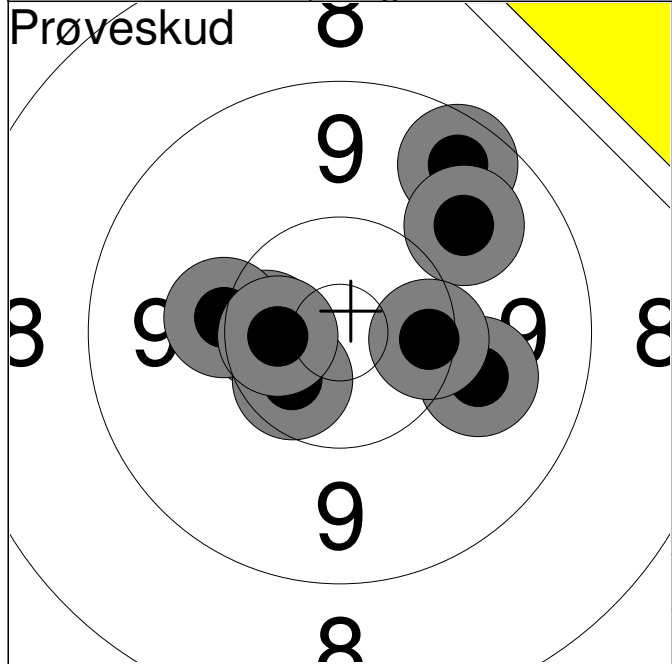

1:	9.5	↗
2:	9.8	↗
3:	10.0	→
4:	*10.4	←
5:	10.2	←
6:	*10.5	↙
7:	10.3	→
8:	*10.5	←
Serie		78.0
Total		0.0

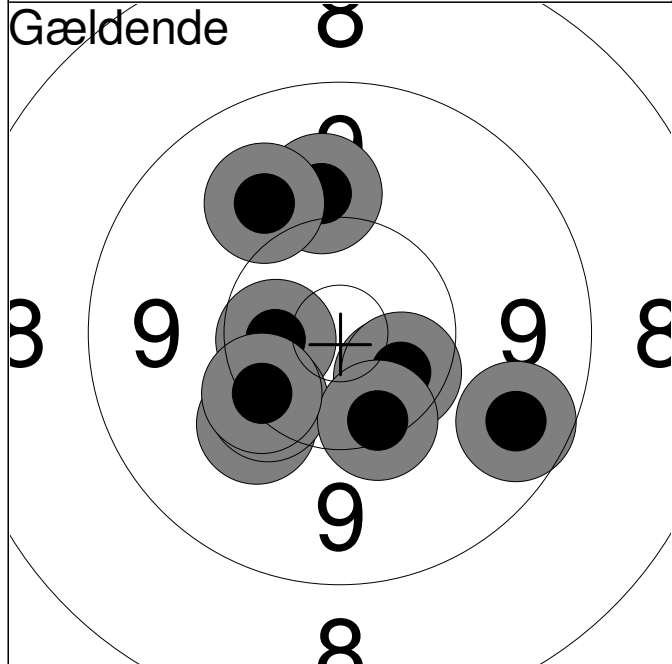

1:	*10.5	↘
2:	*10.5	↘
3:	10.0	↑
4:	*10.5	←
5:	10.1	↙
6:	9.6	↘
7:	10.3	↙
8:	9.9	↗
9:	10.3	↘
10:	10.3	↙
Serie		98.0
Total		98.0

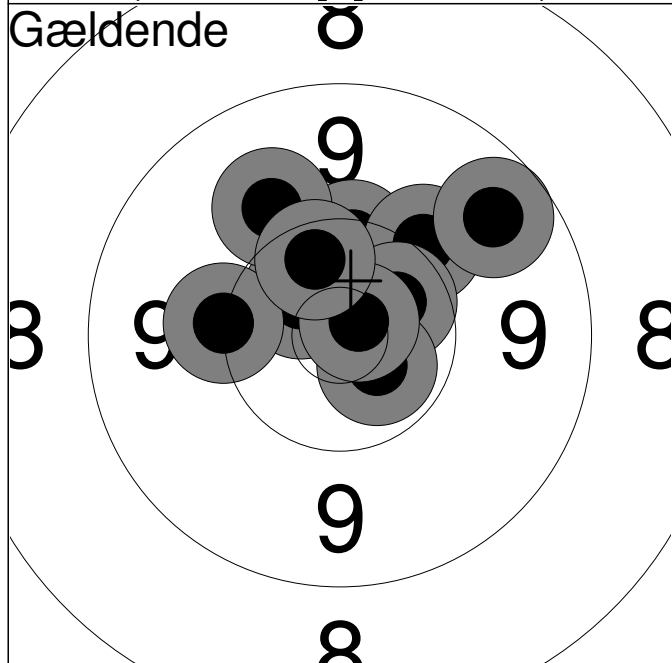

11:	10.3	↑
12:	*10.6	↖
13:	10.1	↗
14:	9.6	↗
15:	10.2	←
16:	*10.5	↗
17:	*10.6	↘
18:	*10.8	↗
19:	10.0	↗
20:	10.4	↗
Serie		99.0
Total		197.0

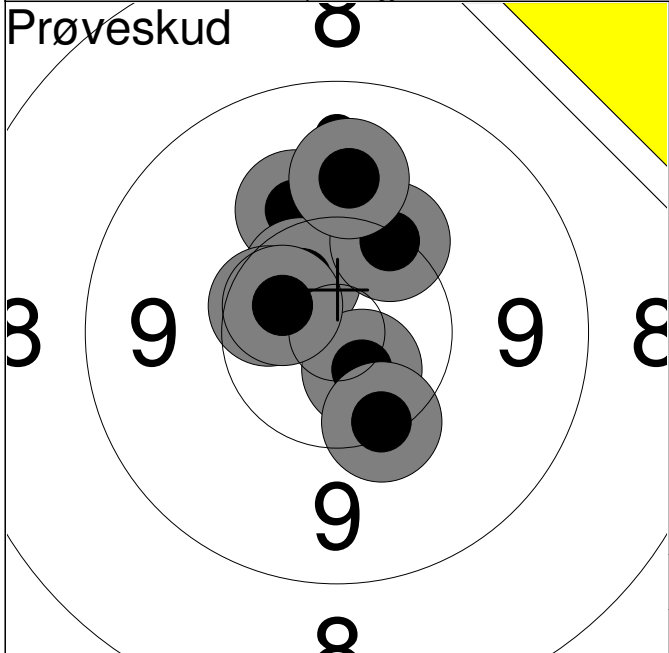
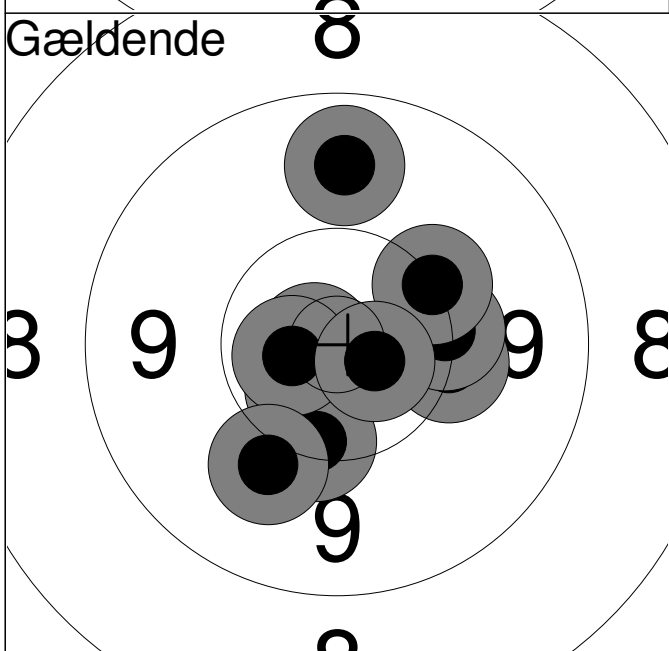
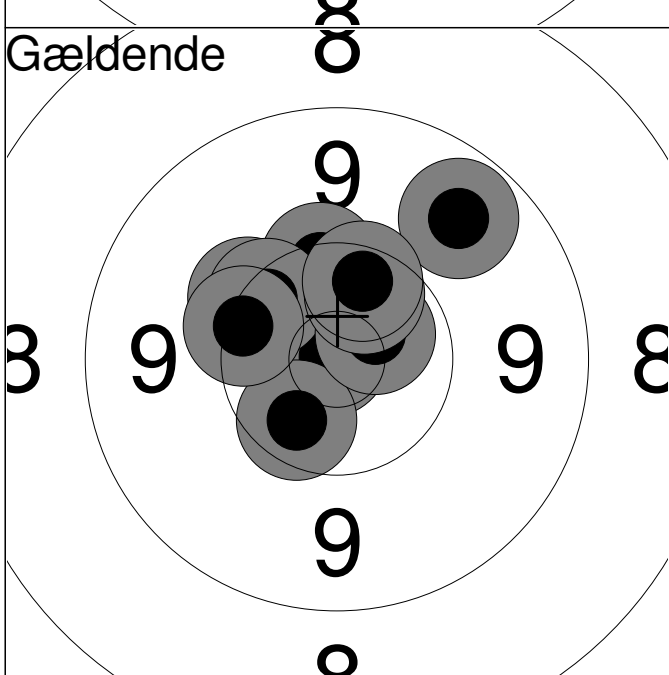
	Nordjysk Mesterskab 2013	Aalborg Skyttekreds	
Prøveskud 	8	1: 10.1	↑
	9	2: *10.5	↗
	8	3: *10.4	↖
	9	4: 10.2	↗
	8	5: 9.9	↑
	9	6: *10.6	↘
	8	7: 10.3	↘
	9	8: *10.5	↗
	8	Serie	79.0
9	Total	0.0	
Gældende 	8	1: 10.2	→
	9	2: *10.6	↘
	8	3: 10.2	→
	9	4: 10.3	↘
	8	5: *10.8	←
	9	6: *10.6	←
	8	7: 10.2	↗
	9	8: 9.7	↑
	8	9: 10.0	↘
	9	10: *10.7	→
8	Serie	99.0	
9	Total	99.0	
Gældende 	8	11: 10.3	↑
	9	12: 10.2	↗
	8	13: *10.9	↖
	9	14: *10.4	↘
	8	15: 10.3	↗
	9	16: 9.7	↗
	8	17: 10.3	↖
	9	18: *10.6	↗
	8	19: *10.5	↑
	9	20: 10.4	↑
	8	Serie	99.0
9	Total	198.0	

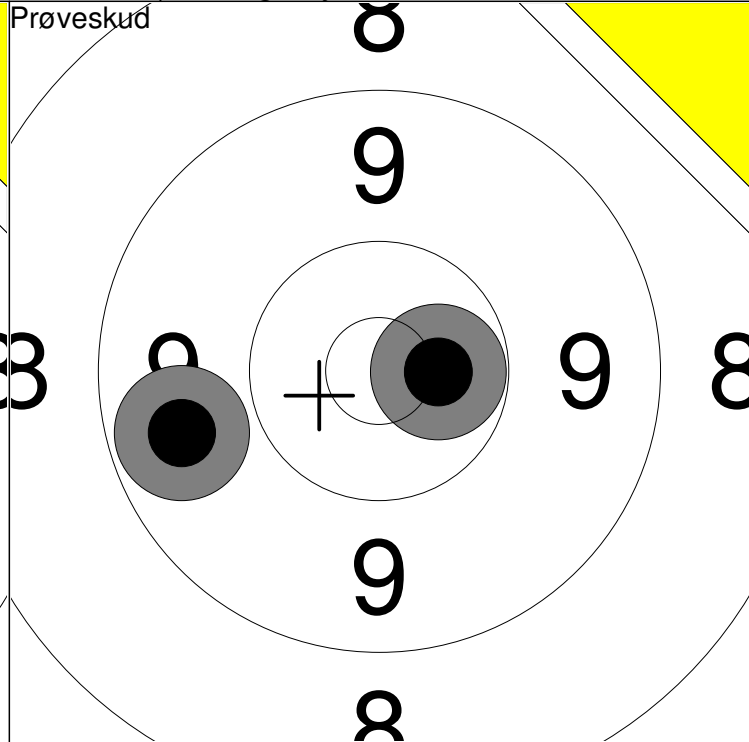
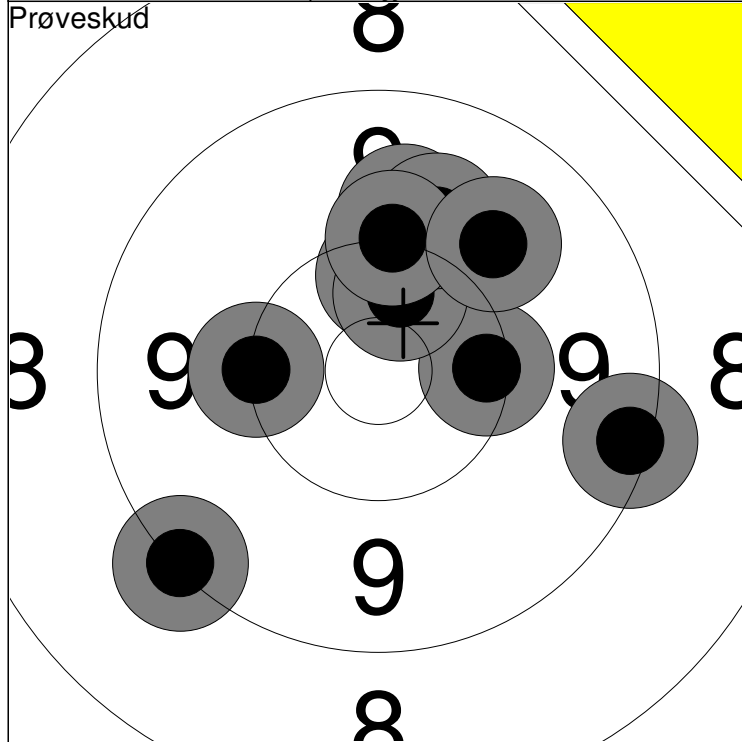

1: 10.3 →	6: 10.0 ↗	Serie	97
2: 10.4 ↑	7: 10.1 ↑		
3: 10.0 ↑	8: 10.2 ←	Total	0
4: *10.5 ↑	9: 9.9 ↗		
5: 9.2 ↘	10: 9.3 →		

11: 9.7 ←	Serie	19
12: *10.6 →		
	Total	0

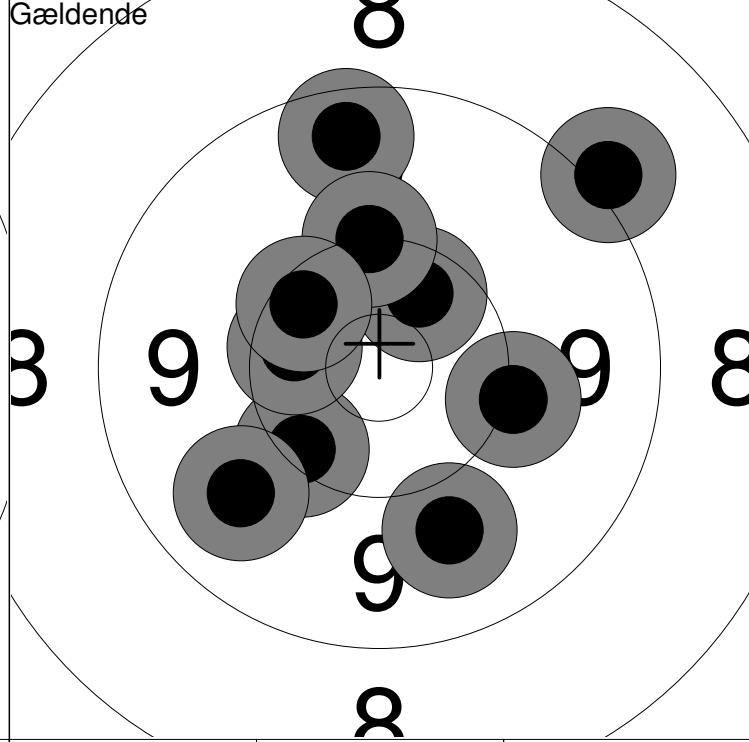
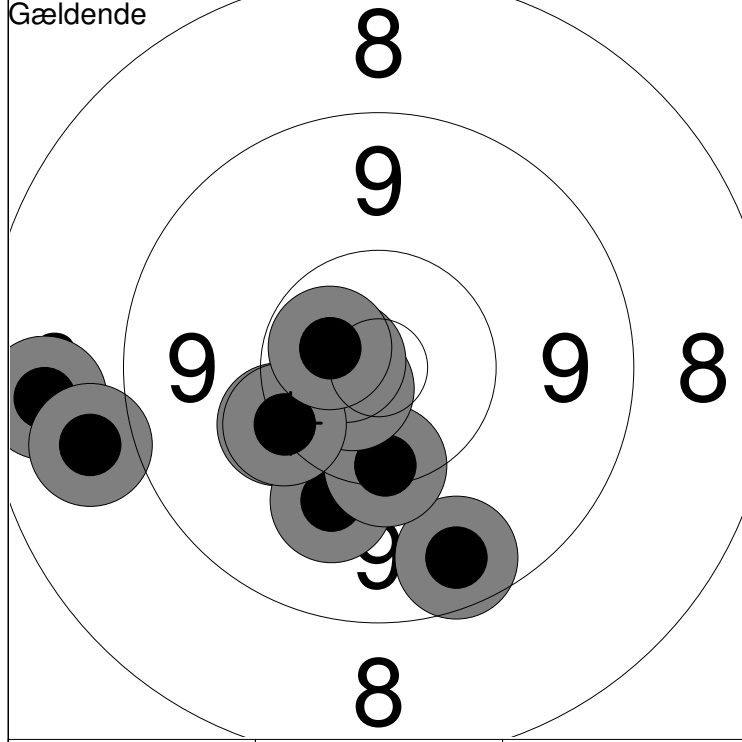

1: 9.5 ↓	6: 8.9 ←	Serie	95
2: 8.6 ←	7: *10.7 ↘		
3: 10.2 ↘	8: *10.7 ↘	Total	95
4: 10.0 ↓	9: 10.2 ↘		
5: 10.3 ↓	10: *10.6 ↘		

11: 9.1 ↗	16: 9.8 ↘	Serie	96
12: 10.1 →	17: 9.5 ↑		
13: *10.4 ↗	18: 9.9 ↓	Total	191
14: 10.3 ↘	19: 10.2 ↑		
15: *10.4 ↘	20: 10.3 ↘		

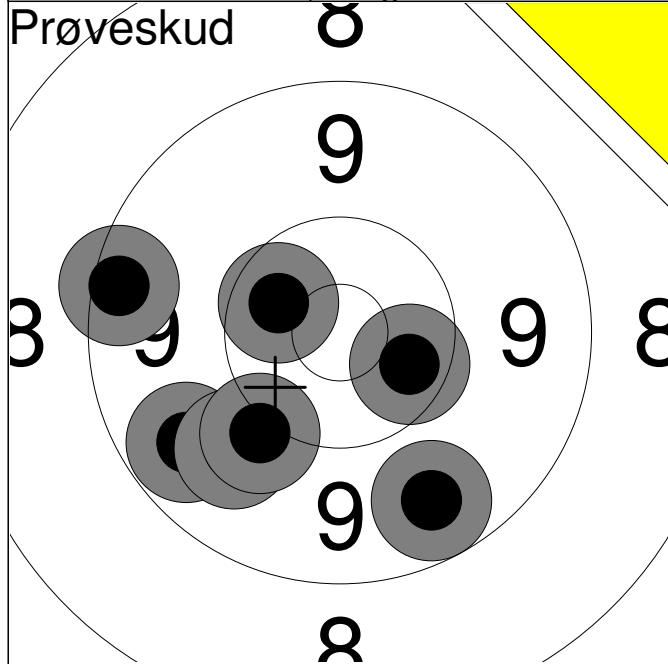

1:	*10.4	→
2:	9.4	←
3:	9.6	↙
4:	9.9	↘
5:	10.1	↘
6:	*10.5	↗
7:	9.6	↘
Serie		66.0
Total		0.0

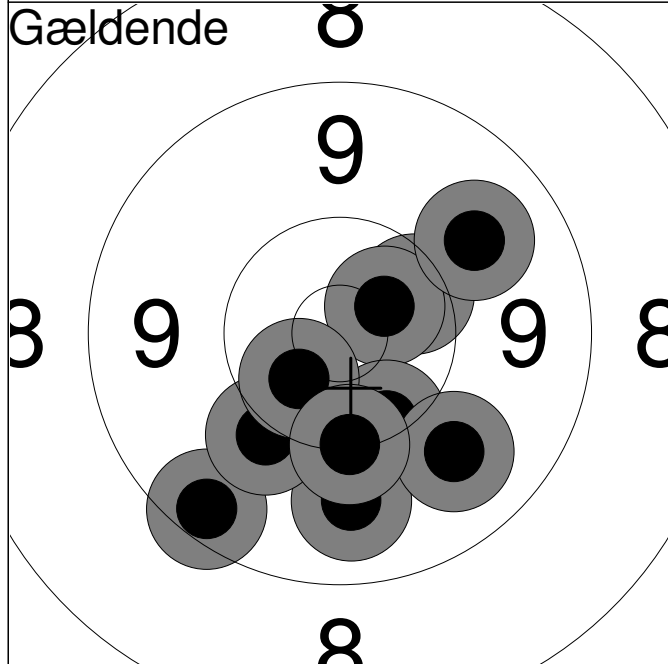

1:	10.4	↗
2:	*10.6	↗
3:	9.4	↙
4:	10.3	↘
5:	9.8	↗
6:	9.8	↓
7:	9.8	↘
8:	10.1	↙
9:	*10.5	↙
10:	10.2	↓
Serie		96.0
Total		96.0

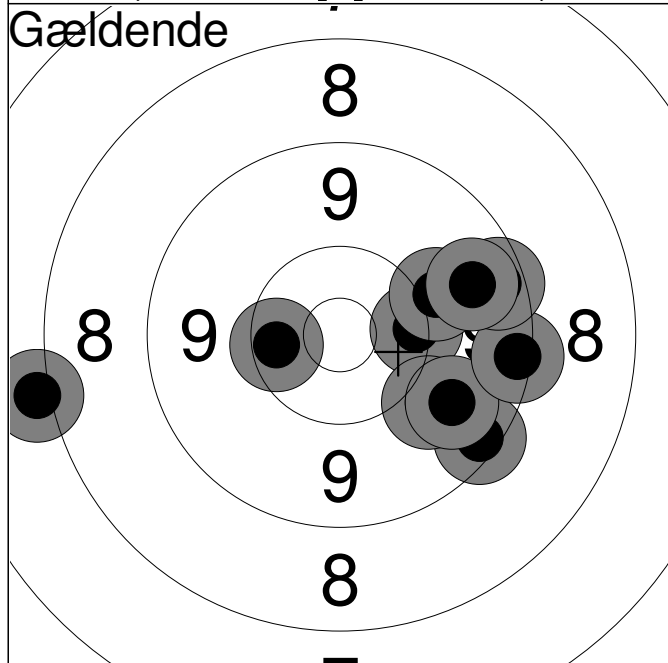

11:	10.3	→
12:	9.4	↘
13:	10.0	↘
14:	9.8	↘
15:	9.3	→
16:	8.1	←
17:	10.0	↗
18:	9.4	↗
19:	9.7	↗
20:	10.4	←
Serie		93.0
Total		189.0

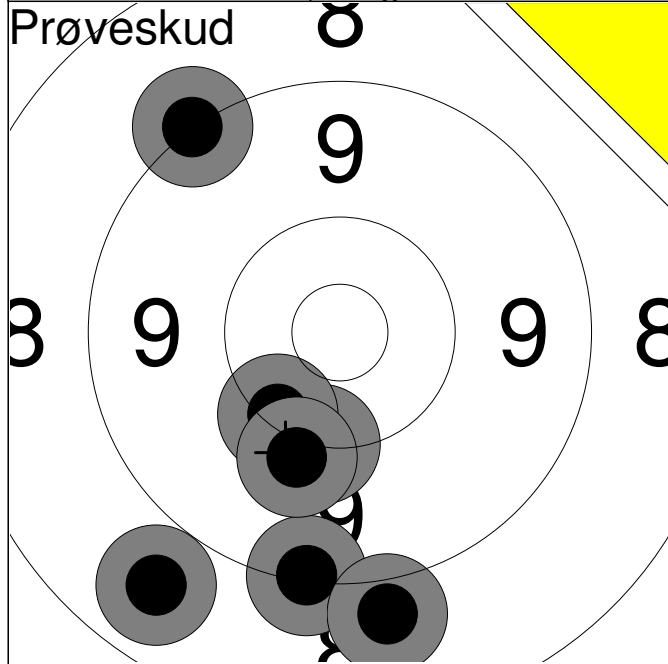

1:	9.2	↗
2:	8.7	↘
3:	10.2	↓
4:	10.2	↘
5:	9.2	↓
6:	8.9	↓
7:	10.0	↘
Serie		64.0
Total		0.0

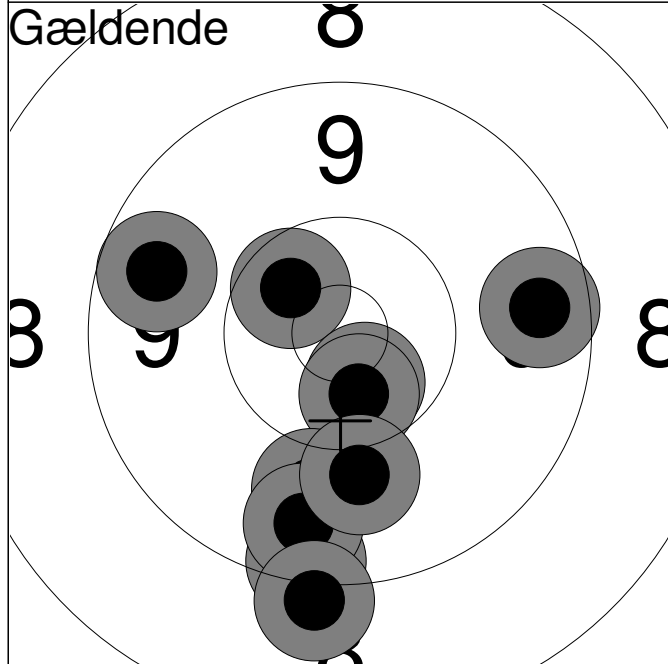

1:	9.3	↓
2:	*10.5	↗
3:	*10.6	↓
4:	*10.5	↓
5:	9.6	↗
6:	9.5	→
7:	9.9	↓
8:	9.6	↓
9:	10.0	↓
10:	9.1	↓
Serie		94.0
Total		94.0

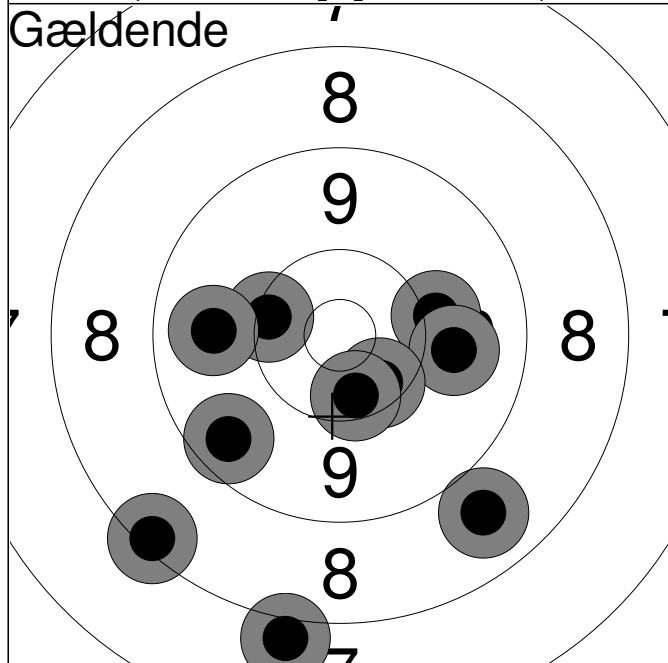

11:	10.3	←
12:	8.3	↘
13:	10.1	→
14:	9.8	←
15:	8.0	↓
16:	9.9	→
17:	10.4	↘
18:	8.8	↘
19:	10.4	↓
20:	9.5	↘
Serie		91.0
Total		185.0

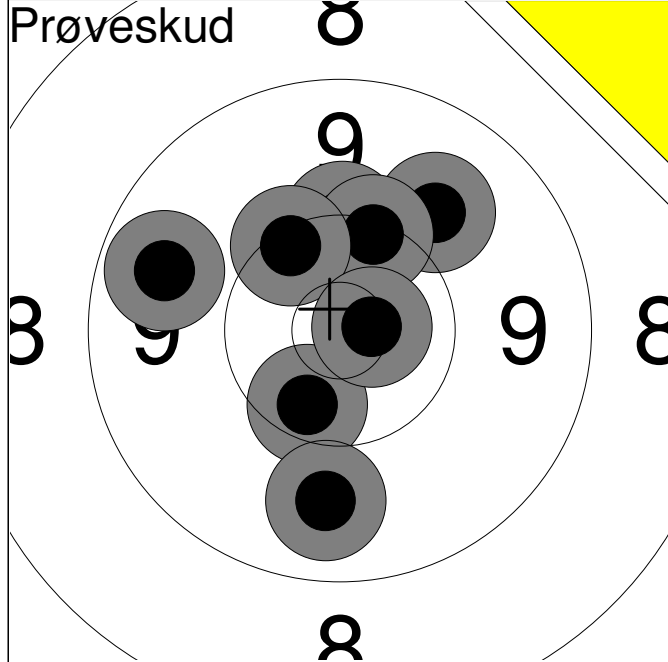

1:	9.9	↗
2:	10.2	↑
3:	9.7	↖
4:	10.4	↘
5:	10.3	↑
6:	10.3	↗
7:	9.8	↘
8:	*10.7	→
Serie		77.0
Total		0.0

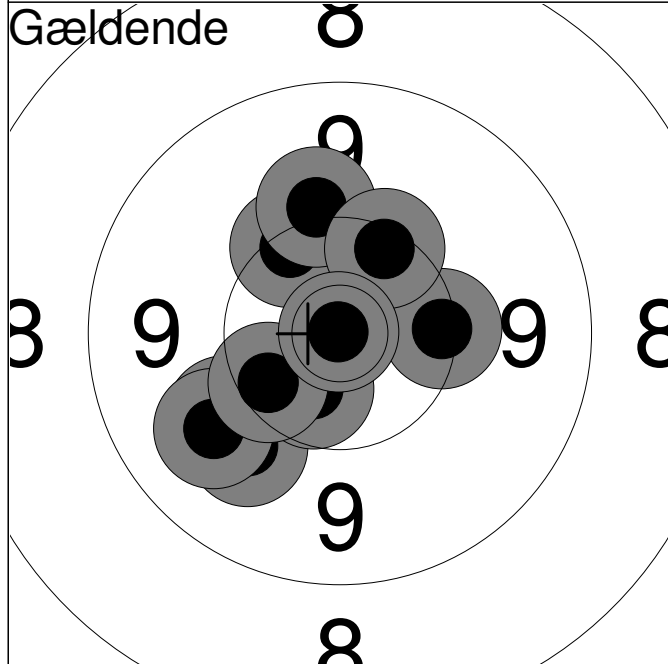

1:	10.3	→
2:	10.0	↖
3:	10.3	↗
4:	10.0	↘
5:	9.9	↖
6:	10.1	↑
7:	*10.5	↘
8:	10.4	↖
9:	10.3	↗
10:	*10.9	↗
Serie		99.0
Total		99.0

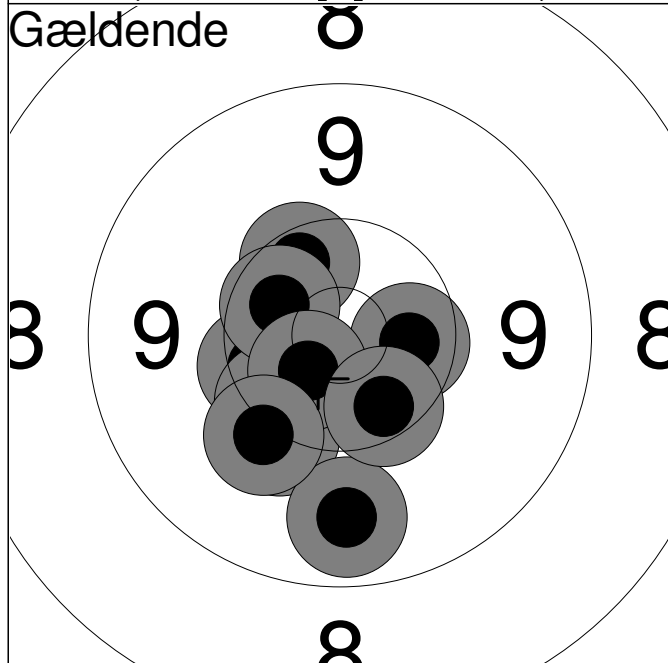

11:	10.3	↖
12:	10.3	↖
13:	10.4	↗
14:	10.1	↘
15:	*10.5	↗
16:	*10.5	→
17:	9.7	↘
18:	*10.6	↖
19:	10.4	↘
20:	10.1	↖
Serie		99.0
Total		198.0

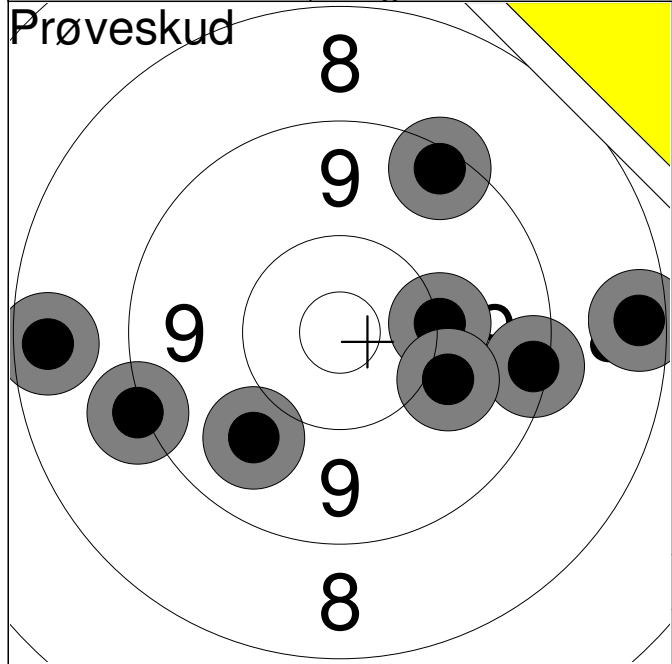

1:	9.3	↗
2:	8.4	→
3:	9.1	↖
4:	10.1	→
5:	9.8	↙
6:	9.3	→
7:	8.5	←
8:	10.0	↘
Serie		72.0
Total		0.0

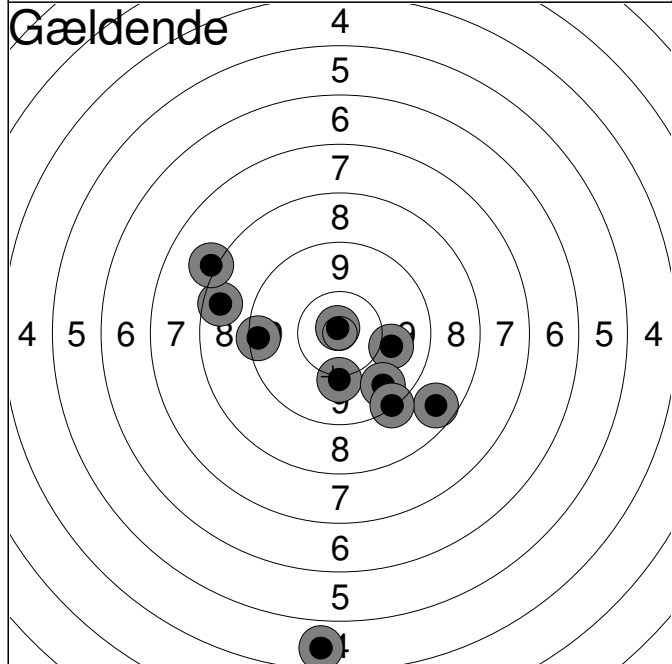

1:	8.5	↖
2:	10.0	→
3:	10.1	↓
4:	8.1	↗
5:	8.6	↙
6:	*10.8	↗
7:	9.7	↙
8:	9.4	←
9:	9.2	↙
10:	4.6	↓
Serie		85.0
Total		85.0

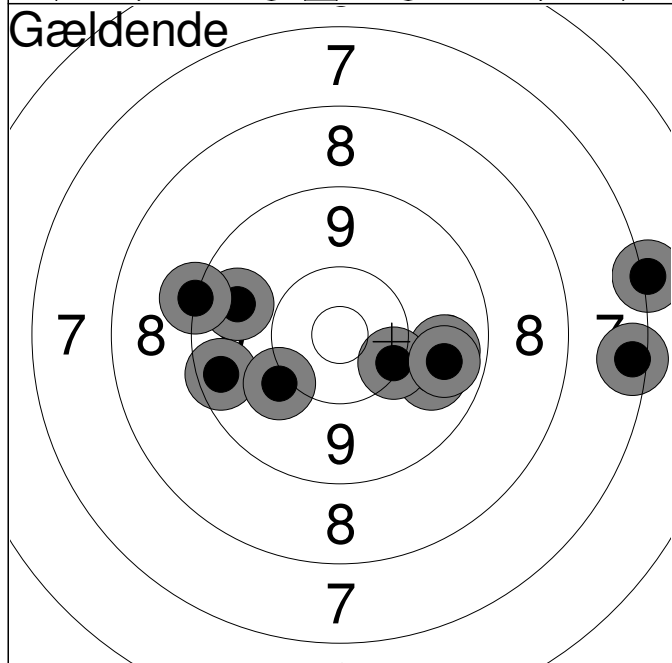

11:	7.4	→
12:	9.7	↖
13:	9.8	↘
14:	7.1	→
15:	9.5	←
16:	9.2	↖
17:	9.7	→
18:	10.3	↘
19:	10.1	↙
20:	9.7	→
Serie		88.0
Total		173.0

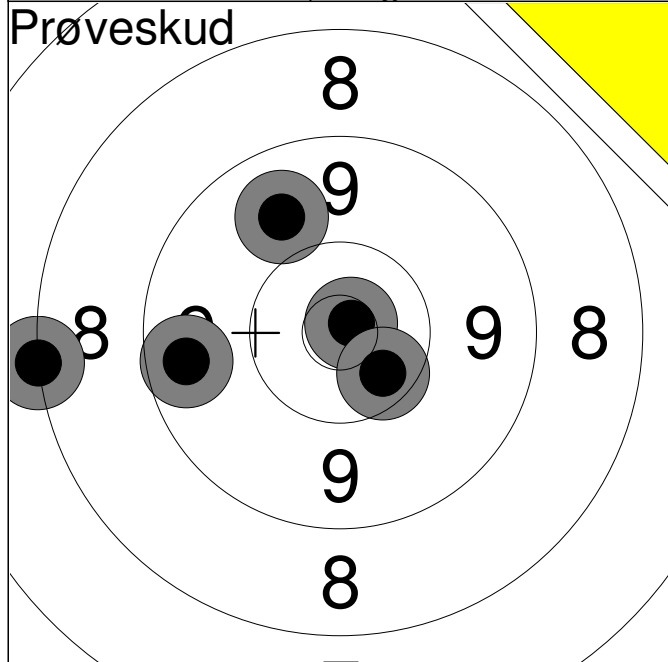

1:	8.2	←
2:	9.8	↑
3:	9.6	←
4:	*10.8	↗
5:	*10.4	↘
Serie		46.0
Total		0.0

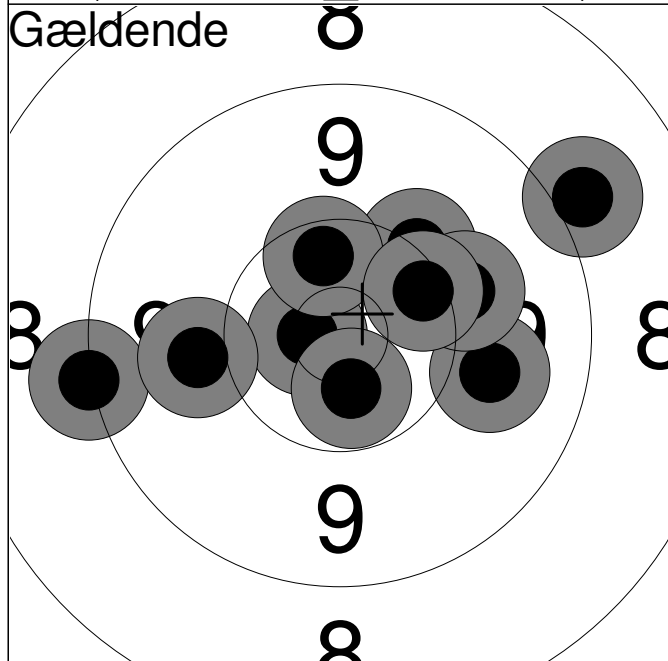

1:	10.2	↗
2:	9.1	←
3:	*10.7	←
4:	9.0	↗
5:	9.9	→
6:	*10.6	↓
7:	10.4	↑
8:	10.0	→
9:	10.3	↗
10:	10.0	←
Serie		97.0
Total		97.0

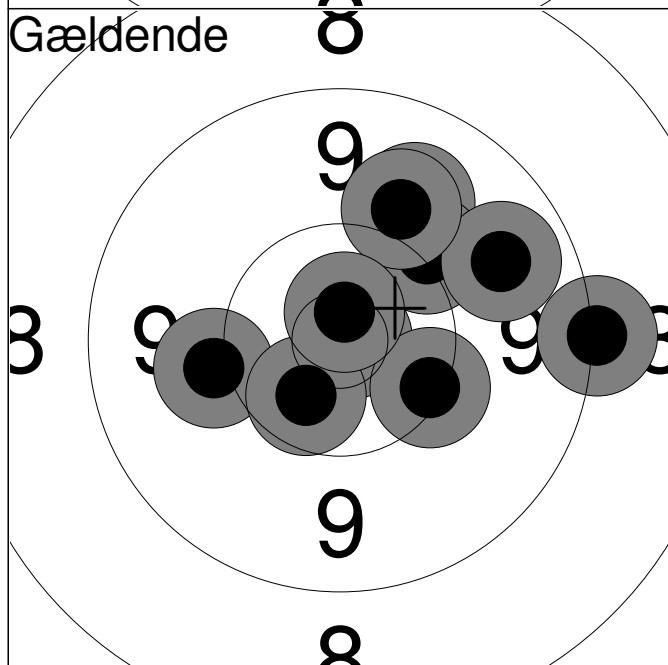

11:	*10.9	→
12:	9.9	↑
13:	10.1	↗
14:	10.1	←
15:	9.7	↗
16:	*10.5	↙
17:	10.0	↑
18:	10.3	↘
19:	9.1	→
20:	*10.8	↑
Serie		97.0
Total		194.0

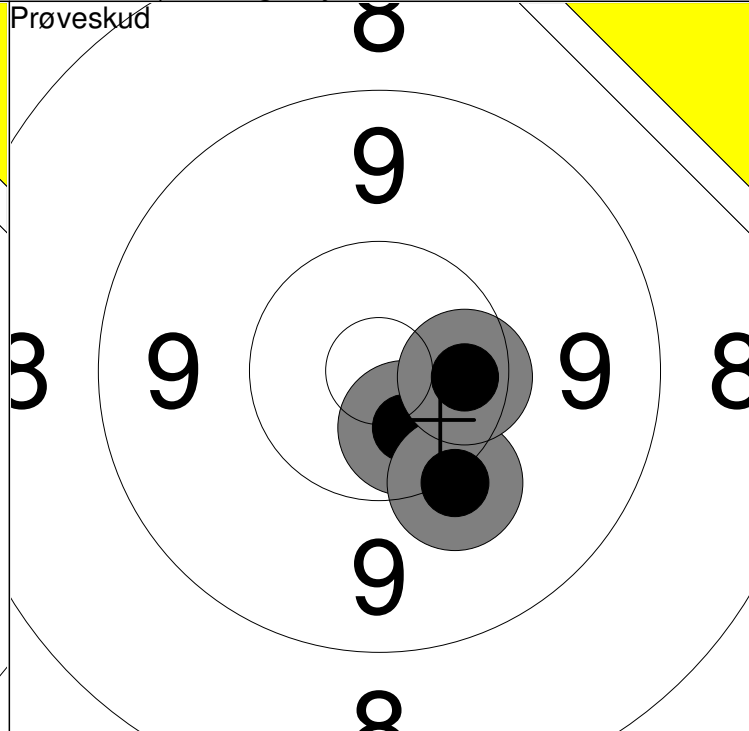
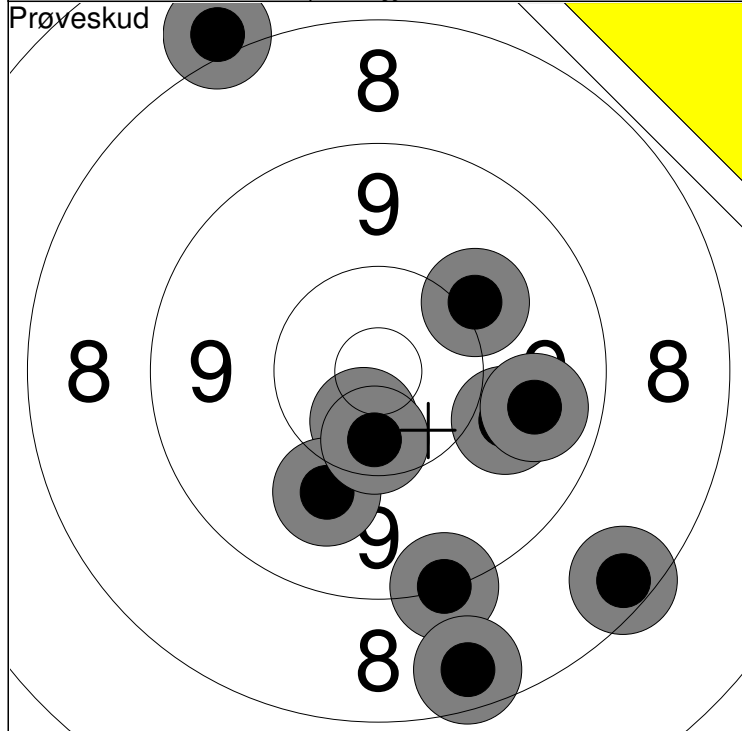

1: 8.0 ↗	6: 9.7 →	Serie 91
2: *10.6 ↓	7: 10.0 ↓	
3: 9.2 ↓	8: 10.1 ↗	Total 0
4: 8.5 ↓	9: *10.4 ↓	
5: 9.9 →	10: 8.4 ↘	

11: *10.6 ↓	Serie 30
12: 10.1 ↓	
13: *10.4 →	Total 0

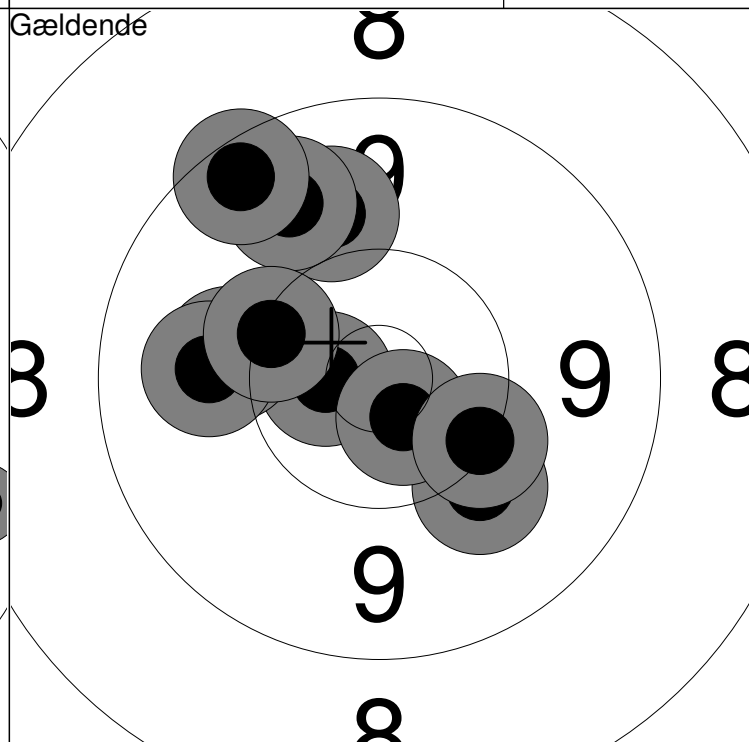
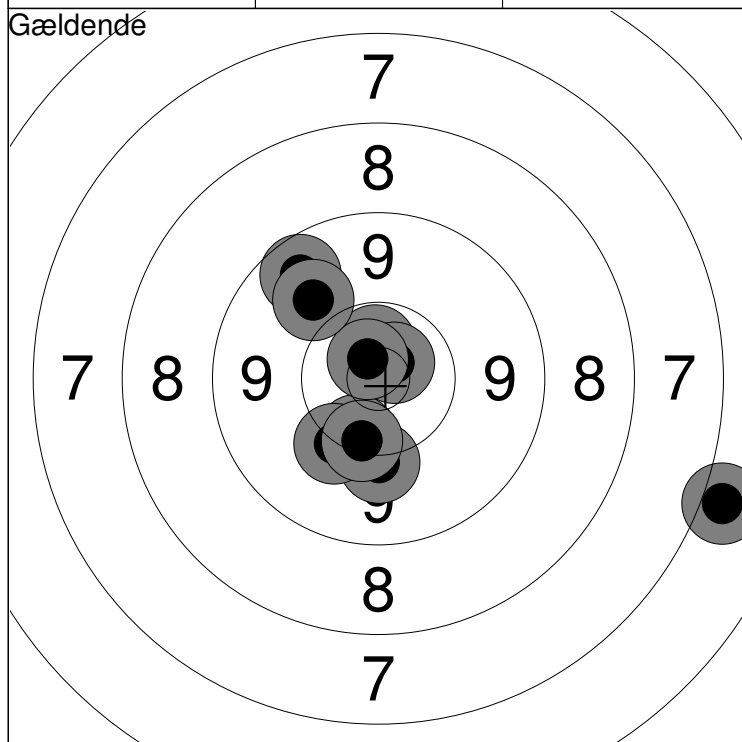

1: 9.6 ↗	6: *10.7 ↗	Serie 94
2: 10.1 ↓	7: *10.7 ↗	
3: 10.3 ↓	8: 9.9 ↗	Total 94
4: 6.9 →	9: 10.1 ↓	
5: *10.6 ↑	10: 10.3 ↓	

11: 10.0 ↓	16: 10.2 ↘	Serie 96
12: *10.6 ←	17: 10.0 ←	
13: 9.9 ↗	18: 9.9 ←	Total 190
14: *10.7 ↓	19: 10.2 ←	
15: 9.7 ↗	20: 9.4 ↗	

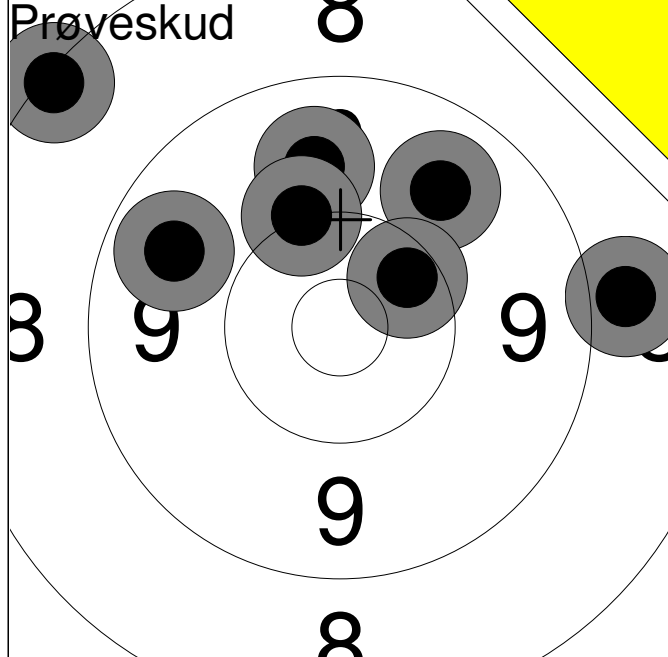

1:	9.8	↑
2:	8.9	→
3:	9.8	↗
4:	8.3	↗
5:	9.7	↖
6:	10.1	↑
7:	10.4	↗

Serie	63.0
Total	0.0

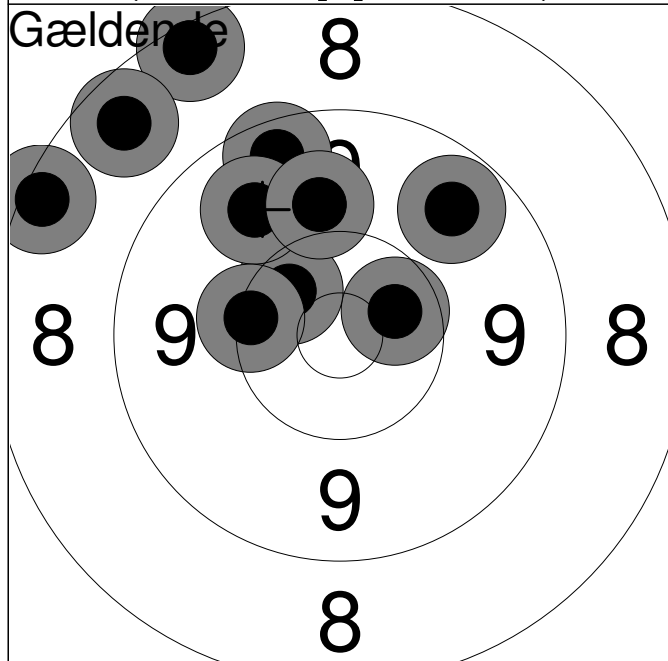

1:	*10.5	→
2:	9.6	↗
3:	8.4	↗
4:	9.5	↗
5:	8.5	↗
6:	8.3	↖
7:	*10.4	↗
8:	9.8	↗
9:	10.3	↖
10:	9.9	↑

Serie	90.0
Total	90.0

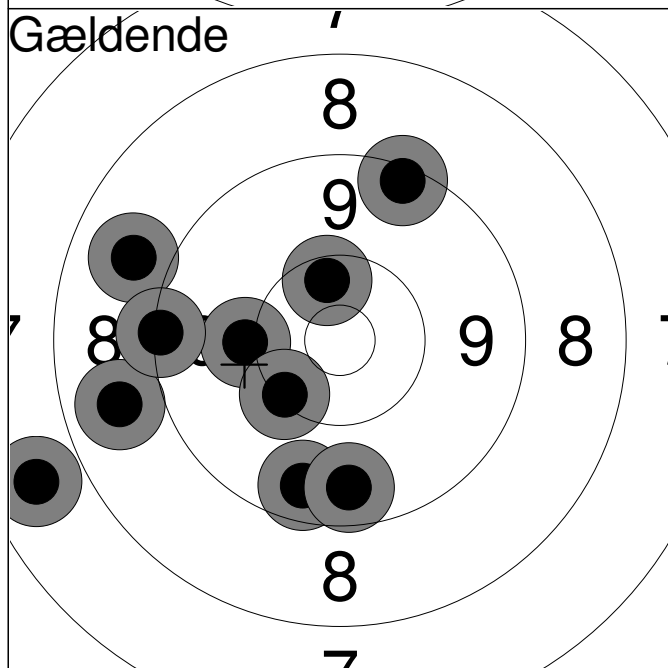

11:	9.5	↓
12:	9.6	↓
13:	10.1	←
14:	10.2	↖
15:	10.4	↑
16:	7.7	←
17:	8.8	↖
18:	9.3	↗
19:	8.7	←
20:	9.2	←

Serie	89.0
Total	179.0

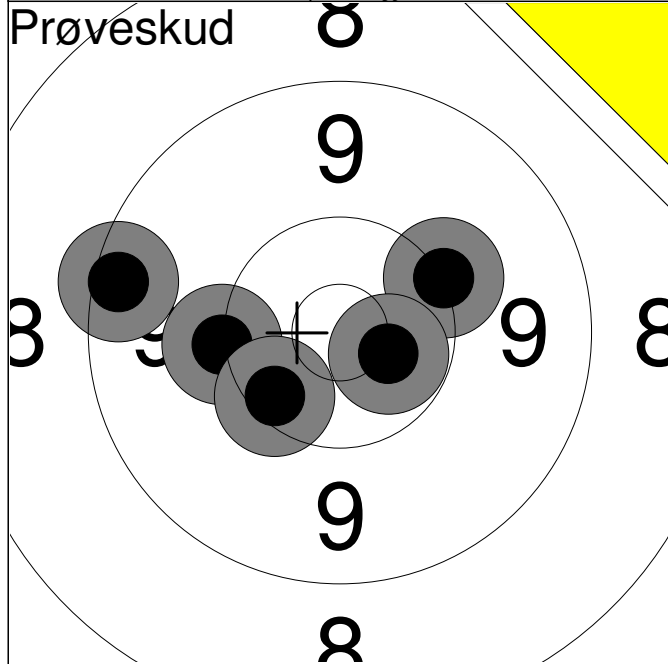

1:	10.1	↗
2:	9.4	↖
3:	*10.6	↘
4:	10.1	↖
5:	10.3	↙
Serie		49.0
Total		0.0

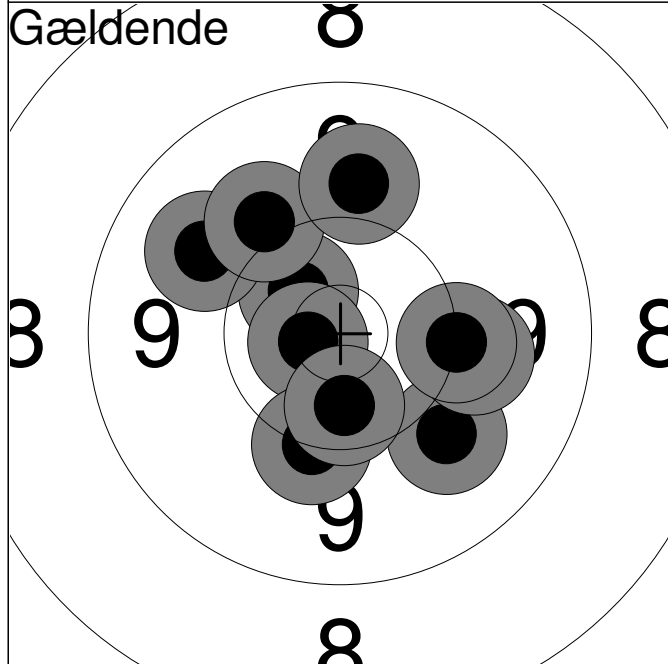

1:	*10.5	↗
2:	9.9	↗
3:	10.0	↘
4:	*10.7	↖
5:	10.0	↘
6:	10.0	↗
7:	10.2	↘
8:	10.2	→
9:	9.9	↑
10:	*10.5	↓
Serie		98.0
Total		98.0

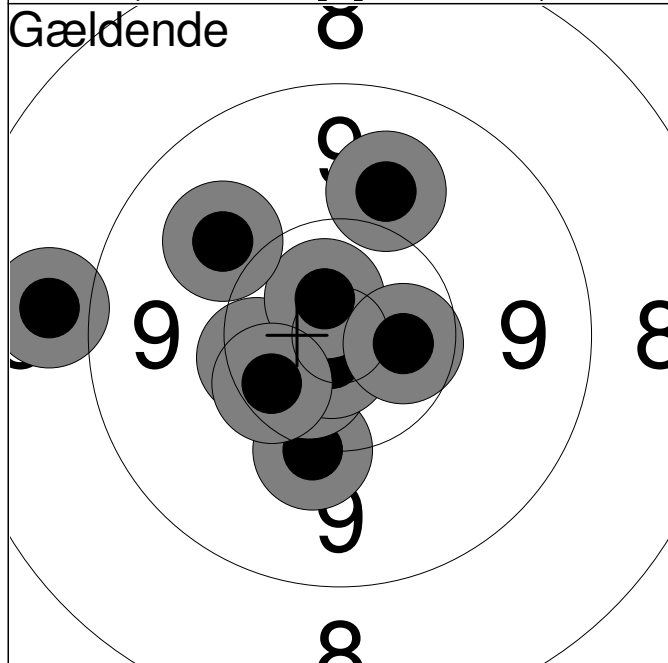

11:	10.4	↖
12:	10.1	↓
13:	*10.6	↙
14:	*10.8	↙
15:	*10.7	↗
16:	10.4	↖
17:	9.9	↗
18:	*10.5	→
19:	9.9	↗
20:	8.9	↖
Serie		96.0
Total		194.0

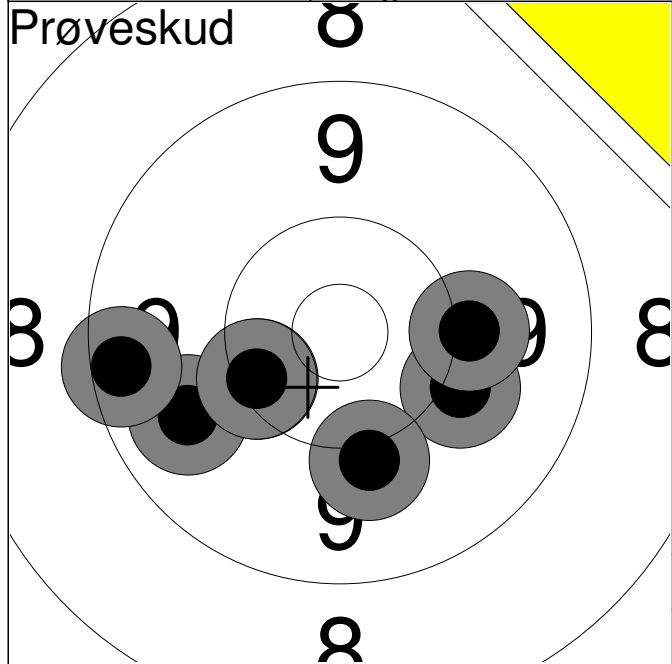

1:	9.8	←
2:	9.4	←
3:	10.0	→
4:	10.1	↓
5:	10.1	→
6:	10.3	←
7:	10.3	←
Serie		68.0
Total		0.0

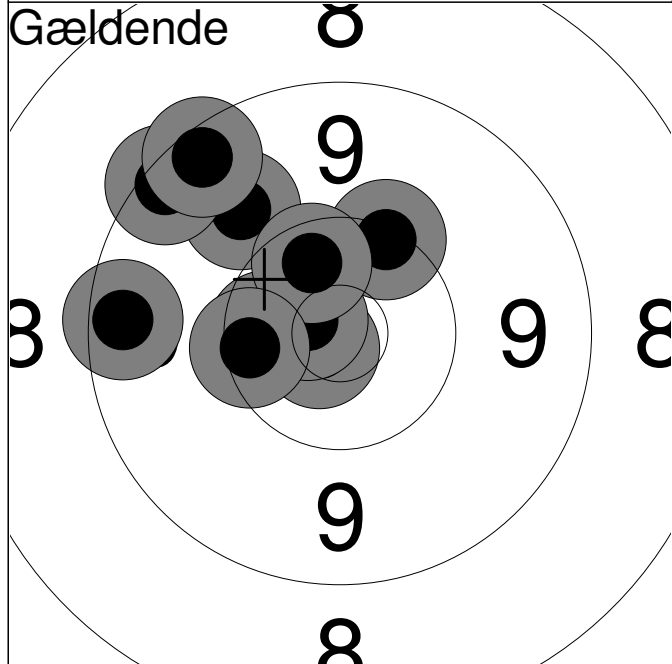

1:	10.2	↑
2:	9.9	↑
3:	*10.5	←
4:	*10.8	←
5:	*10.7	↑
6:	9.3	↑
7:	*10.4	↑
8:	9.4	↑
9:	9.4	←
10:	10.3	←
Serie		96.0
Total		96.0

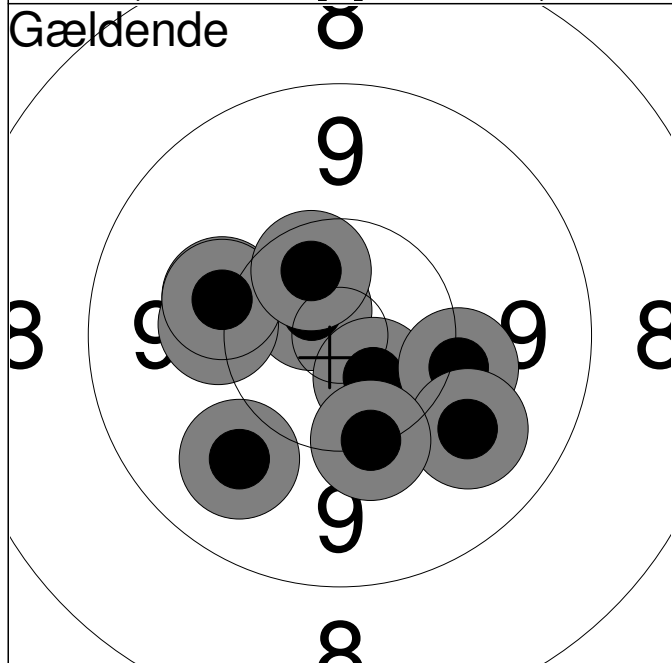

11:	10.1	←
12:	*10.7	↑
13:	9.9	←
14:	*10.6	↓
15:	10.1	↓
16:	9.9	↓
17:	10.1	←
18:	10.1	↑
19:	10.2	↓
20:	*10.5	↑
Serie		98.0
Total		194.0

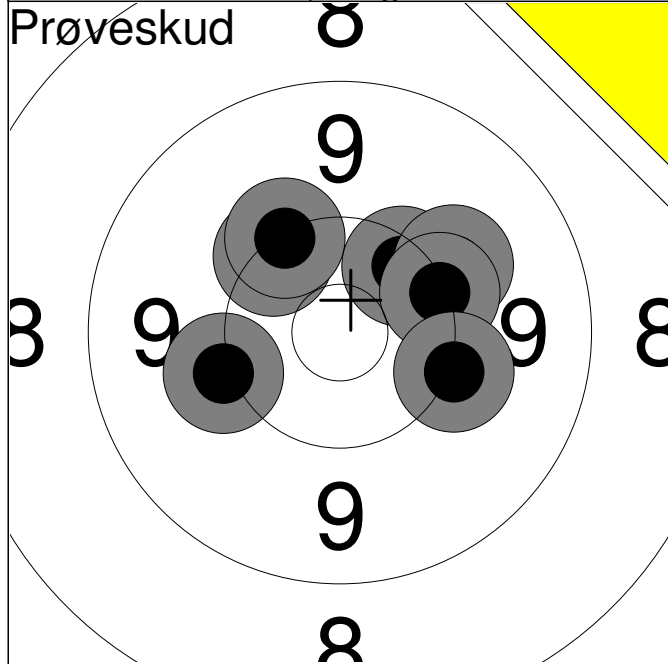

1:	10.3	↗
2:	10.2	↗
3:	10.3	↗
4:	10.0	↗
5:	10.2	↗
6:	10.1	→
7:	10.1	↖
Serie		70.0
Total		0.0

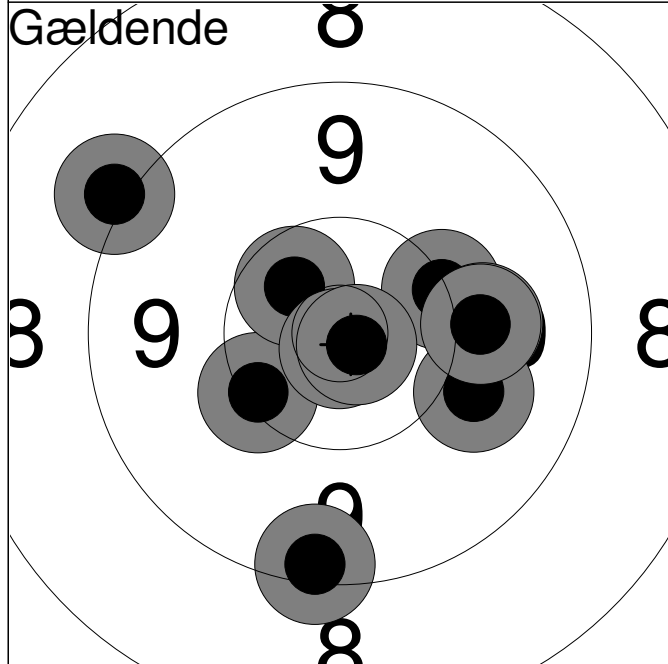

1:	10.3	↖
2:	9.3	↓
3:	10.2	↗
4:	*10.5	↗
5:	*10.8	↓
6:	10.0	→
7:	9.1	↗
8:	10.0	↘
9:	*10.8	↘
10:	10.0	→
Serie		98.0
Total		98.0

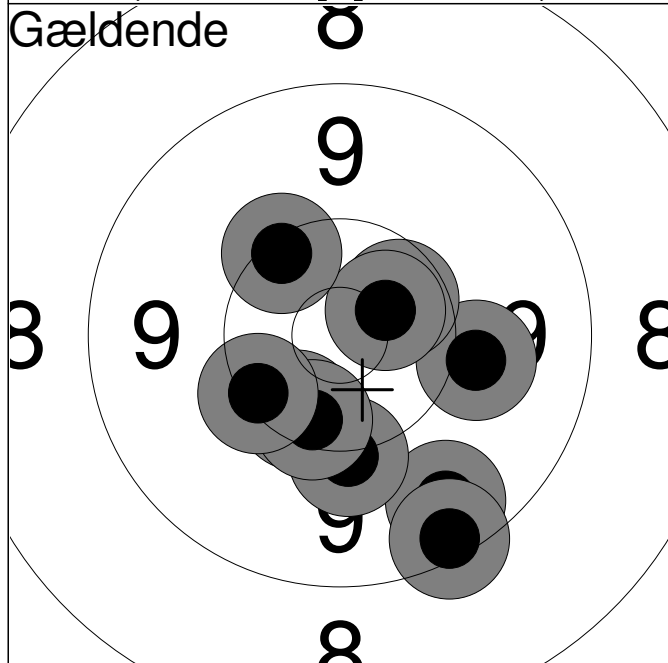

11:	9.6	↘
12:	10.4	↘
13:	10.0	→
14:	*10.5	↗
15:	*10.6	↗
16:	10.1	↓
17:	9.3	↘
18:	10.3	↘
19:	10.3	↖
20:	10.3	↗
Serie		98.0
Total		196.0

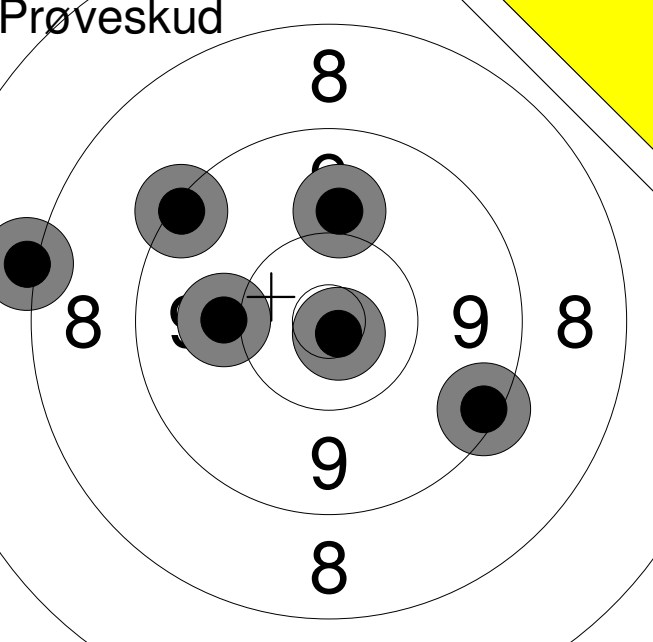
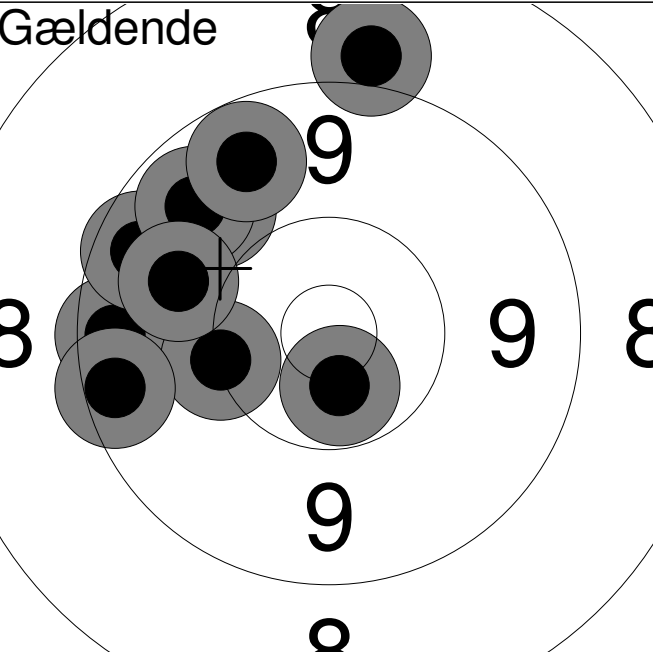
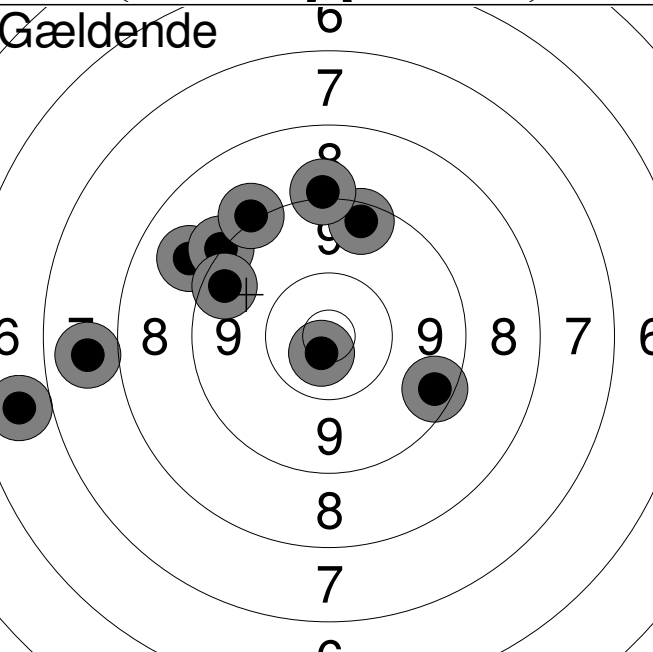
	Nordjysk Mesterskab 2013	Aalborg Skyttekreds																													
<p>Prøveskud</p> 	<table style="width:100%; border-collapse: collapse;"> <tr><td style="width:10%;">1:</td><td style="width:70%;">9.3</td><td style="width:20%; text-align: right;">↗</td></tr> <tr><td>2:</td><td>9.3</td><td style="text-align: right;">↘</td></tr> <tr><td>3:</td><td>*10.8</td><td style="text-align: right;">↘</td></tr> <tr><td>4:</td><td>10.0</td><td style="text-align: right;">↑</td></tr> <tr><td>5:</td><td>8.1</td><td style="text-align: right;">←</td></tr> <tr><td>6:</td><td>10.0</td><td style="text-align: right;">←</td></tr> </table>	1:	9.3	↗	2:	9.3	↘	3:	*10.8	↘	4:	10.0	↑	5:	8.1	←	6:	10.0	←												
1:	9.3	↗																													
2:	9.3	↘																													
3:	*10.8	↘																													
4:	10.0	↑																													
5:	8.1	←																													
6:	10.0	←																													
		Serie 56.0																													
		Total 0.0																													
<p>Gældende</p> 	<table style="width:100%; border-collapse: collapse;"> <tr><td style="width:10%;">1:</td><td style="width:70%;">9.5</td><td style="width:20%; text-align: right;">←</td></tr> <tr><td>2:</td><td>10.2</td><td style="text-align: right;">←</td></tr> <tr><td>3:</td><td>9.0</td><td style="text-align: right;">↑</td></tr> <tr><td>4:</td><td>9.8</td><td style="text-align: right;">↗</td></tr> <tr><td>5:</td><td>9.4</td><td style="text-align: right;">←</td></tr> <tr><td>6:</td><td>*10.6</td><td style="text-align: right;">↘</td></tr> <tr><td>7:</td><td>9.5</td><td style="text-align: right;">↗</td></tr> <tr><td>8:</td><td>9.7</td><td style="text-align: right;">↗</td></tr> <tr><td>9:</td><td>9.9</td><td style="text-align: right;">↗</td></tr> <tr><td>10:</td><td>9.6</td><td style="text-align: right;">↗</td></tr> </table>	1:	9.5	←	2:	10.2	←	3:	9.0	↑	4:	9.8	↗	5:	9.4	←	6:	*10.6	↘	7:	9.5	↗	8:	9.7	↗	9:	9.9	↗	10:	9.6	↗
1:	9.5	←																													
2:	10.2	←																													
3:	9.0	↑																													
4:	9.8	↗																													
5:	9.4	←																													
6:	*10.6	↘																													
7:	9.5	↗																													
8:	9.7	↗																													
9:	9.9	↗																													
10:	9.6	↗																													
		Serie 92.0																													
		Total 92.0																													
<p>Gældende</p> 	<table style="width:100%; border-collapse: collapse;"> <tr><td style="width:10%;">11:</td><td style="width:70%;">7.8</td><td style="width:20%; text-align: right;">←</td></tr> <tr><td>12:</td><td>9.4</td><td style="text-align: right;">↑</td></tr> <tr><td>13:</td><td>8.9</td><td style="text-align: right;">↗</td></tr> <tr><td>14:</td><td>6.7</td><td style="text-align: right;">←</td></tr> <tr><td>15:</td><td>9.2</td><td style="text-align: right;">↗</td></tr> <tr><td>16:</td><td>9.1</td><td style="text-align: right;">↗</td></tr> <tr><td>17:</td><td>9.5</td><td style="text-align: right;">↗</td></tr> <tr><td>18:</td><td>9.4</td><td style="text-align: right;">↘</td></tr> <tr><td>19:</td><td>9.1</td><td style="text-align: right;">↑</td></tr> <tr><td>20:</td><td>*10.7</td><td style="text-align: right;">↘</td></tr> </table>	11:	7.8	←	12:	9.4	↑	13:	8.9	↗	14:	6.7	←	15:	9.2	↗	16:	9.1	↗	17:	9.5	↗	18:	9.4	↘	19:	9.1	↑	20:	*10.7	↘
11:	7.8	←																													
12:	9.4	↑																													
13:	8.9	↗																													
14:	6.7	←																													
15:	9.2	↗																													
16:	9.1	↗																													
17:	9.5	↗																													
18:	9.4	↘																													
19:	9.1	↑																													
20:	*10.7	↘																													
		Serie 85.0																													
		Total 177.0																													

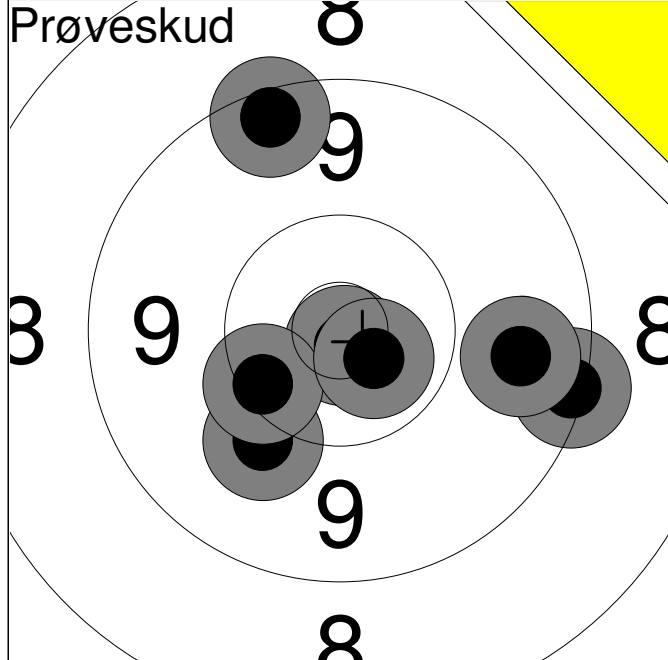

1:	9.4	↑
2:	10.0	↓
3:	*10.8	↓
4:	9.3	→
5:	9.7	→
6:	10.3	↓
7:	*10.6	↓
Serie		67.0
Total		0.0

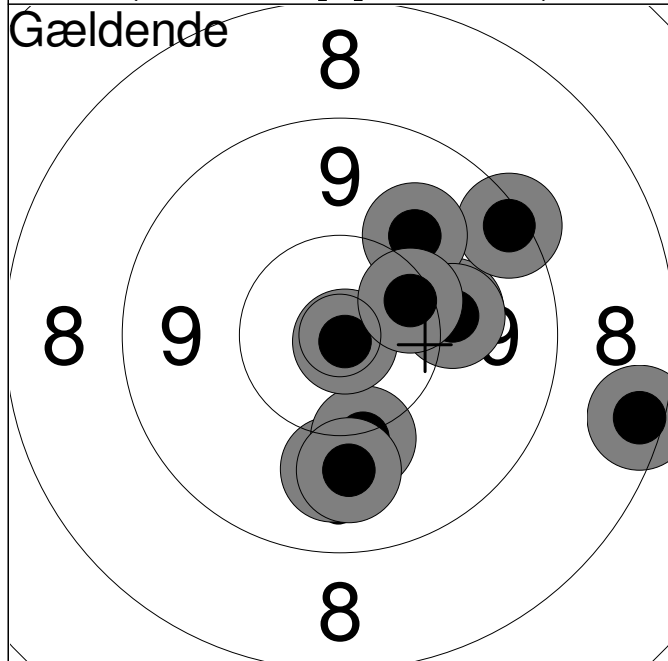

1:	9.9	↓
2:	8.4	→
3:	10.1	→
4:	10.1	↓
5:	9.9	↓
6:	9.3	↗
7:	10.0	↗
8:	*10.9	↓
9:	10.0	→
10:	10.3	↗
Serie		95.0
Total		95.0

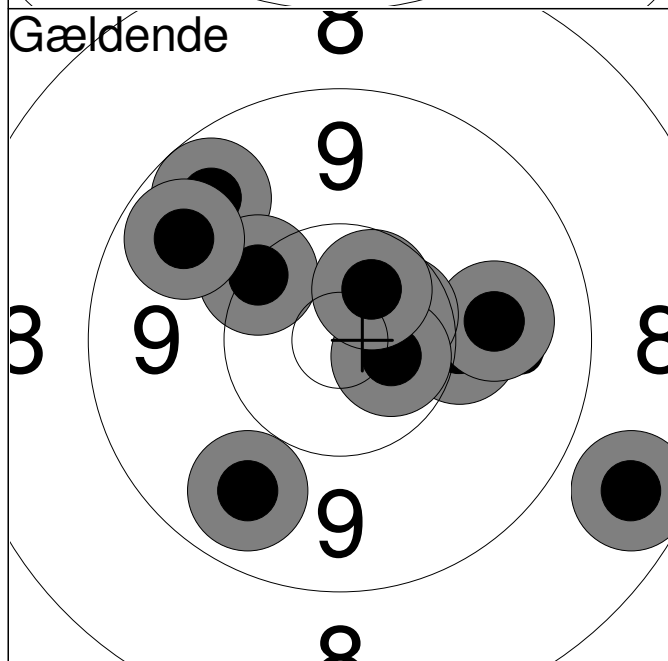

11:	10.1	→
12:	8.6	↓
13:	9.6	↗
14:	9.7	↓
15:	10.2	↗
16:	9.9	→
17:	*10.5	↗
18:	*10.6	→
19:	9.7	↗
20:	*10.5	↗
Serie		94.0
Total		189.0

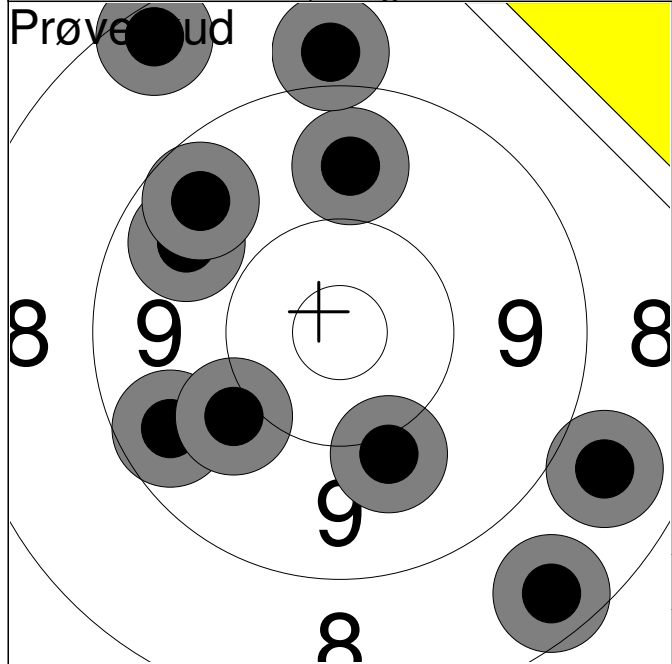

1:	10.0	↓
2:	9.6	↙
3:	10.0	↙
4:	8.5	↓
5:	8.8	↘
6:	9.8	↑
7:	8.9	↑
8:	8.4	↗
9:	9.7	↗
10:	9.6	↗
Serie		88.0
Total		0.0

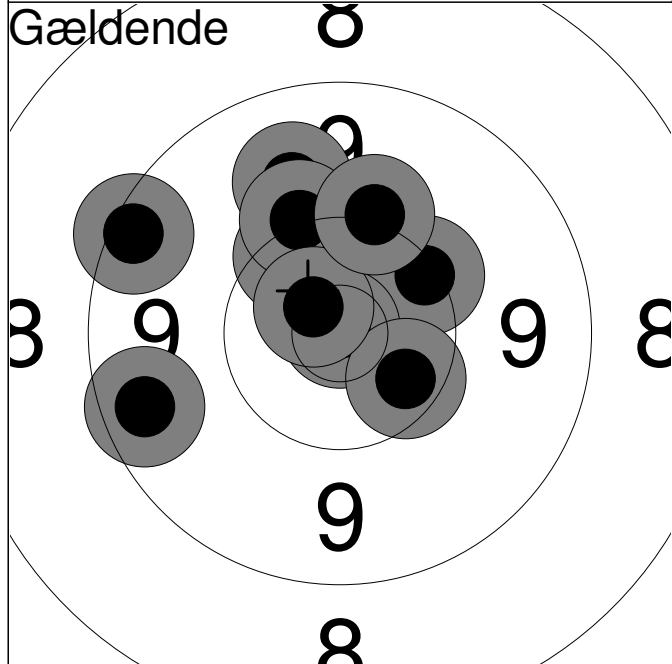

1:	10.2	↗
2:	*10.9	↑
3:	10.4	↘
4:	10.3	↗
5:	9.9	↑
6:	10.1	↑
7:	9.5	↙
8:	*10.7	↗
9:	9.3	↗
10:	10.1	↑
Serie		97.0
Total		97.0

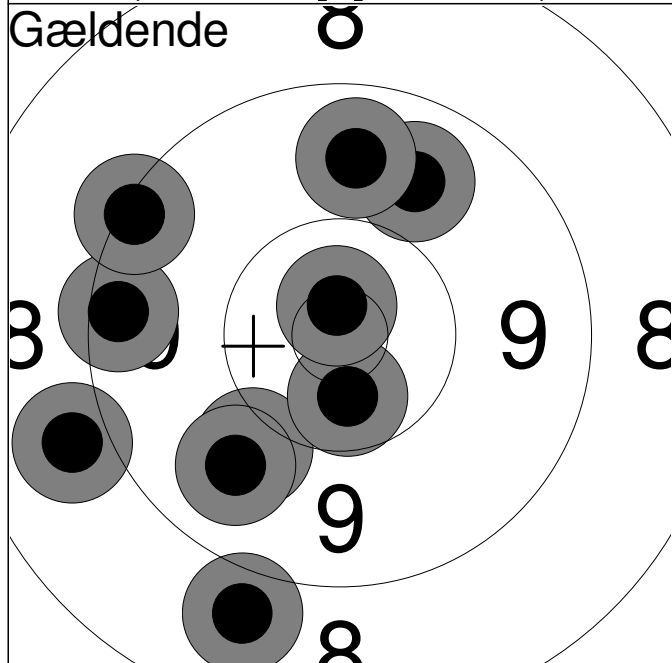

11:	9.8	↗
12:	10.0	↙
13:	8.9	↓
14:	9.4	↙
15:	8.9	↙
16:	9.3	↗
17:	9.8	↙
18:	9.7	↑
19:	*10.5	↓
20:	*10.7	↑
Serie		91.0
Total		188.0

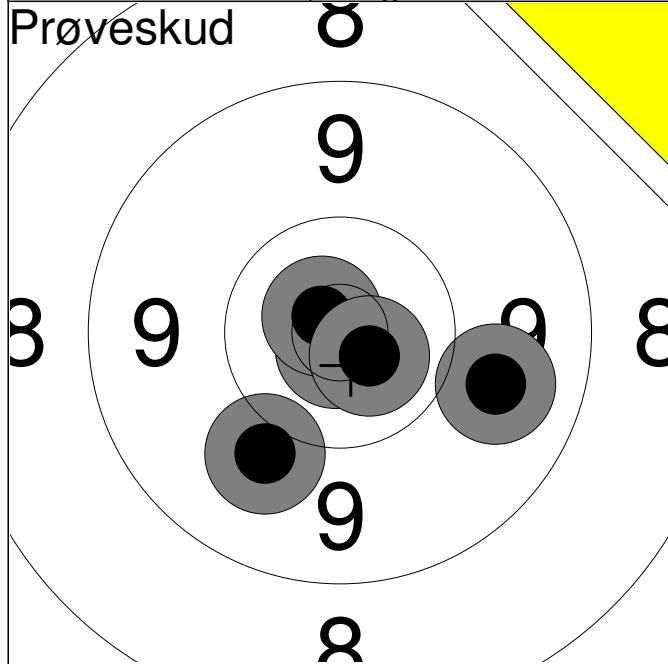

1:	9.8	→
2:	10.0	↙
3:	*10.8	↘
4:	*10.8	↗
5:	*10.7	↘
Serie		49.0
Total		0.0

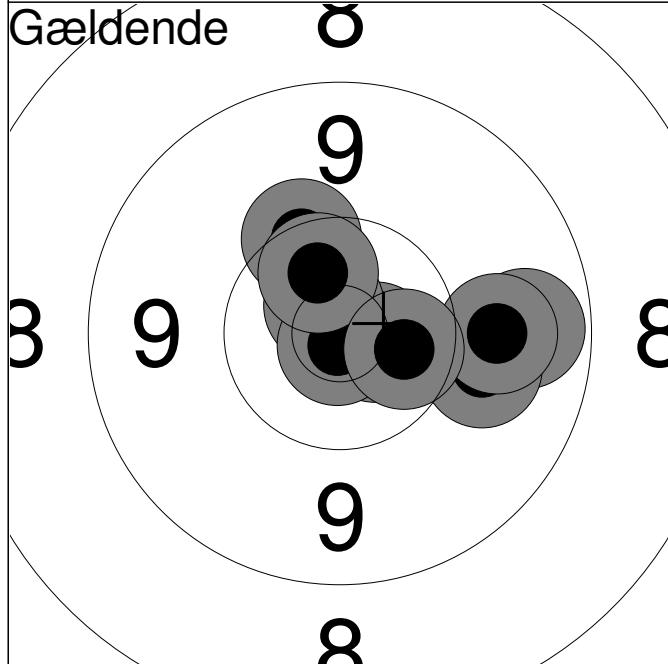

1:	9.7	→
2:	*10.7	→
3:	*10.9	↘
4:	10.0	→
5:	*10.7	↗
6:	10.3	↗
7:	9.9	→
8:	*10.9	↘
9:	*10.5	↗
10:	*10.5	→
Serie		98.0
Total		98.0

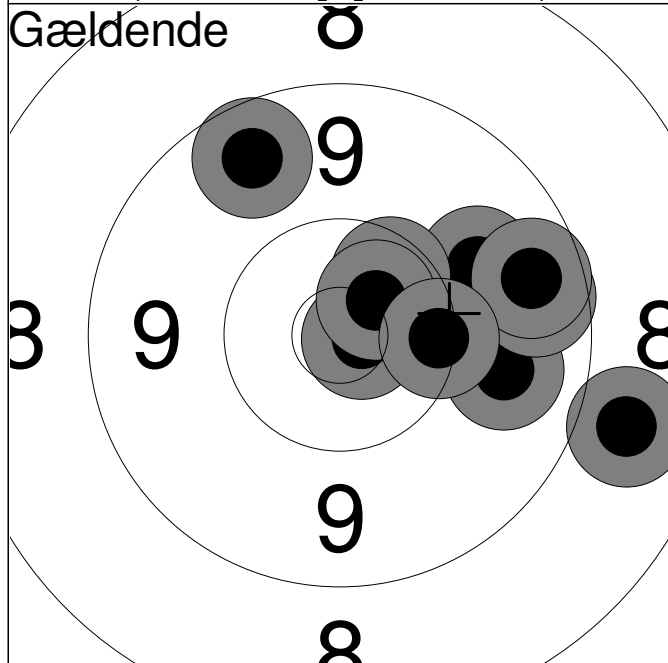

11:	9.6	↗
12:	*10.8	→
13:	9.9	↗
14:	8.8	→
15:	*10.4	↗
16:	*10.6	↗
17:	9.8	→
18:	9.6	→
19:	9.6	→
20:	10.3	→
Serie		93.0
Total		191.0

Hold 59	Skive 8	Dennis Nielsen	
-------------------	-------------------	-----------------------	--

50m	Hjørring Skytteforening	M2	
-----	-------------------------	----	--

	Nordjysk Mesterskab 2013	Aalborg Skyttekreds	
--	--------------------------	---------------------	--

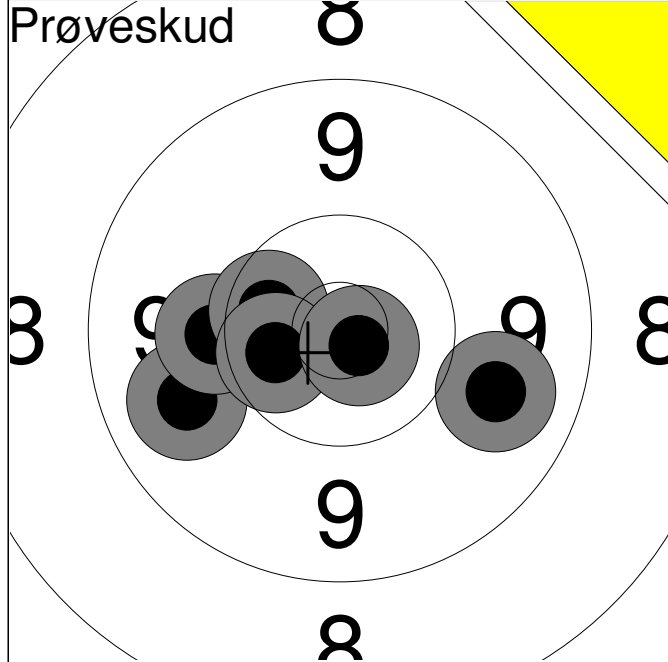

1:	9.8	←
2:	10.1	←
3:	*10.4	←
4:	9.8	→
5:	*10.5	←
6:	*10.8	↘
Serie		58.0
Total		0.0

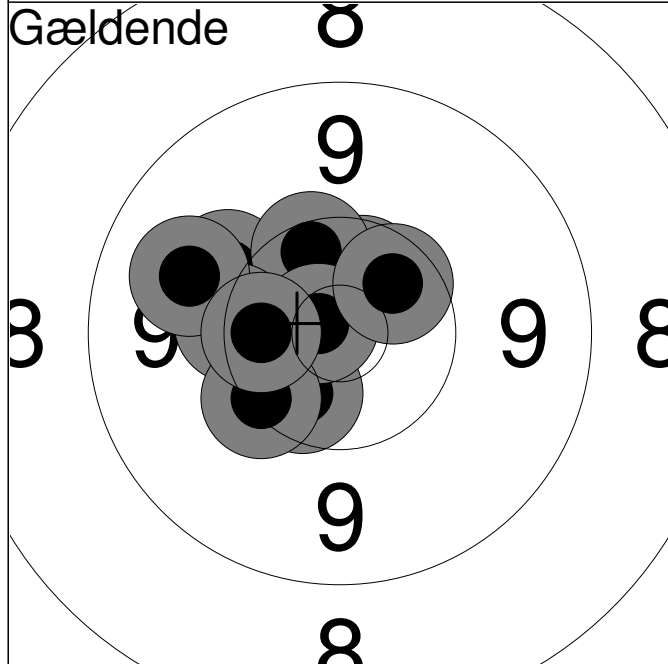

1:	*10.5	↙
2:	10.1	↖
3:	*10.5	↗
4:	10.4	↗
5:	10.2	←
6:	*10.8	↖
7:	10.3	↙
8:	9.8	↖
9:	10.4	←
10:	*10.5	↗
Serie		99.0
Total		99.0

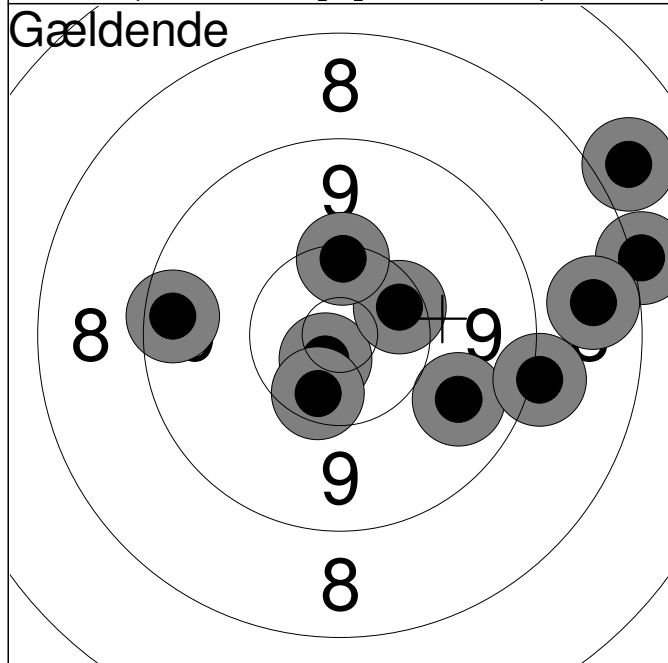

11:	9.8	→
12:	7.9	↗
13:	9.1	→
14:	9.4	←
15:	8.1	→
16:	*10.7	↙
17:	8.6	→
18:	10.4	↗
19:	10.4	↙
20:	10.3	↑
Serie		90.0
Total		189.0

Hold 59	Skive 9	Karsten Abildgaard	
-------------------	-------------------	---------------------------	--

50m	Hobro Egnens Skytteforening	ÅK1
-----	-----------------------------	-----

	Nordjysk Mesterskab 2013	Aalborg Skyttekreds
--	--------------------------	---------------------

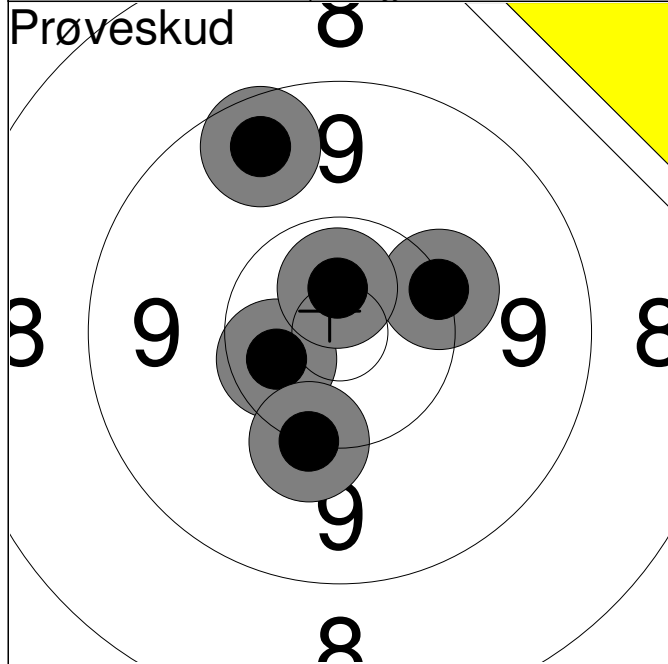

1:	9.5	↑
2:	10.2	→
3:	*10.5	←
4:	10.2	↓
5:	*10.6	↑
Serie		49.0
Total		0.0

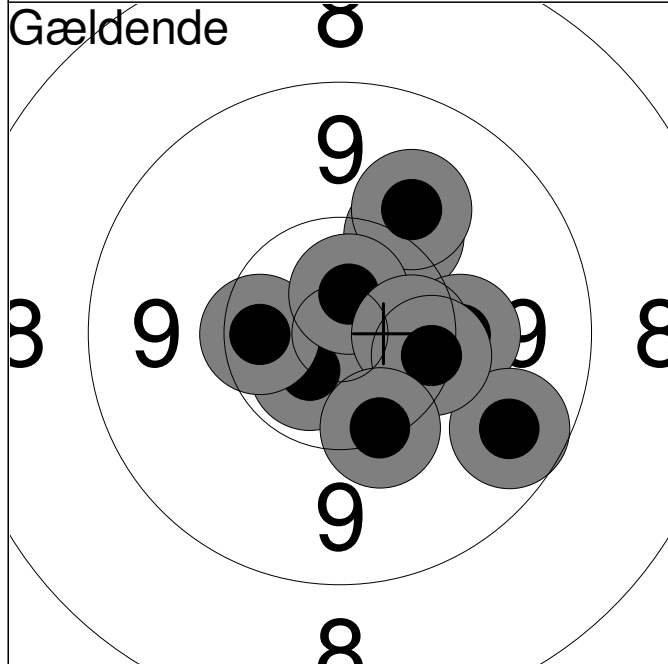

1:	*10.6	↙
2:	10.2	↗
3:	10.4	←
4:	10.0	↗
5:	10.1	→
6:	*10.7	↑
7:	*10.5	→
8:	9.6	↘
9:	10.3	→
10:	10.2	↓
Serie		99.0
Total		99.0

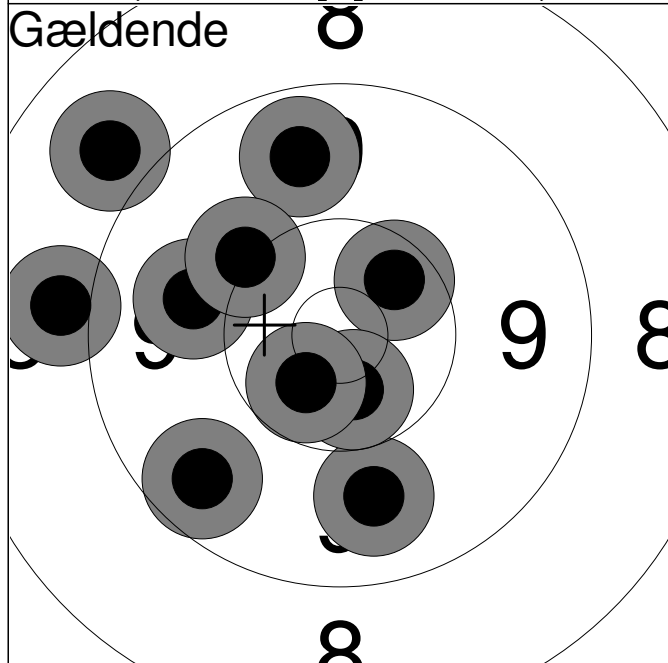

11:	9.8	↓
12:	*10.4	↗
13:	9.7	↑
14:	*10.6	↓
15:	9.6	↙
16:	9.0	←
17:	8.9	↗
18:	9.9	←
19:	*10.6	↙
20:	10.1	↗
Serie		93.0
Total		192.0

Hold	Skive	Klaus Svindborg	
59	10		

50m	Vodskov Skytteforening	MÅ1
-----	------------------------	-----

	Nordjysk Mesterskab 2013	Aalborg Skyttekreds
--	--------------------------	---------------------



1:	8.1	→
2:	*10.6	↓
3:	9.9	↙
4:	10.3	→
5:	9.4	↘
6:	*10.7	↗
7:	*10.6	↖
Serie		66.0
Total		0.0

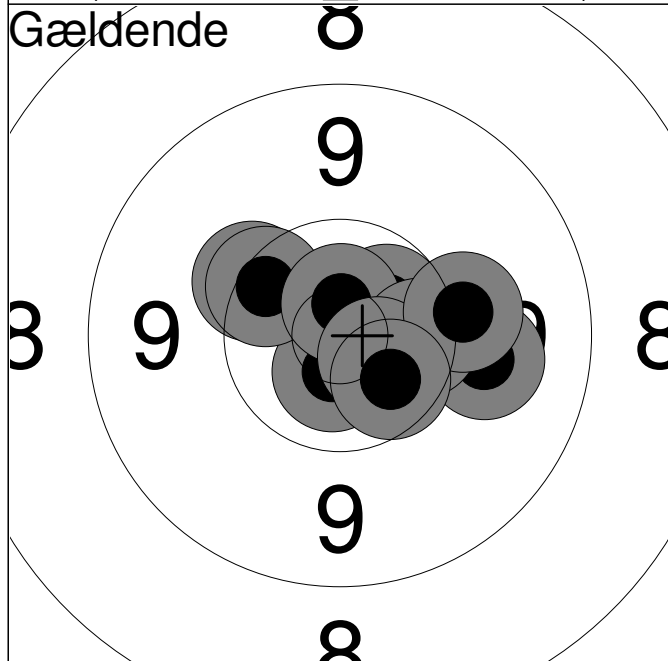

1:	10.2	↖
2:	*10.7	↓
3:	10.3	↗
4:	*10.6	↗
5:	10.0	→
6:	*10.7	↑
7:	10.4	→
8:	*10.7	↘
9:	10.1	→
10:	*10.5	↓
Serie		100.0
Total		100.0

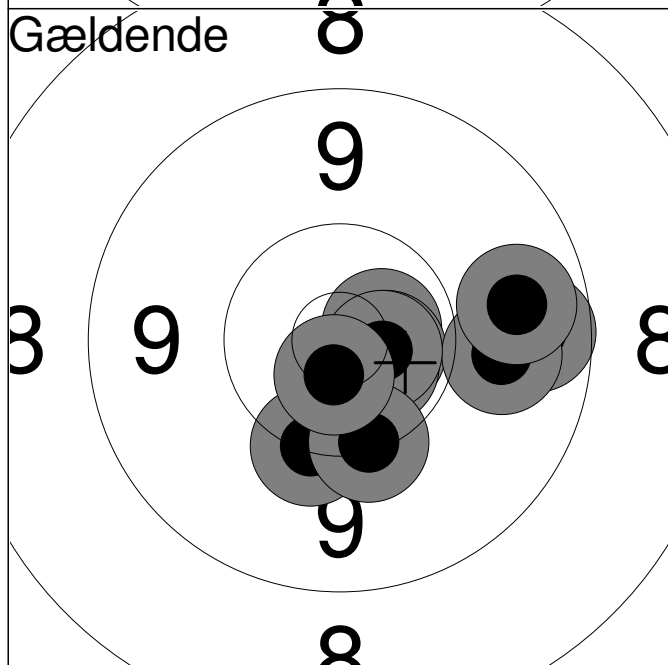

11:	9.6	→
12:	10.2	↓
13:	*10.7	→
14:	*10.6	→
15:	9.8	→
16:	9.7	→
17:	*10.6	↘
18:	*10.7	→
19:	10.2	↓
20:	*10.7	↓
Serie		97.0
Total		197.0

Hold 59	Skive 11	Lars Jakobsen	
-------------------	--------------------	----------------------	--

50m	Vilsted Skf.	MÅ1
-----	--------------	-----

	Nordjysk Mesterskab 2013	Aalborg Skyttekreds
--	--------------------------	---------------------

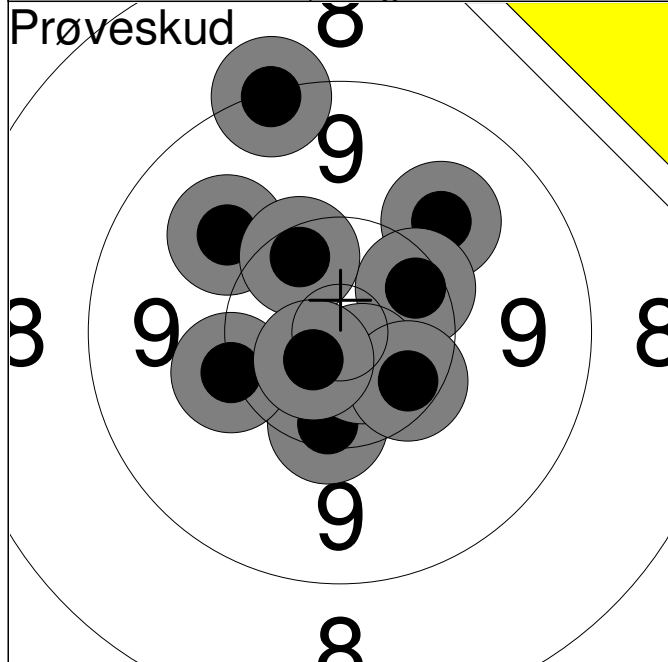

1:	9.2	↑
2:	9.9	↗
3:	9.9	↗
4:	10.4	↗
5:	10.3	↓
6:	10.4	↗
7:	10.2	↖
8:	*10.7	↓
9:	10.4	↘
10:	*10.7	↙
Serie		97.0
Total		0.0

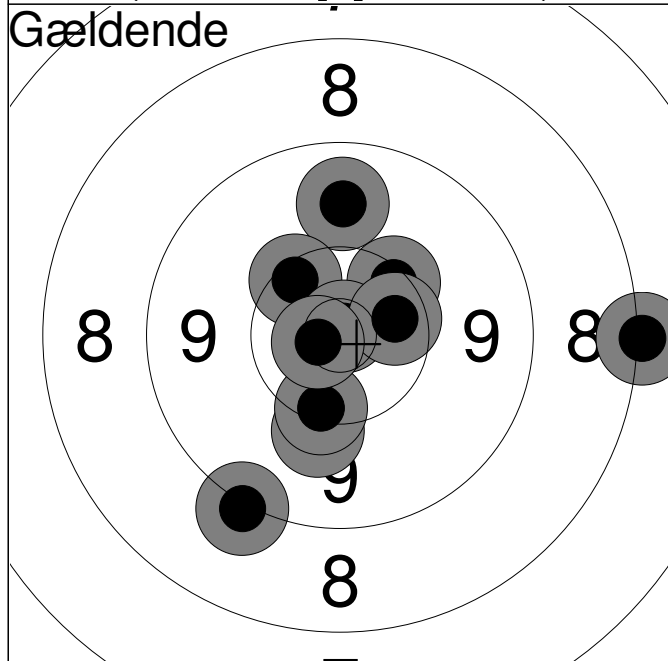

1:	9.8	↑
2:	10.3	↗
3:	8.1	→
4:	10.3	↗
5:	*10.9	↗
6:	*10.4	→
7:	10.1	↓
8:	10.3	↓
9:	*10.7	↖
10:	9.1	↙
Serie		96.0
Total		96.0

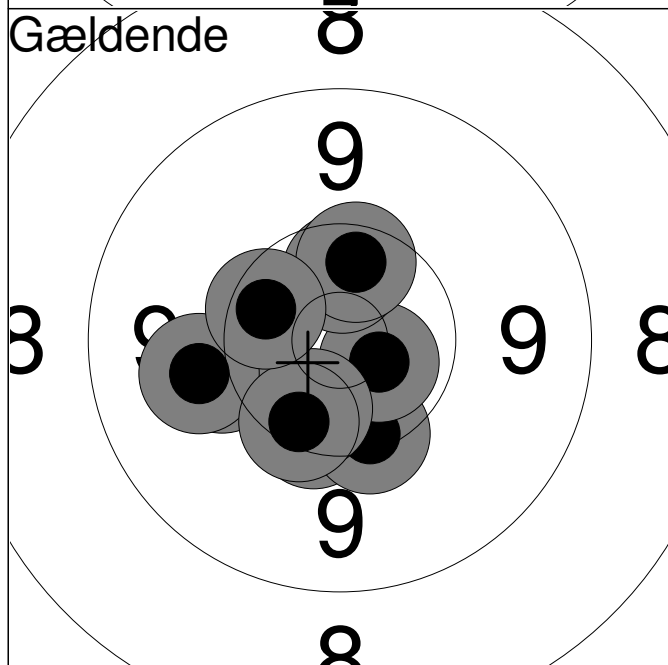

11:	10.3	↓
12:	10.3	↓
13:	*10.6	↘
14:	*10.4	↓
15:	10.1	↖
16:	10.0	↖
17:	*10.5	↑
18:	10.4	↑
19:	10.3	↘
20:	10.4	↖
Serie		100.0
Total		196.0

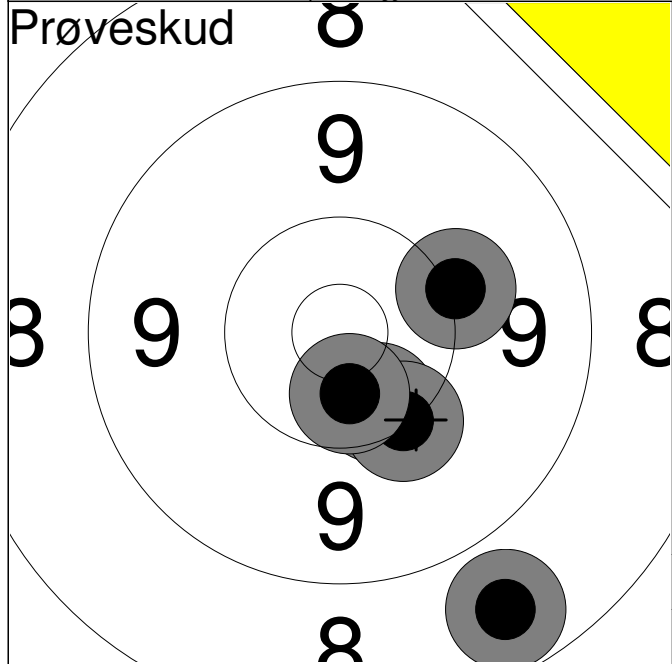

1:	10.4	↓
2:	10.2	↓
3:	8.6	↓
4:	10.1	→
5:	*10.5	↓
Serie		48.0
Total		0.0

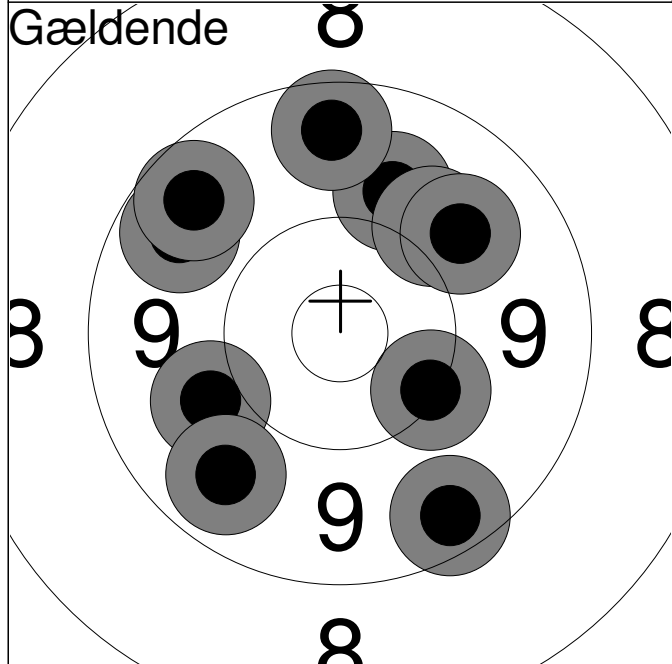

1:	9.9	↑
2:	9.6	↗
3:	10.2	↓
4:	10.0	↗
5:	9.6	↗
6:	10.0	↖
7:	9.9	↗
8:	9.5	↓
9:	9.7	↖
10:	9.5	↑
Serie		93.0
Total		93.0

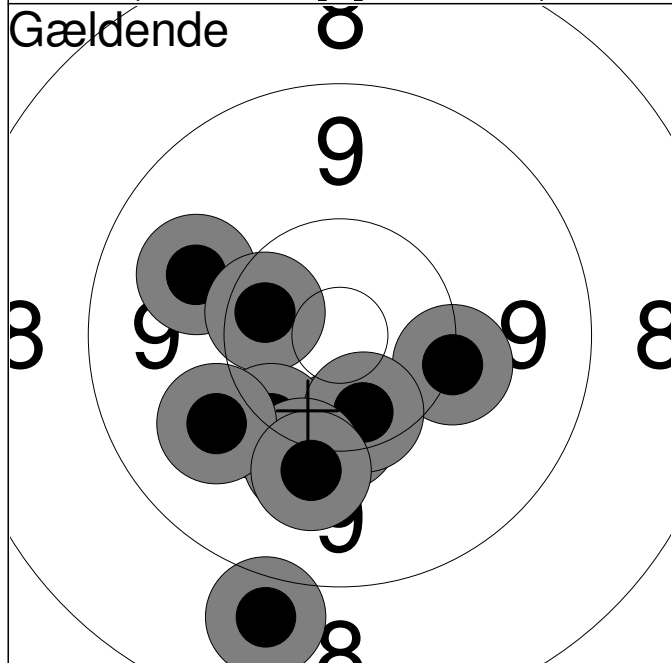

11:	9.9	↖
12:	10.3	↓
13:	8.9	↓
14:	10.2	→
15:	*10.4	↖
16:	10.2	↖
17:	10.4	↓
18:	10.1	↓
19:	9.9	↖
20:	10.0	↓
Serie		96.0
Total		189.0

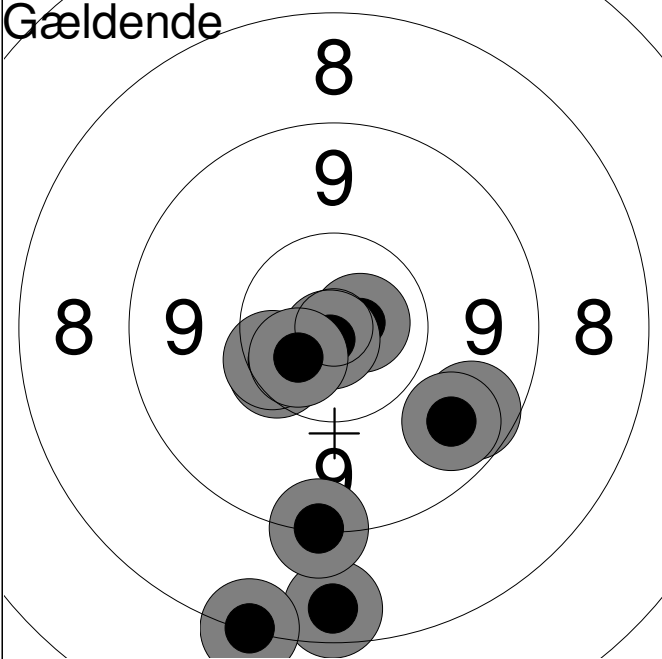
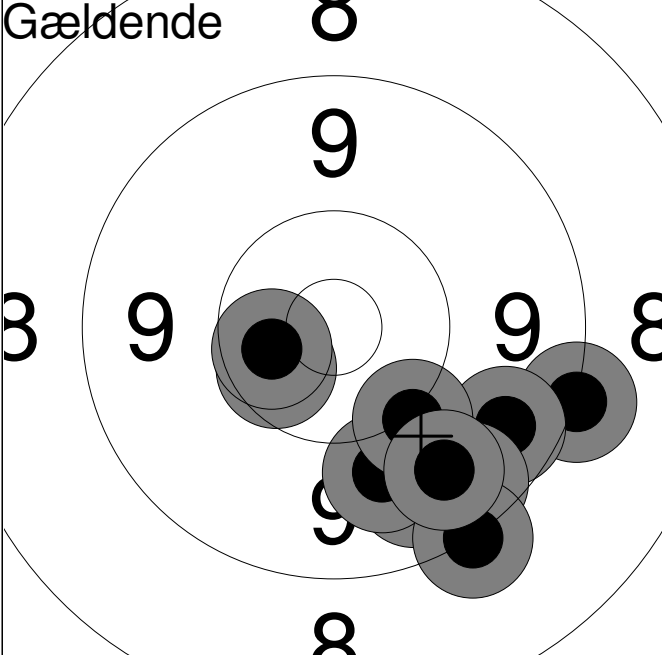
Hold	Skive	Simon Pedersen		
60	3	Sæby og Omegns Skytteforening		MB2
50m	Nordjysk Mesterskab 2013		Aalborg Skyttekreds	
Prøveskud		1:	10.3	↓
		2:	10.2	↘
		3:	10.4	↘
		4:	10.3	↘
		Serie	40.0	
Total	0.0			
Gældende		1:	*10.7	→
		2:	10.4	↖
		3:	9.6	↘
		4:	8.5	↓
		5:	*10.8	↘
		6:	9.7	↘
		7:	10.4	↖
		8:	9.2	↓
		9:	8.2	↘
		10:	*10.6	↖
		Serie	93.0	
Total	93.0			
Gældende		11:	*10.5	↖
		12:	9.2	→
		13:	9.6	↘
		14:	9.7	↘
		15:	9.9	↘
		16:	9.5	↘
		17:	10.1	↘
		18:	9.2	↘
		19:	*10.5	↖
		20:	9.7	↘
		Serie	93.0	
Total	186.0			

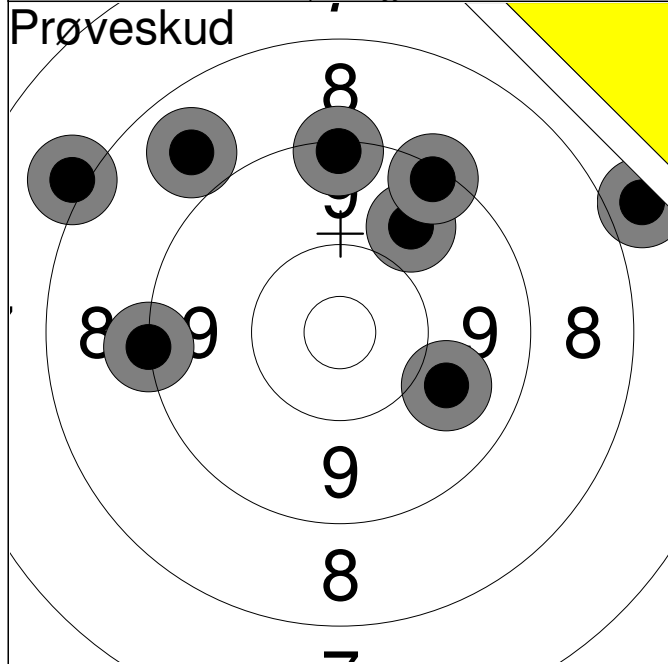

1:	9.9	→
2:	9.8	↗
3:	7.8	→
4:	9.3	↗
5:	8.0	↖
6:	9.3	↑
7:	8.8	↗
8:	9.2	←

Serie	68.0
Total	0.0

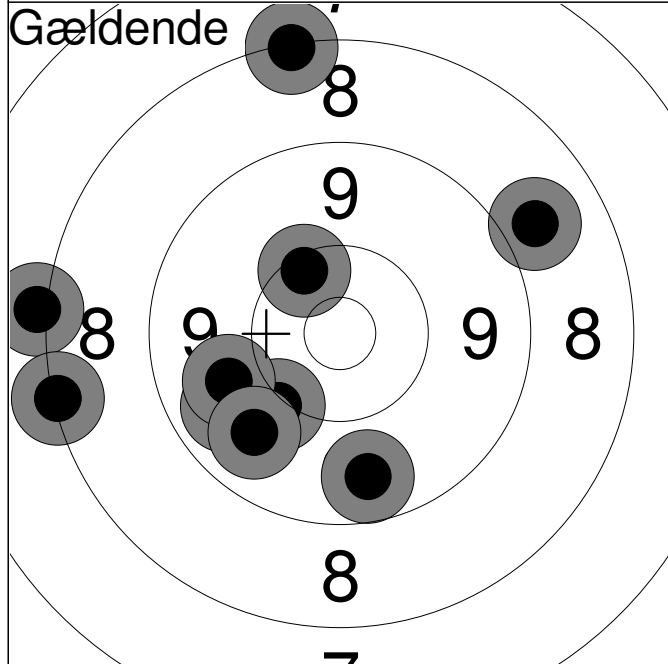

1:	8.9	↗
2:	8.2	↑
3:	8.1	←
4:	10.1	↘
5:	8.2	←
6:	9.6	↓
7:	9.7	↖
8:	9.9	←
9:	10.3	↗
10:	9.8	↘

Serie	88.0
Total	88.0

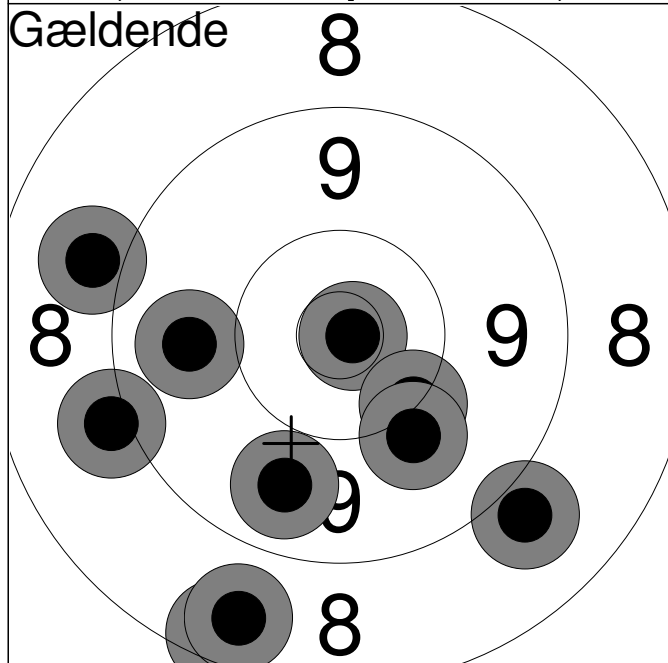

11:	8.9	←
12:	*10.9	→
13:	10.2	↘
14:	8.4	↘
15:	9.8	←
16:	9.0	←
17:	8.6	↘
18:	8.9	↘
19:	10.0	↘
20:	9.7	↘

Serie	89.0
Total	177.0

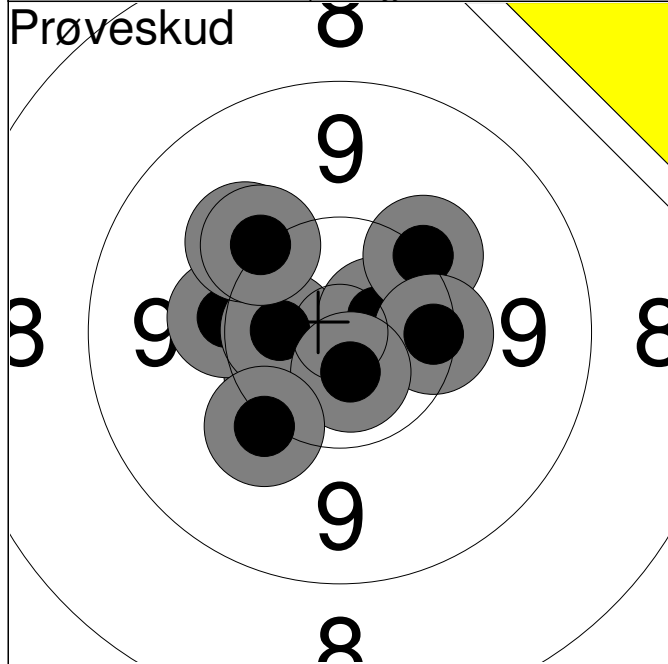

1:	*10.5	↙
2:	10.2	←
3:	*10.5	←
4:	10.1	↗
5:	*10.7	→
6:	10.1	↗
7:	10.2	↗
8:	10.3	→
9:	*10.7	↓
10:	10.1	↙
Serie		100.0
Total		0.0

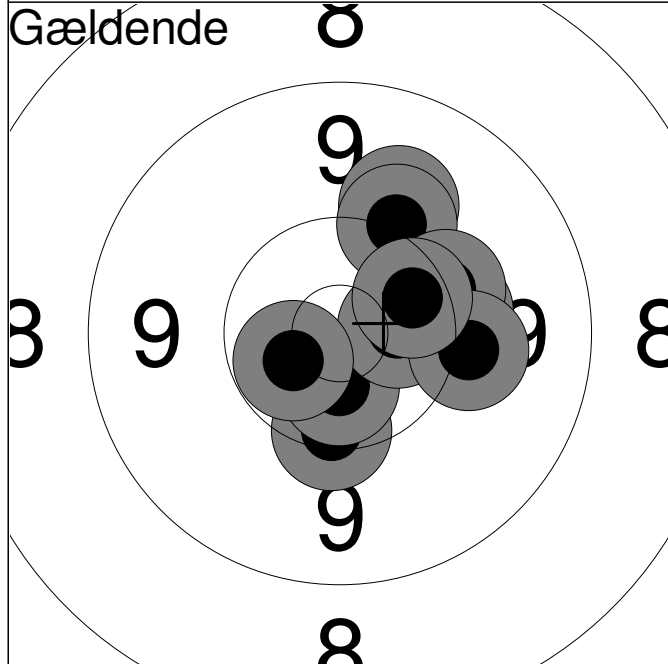

1:	10.2	→
2:	10.0	↗
3:	10.3	↓
4:	*10.6	↓
5:	*10.6	→
6:	10.1	↗
7:	10.2	→
8:	*10.6	↙
9:	10.1	→
10:	10.4	↗
Serie		100.0
Total		100.0

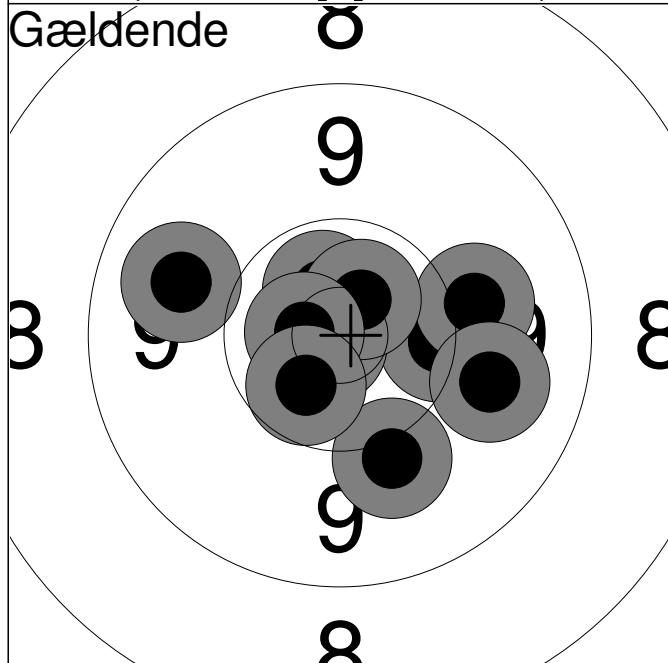

11:	9.8	←
12:	10.3	→
13:	*10.6	↗
14:	*10.8	↙
15:	10.0	→
16:	*10.7	↗
17:	10.0	↓
18:	*10.7	←
19:	*10.5	↙
20:	9.9	→
Serie		98.0
Total		198.0

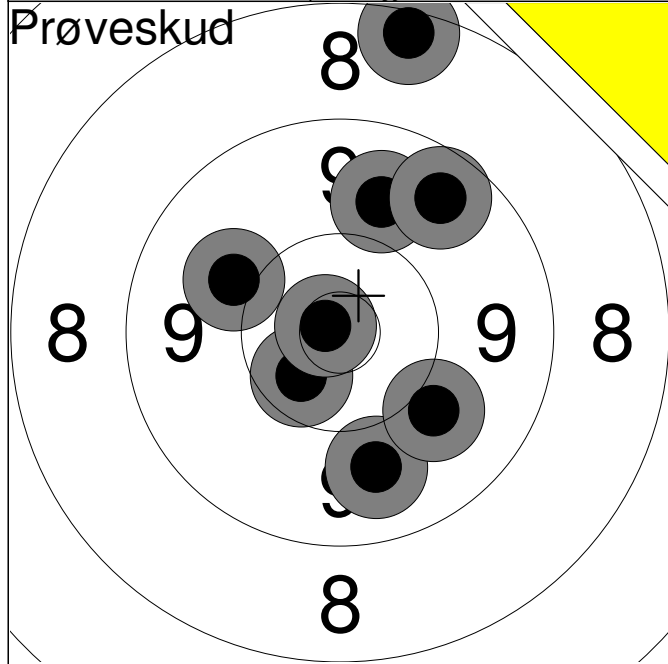

1:	8.4	↑
2:	9.8	↑
3:	9.8	↓
4:	*10.5	↓
5:	10.0	↖
6:	9.6	↗
7:	10.0	↓
8:	*10.8	↗
Serie		75.0
Total		0.0

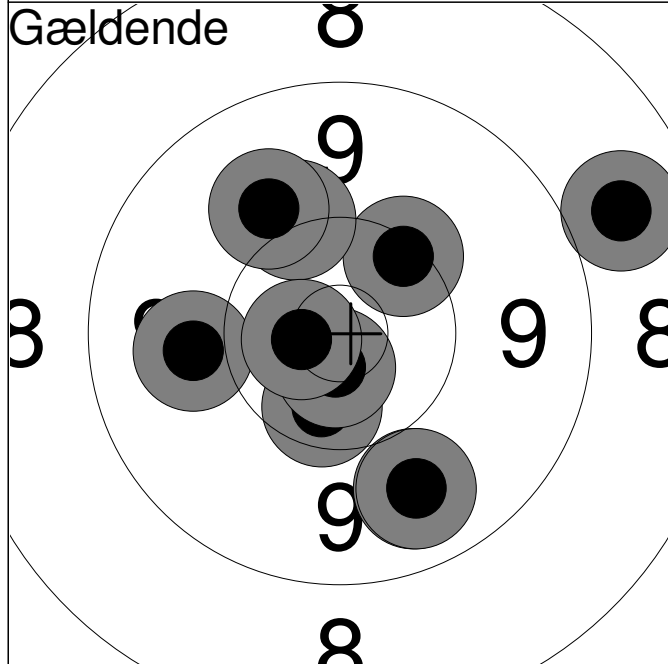

1:	10.3	↗
2:	9.9	←
3:	9.8	↓
4:	*10.4	↓
5:	*10.7	↓
6:	10.1	↗
7:	9.8	↓
8:	10.0	↗
9:	*10.7	←
10:	8.8	↗
Serie		95.0
Total		95.0

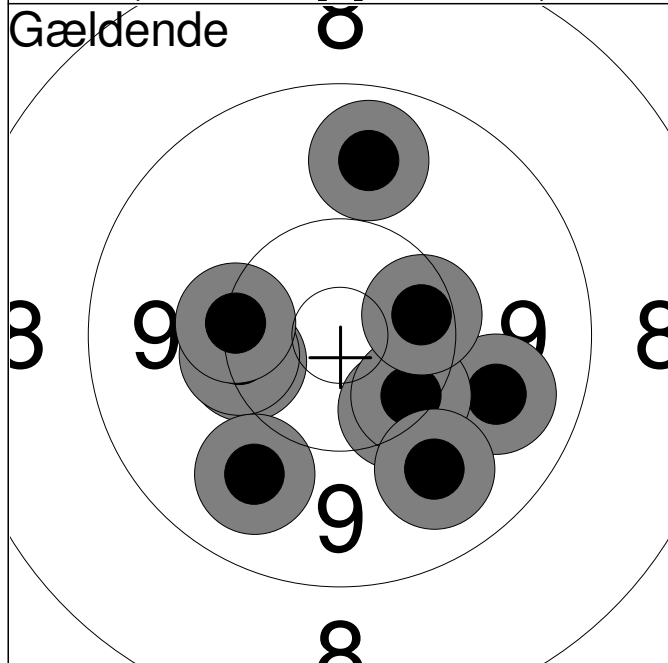

11:	10.3	←
12:	10.3	↓
13:	9.8	↘
14:	10.3	↓
15:	9.8	↓
16:	10.4	↗
17:	10.2	←
18:	9.7	↑
19:	10.2	←
20:	9.8	↘
Serie		96.0
Total		191.0

Hold 60	Skive 8	Brian Jensen
-------------------	-------------------	---------------------

50m	Vilsted Skf.	MÅ1
-----	--------------	-----

	Nordjysk Mesterskab 2013	Aalborg Skyttekreds
--	--------------------------	---------------------

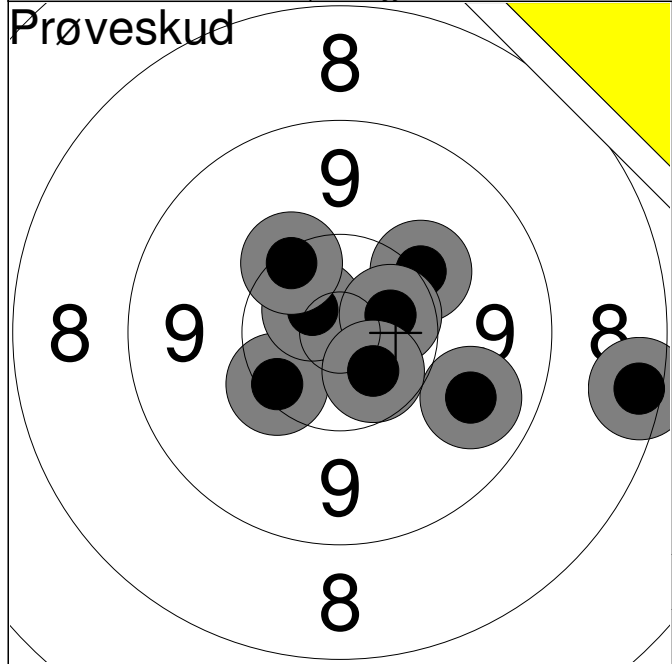

1:	8.4	→
2:	10.3	↙
3:	*10.7	↗
4:	10.3	↗
5:	10.1	↗
6:	*10.5	→
7:	9.8	↘
8:	*10.5	↘
Serie		77.0
Total		0.0

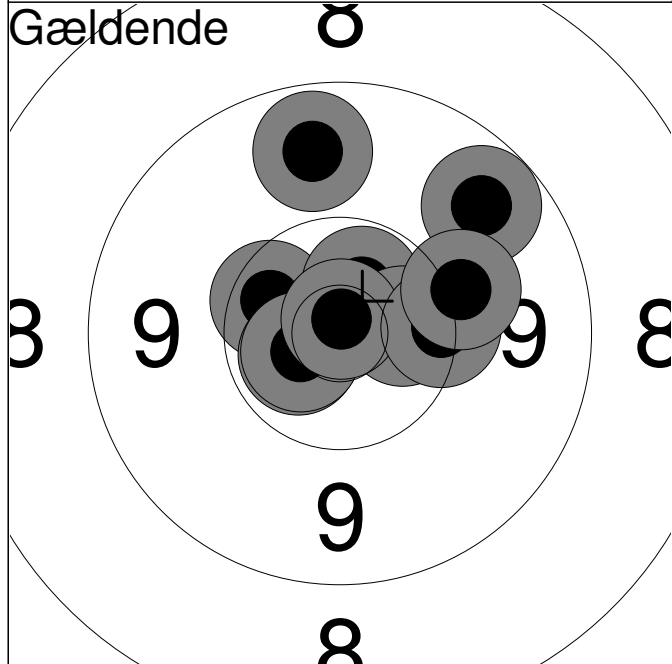

1:	*10.4	↖
2:	*10.6	↗
3:	*10.5	→
4:	*10.6	↙
5:	*10.7	↙
6:	*10.9	↑
7:	10.3	→
8:	9.6	↗
9:	10.1	→
10:	9.7	↑
Serie		98.0
Total		98.0

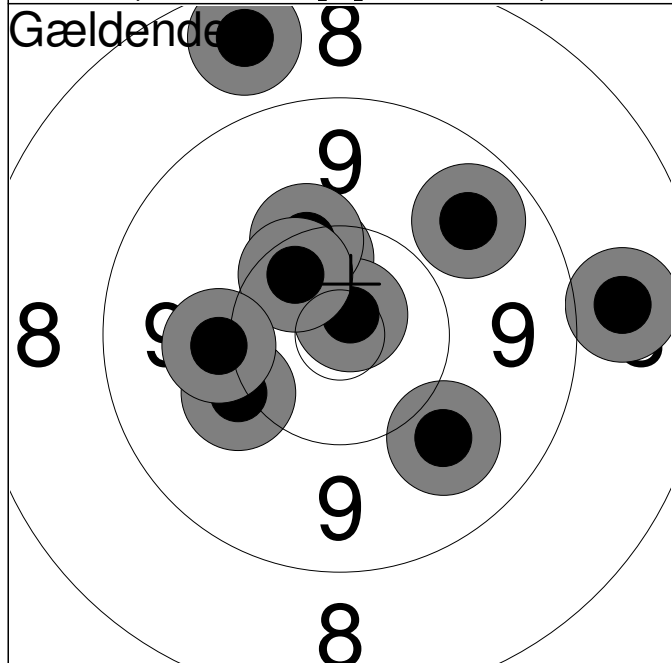

11:	9.7	↗
12:	9.9	↘
13:	8.6	↑
14:	10.4	↑
15:	*10.8	↗
16:	10.2	↑
17:	10.4	↗
18:	10.1	↙
19:	10.1	←
20:	8.8	→
Serie		94.0
Total		192.0

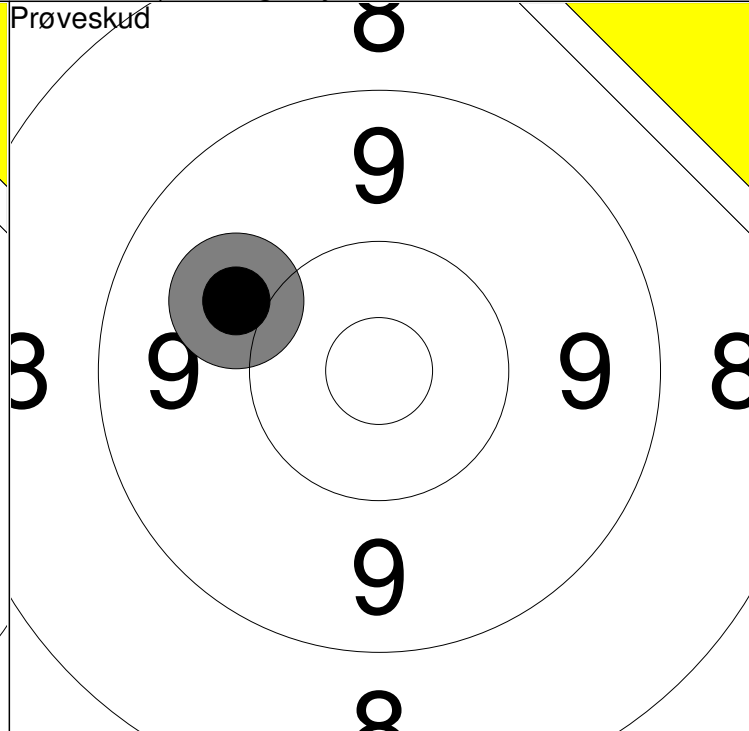
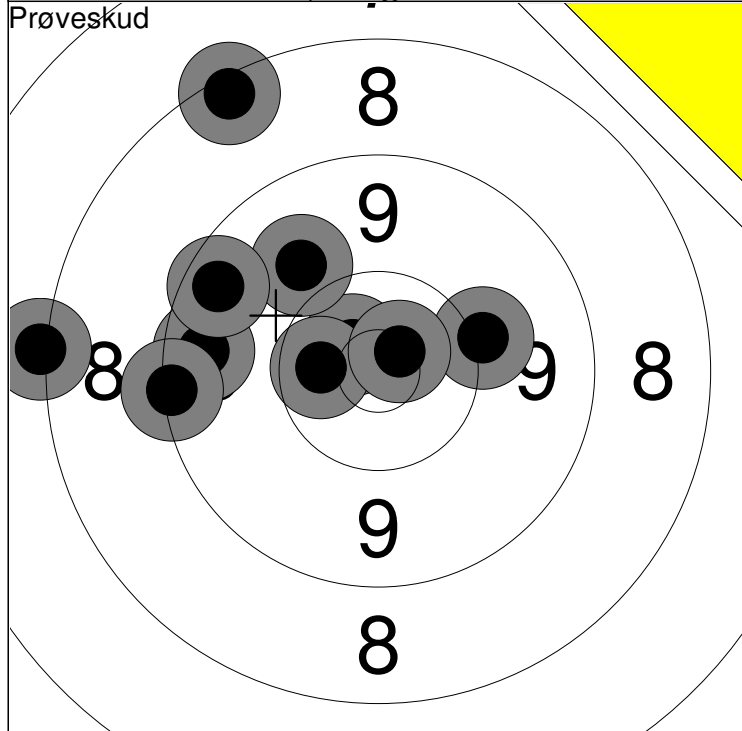

1: 8.3 ↗	6: 9.3 ←	Serie 92
2: *10.7 ↘	7: 9.5 ←	
3: 8.1 ←	8: 10.1 →	Total 0
4: 9.9 ↗	9: *10.5 ←	
5: 9.5 ←	10: *10.7 ↗	

11: 10.0 ↖	Serie 10
	Total 0

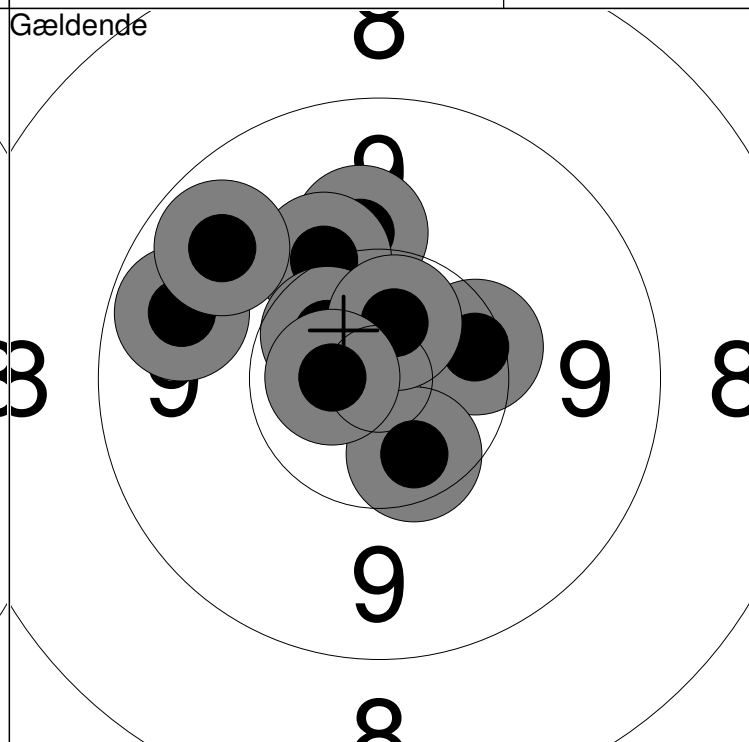
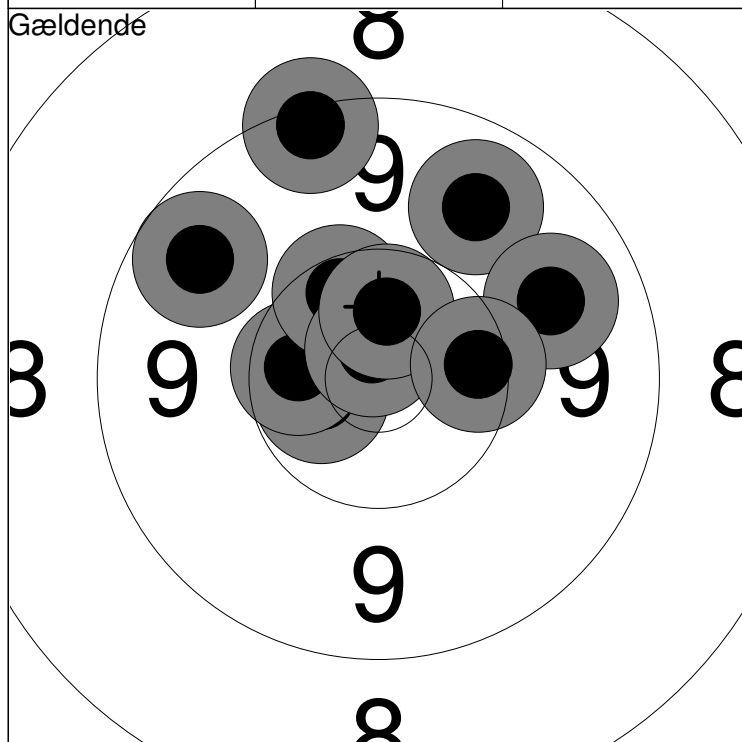

1: *10.6 ←	6: *10.8 ↑	Serie 96
2: 9.7 ↗	7: 9.8 →	
3: 9.6 ←	8: *10.5 ↑	Total 96
4: *10.5 ←	9: 9.3 ↑	
5: 10.4 ↗	10: 10.3 →	

11: 10.1 ↑	16: 10.2 ↗	Serie 98
12: 10.3 →	17: *10.5 ↘	
13: 9.7 ←	18: *10.6 ↑	Total 194
14: *10.4 ↓	19: 9.7 ↖	
15: *10.6 ↘	20: *10.7 ←	

Hold 60	Skive 10	Morten Aagaard Christensen	
-------------------	--------------------	-----------------------------------	--

50m	Vilsted Skf.	MÅ1
-----	--------------	-----

	Nordjysk Mesterskab 2013	Aalborg Skyttekreds
--	--------------------------	---------------------

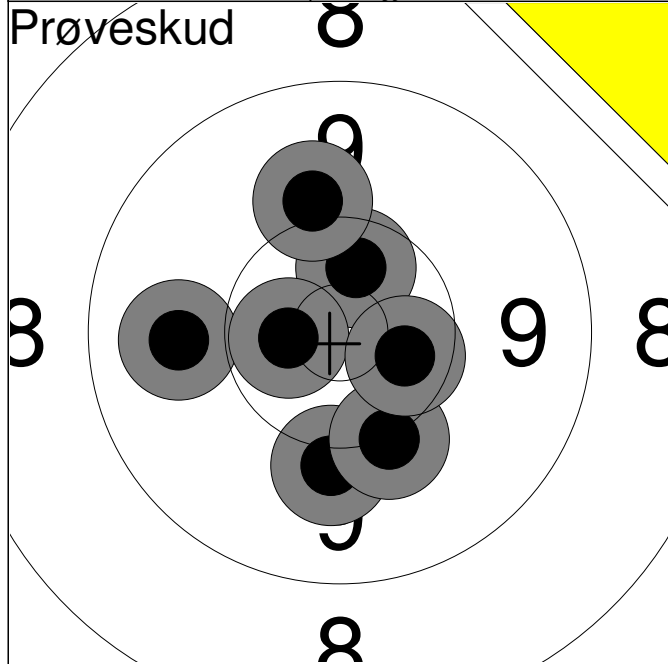

1:	10.0	↓
2:	*10.5	↑
3:	10.1	↓
4:	10.0	↑
5:	9.8	←
6:	*10.6	←
7:	*10.5	→
Serie		69.0
Total		0.0

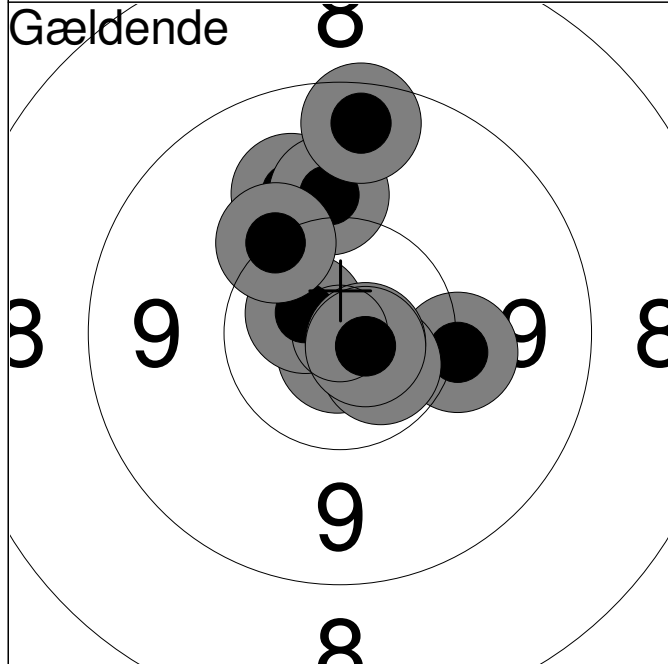

1:	10.1	→
2:	9.9	↑
3:	*10.8	↓
4:	10.0	↑
5:	*10.7	↗
6:	*10.6	↓
7:	*10.8	→
8:	*10.8	↓
9:	10.2	↗
10:	9.5	↑
Serie		98.0
Total		98.0

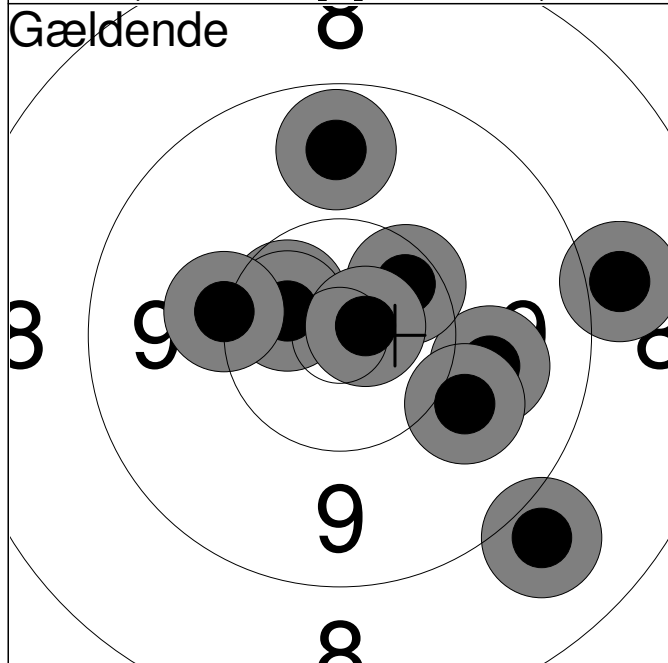

11:	9.9	→
12:	*10.5	↗
13:	*10.6	↖
14:	10.1	←
15:	9.7	↑
16:	10.4	↗
17:	*10.8	→
18:	8.9	→
19:	10.0	↓
20:	8.9	↓
Serie		94.0
Total		192.0

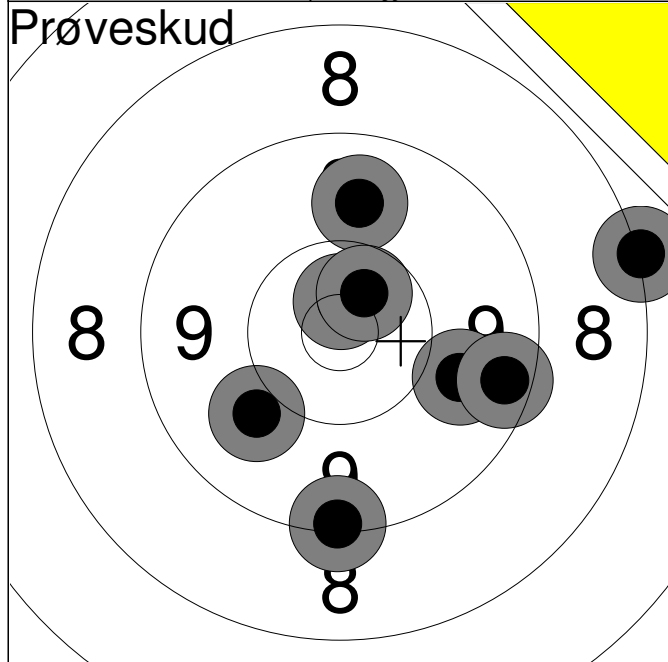

1:	9.8	→
2:	9.4	→
3:	*10.7	↑
4:	9.8	↑
5:	9.3	↓
6:	10.0	↙
7:	8.1	→
8:	*10.6	↗
Serie		74.0
Total		0.0

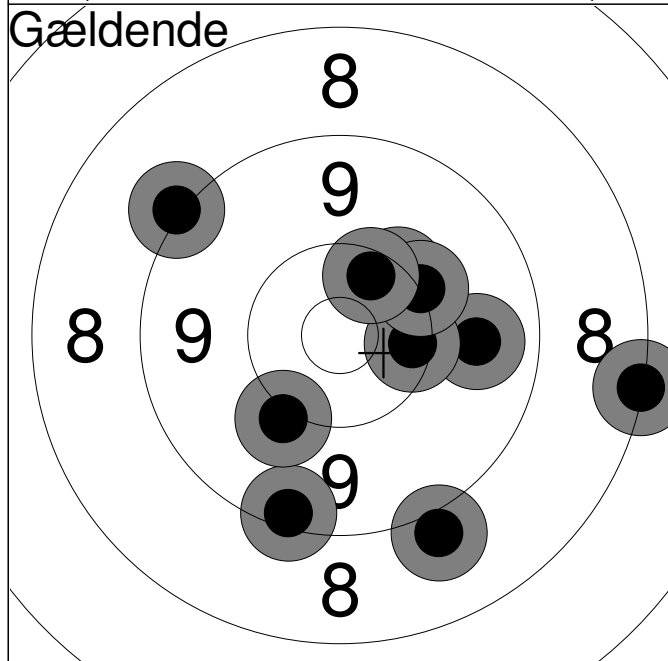

1:	10.2	↗
2:	9.1	↖
3:	9.8	→
4:	9.3	↓
5:	10.1	↙
6:	10.3	→
7:	8.2	→
8:	10.2	↗
9:	10.4	↗
10:	9.0	↓
Serie		94.0
Total		94.0

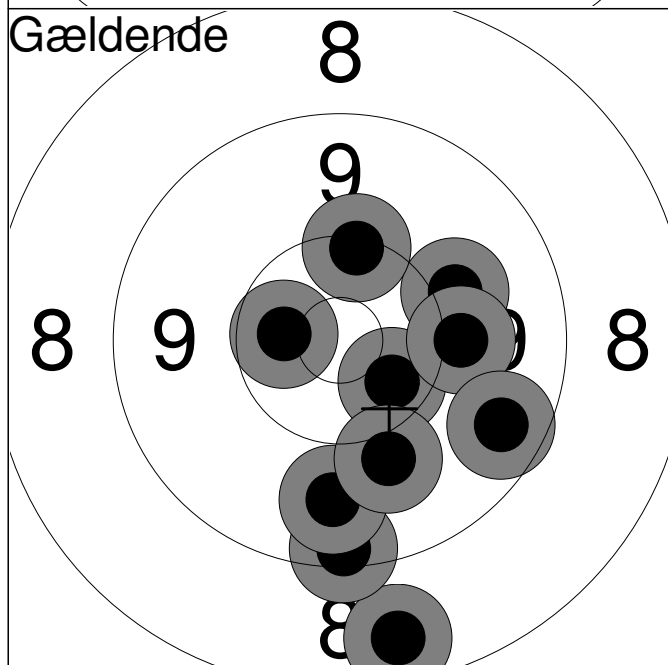

11:	10.0	→
12:	*10.5	←
13:	8.5	↓
14:	*10.4	↘
15:	10.0	→
16:	10.2	↑
17:	9.3	↓
18:	9.7	↓
19:	10.0	↓
20:	9.5	↘
Serie		95.0
Total		189.0

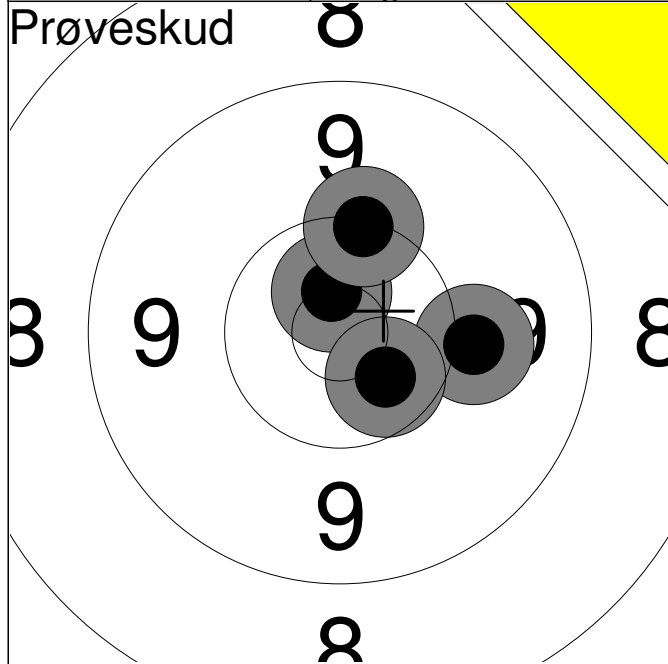

1:	10.0	→
2:	*10.7	↑
3:	*10.5	↘
4:	10.2	↑
Serie		40.0
Total		0.0

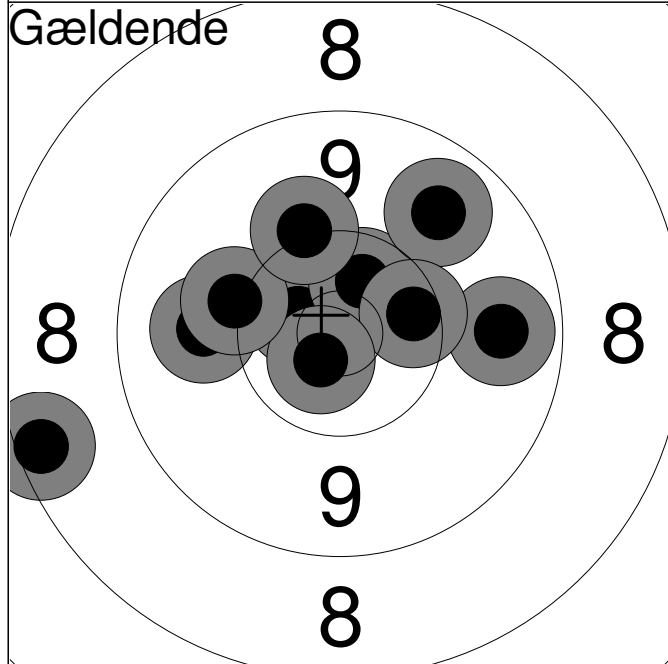

1:	9.9	←
2:	*10.6	↖
3:	8.4	←
4:	9.7	→
5:	*10.5	↑
6:	9.7	↗
7:	10.4	→
8:	*10.7	↘
9:	10.1	←
10:	10.1	↑
Serie		95.0
Total		95.0

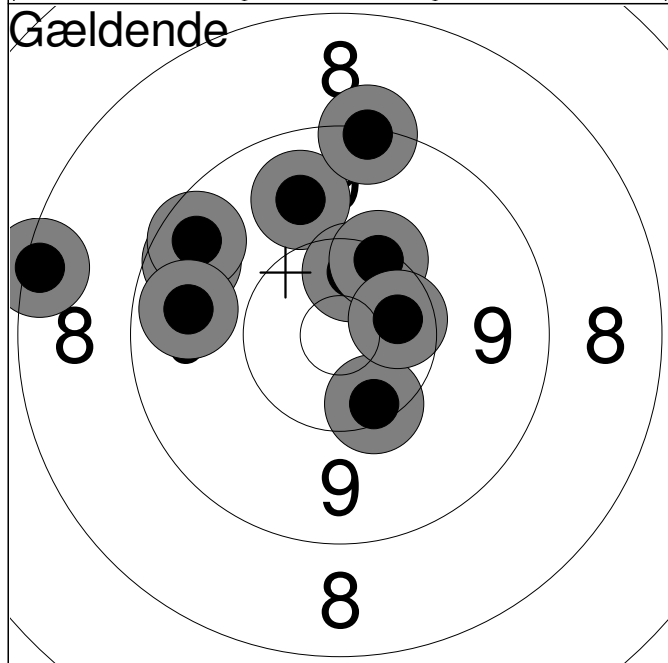

11:	9.8	↑
12:	9.2	↑
13:	9.6	↖
14:	*10.4	↑
15:	9.5	↖
16:	9.7	←
17:	8.3	←
18:	10.3	↗
19:	10.3	↘
20:	*10.5	→
Serie		93.0
Total		188.0

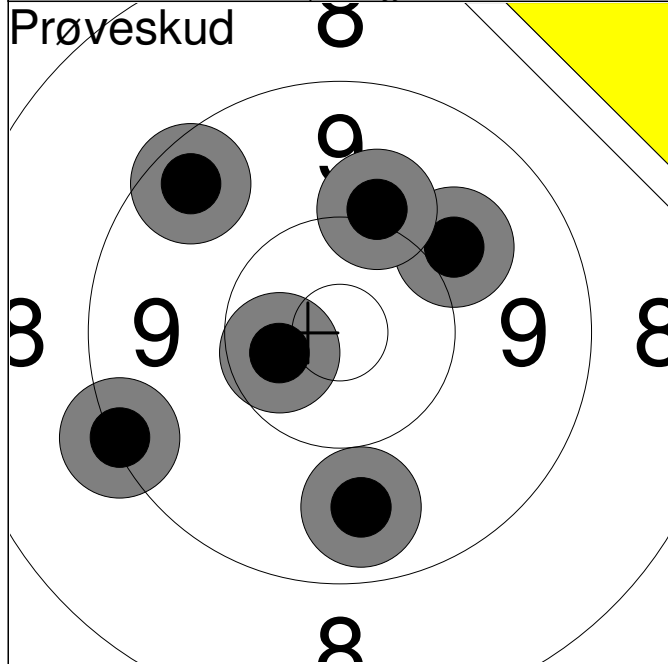

1:	9.5	↖
2:	9.7	↓
3:	9.2	↙
4:	*10.5	↙
5:	10.0	↗
6:	10.1	↑
Serie		57.0
Total		0.0

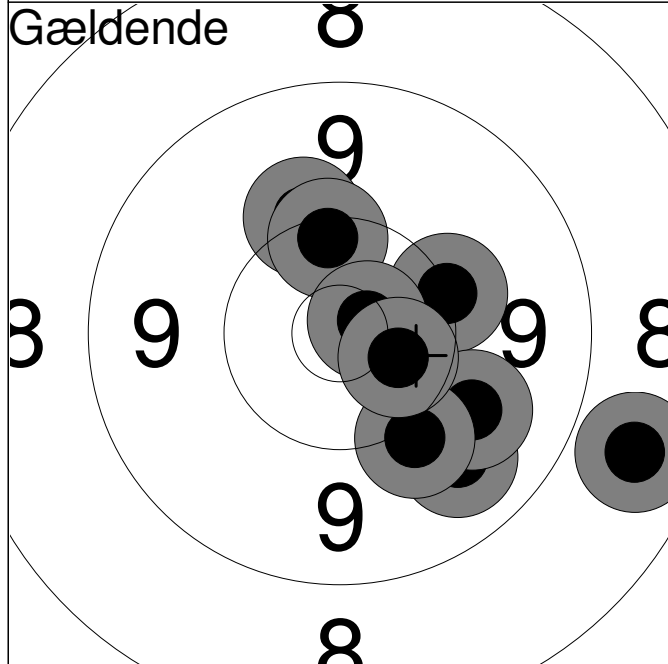

1:	10.2	→
2:	10.1	↘
3:	9.8	↘
4:	10.1	↑
5:	8.7	→
6:	10.3	↑
7:	9.9	↘
8:	10.1	↘
9:	*10.7	→
10:	*10.5	→
Serie		96.0
Total		96.0

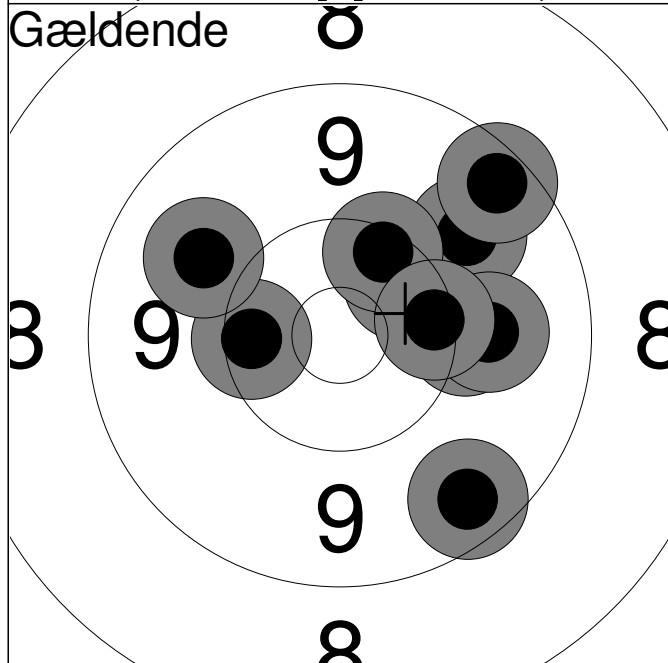

11:	10.4	↗
12:	9.8	↗
13:	9.5	↘
14:	9.4	↗
15:	10.1	→
16:	10.3	↑
17:	9.9	→
18:	10.3	←
19:	10.3	→
20:	9.9	↖
Serie		95.0
Total		191.0

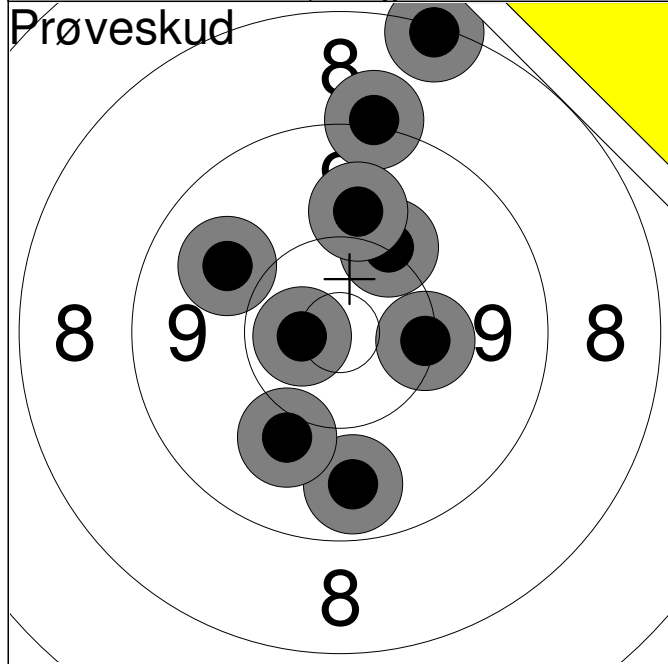

1:	8.2	↑
2:	*10.6	←
3:	9.7	↓
4:	10.0	↙
5:	10.2	→
6:	10.1	↗
7:	9.1	↑
8:	9.9	↑
9:	9.9	↖
Serie		84.0
Total		0.0

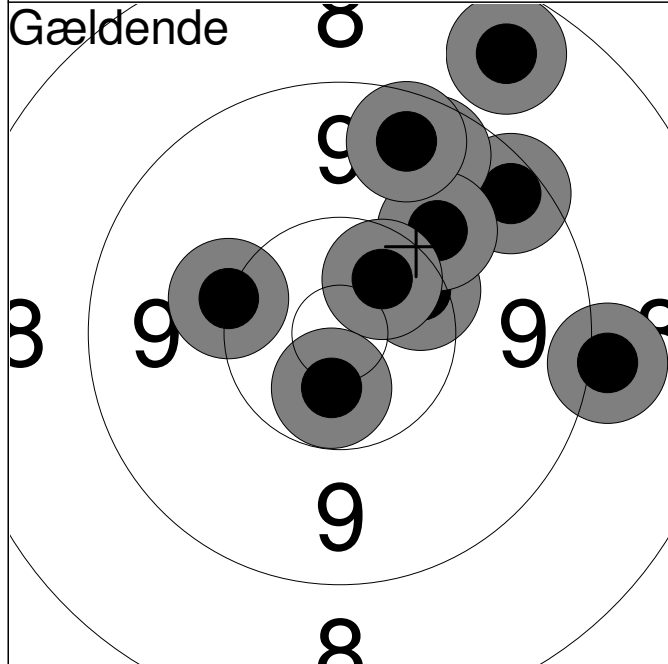

1:	9.4	↗
2:	9.0	→
3:	10.3	↗
4:	9.6	↑
5:	10.0	↗
6:	8.6	↑
7:	10.2	←
8:	*10.5	↗
9:	9.5	↑
10:	*10.6	↓
Serie		94.0
Total		94.0

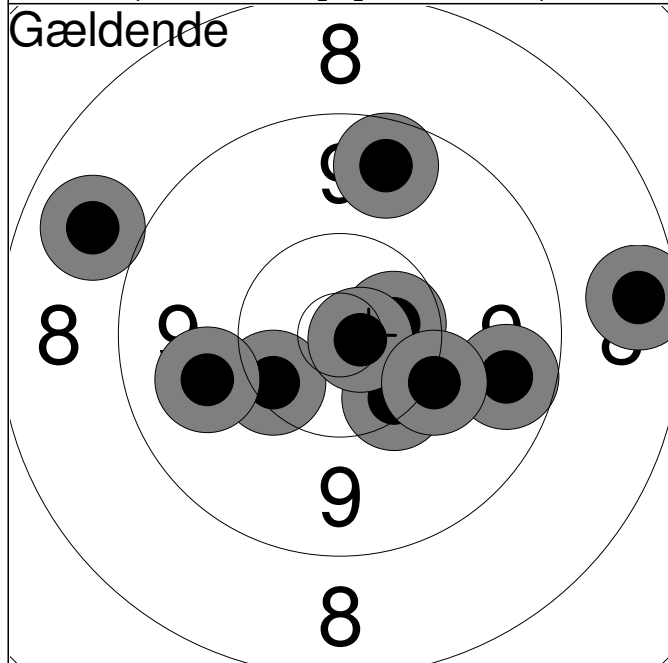

11:	10.3	↘
12:	8.5	→
13:	*10.5	→
14:	10.3	↙
15:	9.6	→
16:	8.8	↗
17:	*10.8	→
18:	9.9	←
19:	9.6	↑
20:	10.1	↘
Serie		93.0
Total		187.0

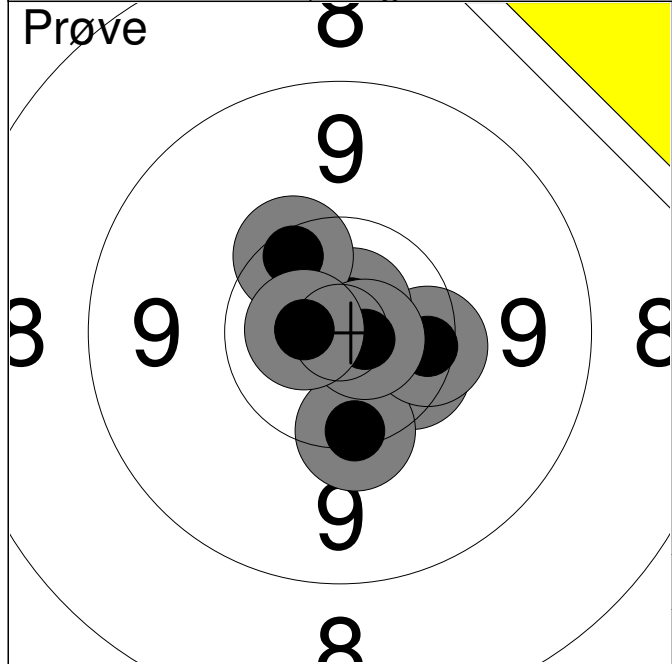

1:	10.4	↘
2:	10.3	↓
3:	10.3	↗
4:	*10.8	↗
5:	10.3	↗
6:	*10.8	↘
7:	*10.7	↖
Serie		73.6
Total		398.0

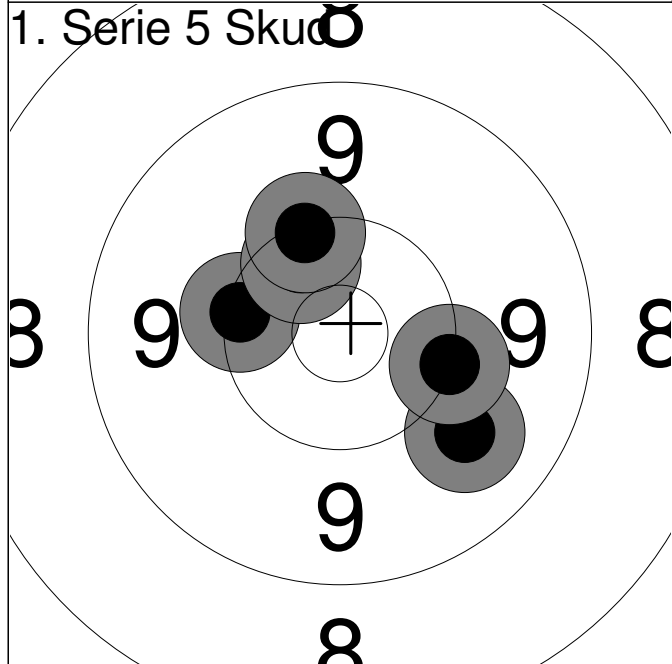

1:	10.3	↖
2:	10.4	↗
3:	10.2	↗
4:	9.9	↓
5:	10.2	↘
Serie		51.0
Total		449.0



1:	9.2	↓
2:	*10.7	↖
3:	9.9	↖
4:	10.4	↗
5:	10.2	↘
Serie		50.4
Total		499.4

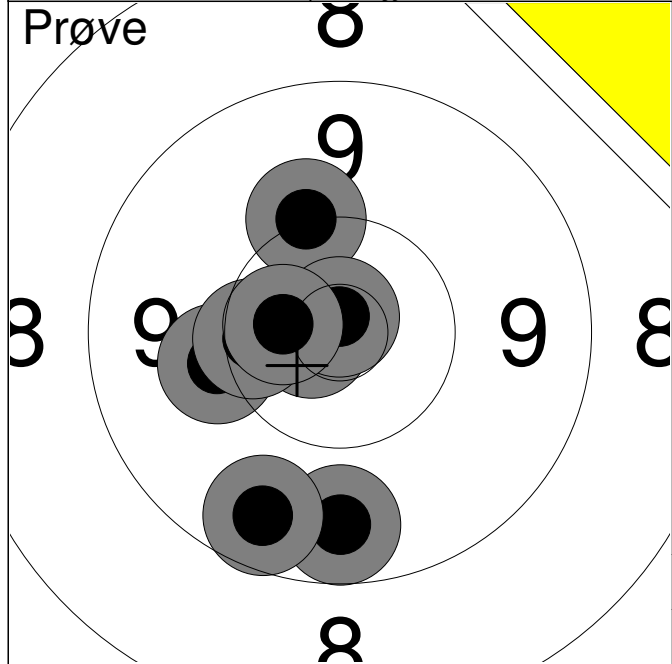

1:	9.6	↓
2:	9.6	↓
3:	10.1	←
4:	10.1	↑
5:	*10.8	←
6:	10.4	←
7:	*10.8	↑
8:	*10.6	←
Serie		82.0
Total		397.0

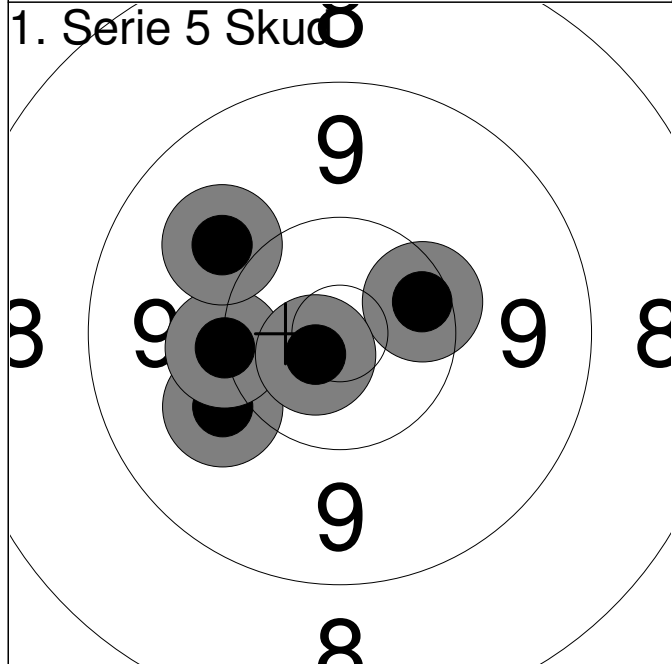

1:	10.0	↙
2:	10.2	←
3:	9.9	↘
4:	10.3	→
5:	*10.7	↙
Serie		51.1
Total		448.1



1:	10.3	↙
2:	*10.7	←
3:	10.3	↗
4:	*10.5	↗
5:	*10.7	↙
Serie		52.5
Total		500.6

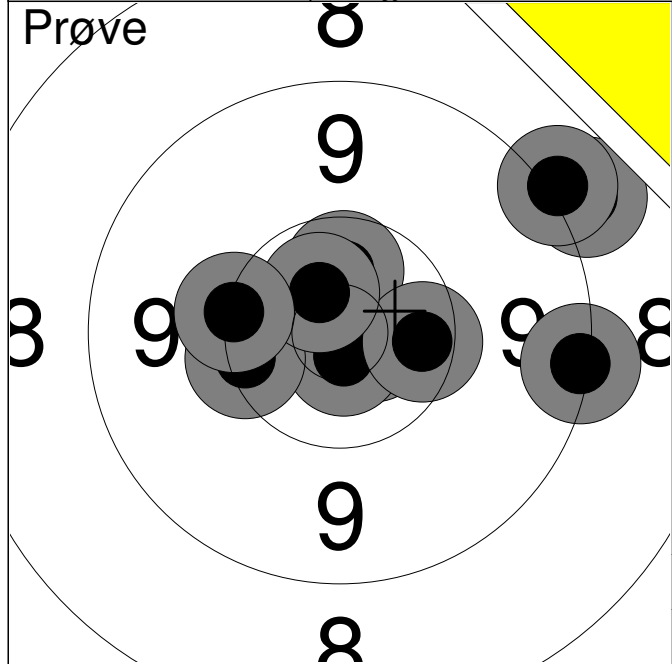

1:	9.0	↗
2:	9.2	→
3:	9.1	↗
4:	*10.7	→
5:	*10.5	↑
6:	*10.8	↓
7:	10.3	←
8:	10.4	→
9:	*10.6	↗
10:	10.2	←
Serie		100.8
Total		397.0

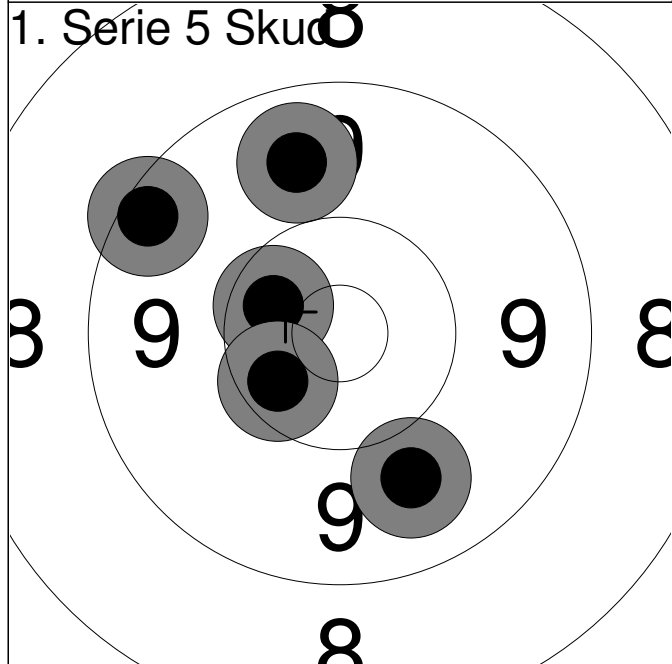

1:	9.4	↖
2:	*10.5	↖
3:	9.7	↑
4:	*10.4	↖
5:	9.8	↓
Serie		49.8
Total		446.8

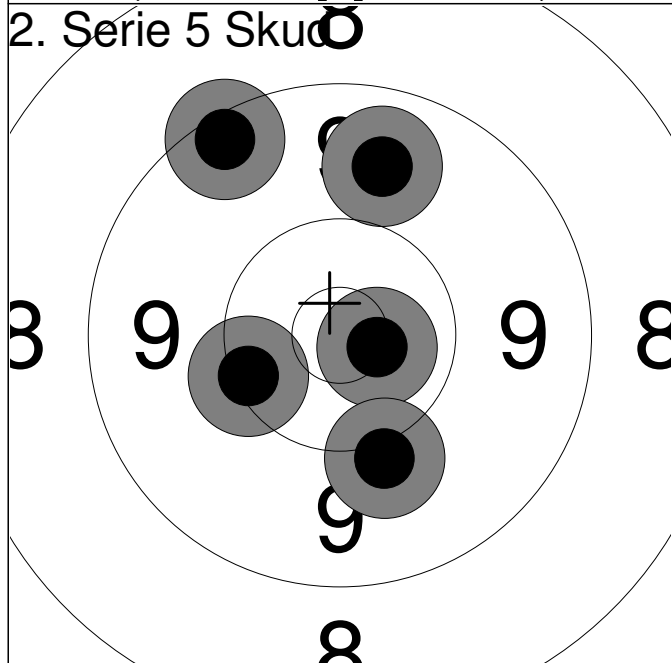

1:	10.3	←
2:	*10.7	→
3:	10.1	↓
4:	9.7	↑
5:	9.4	↗
Serie		50.2
Total		497.0

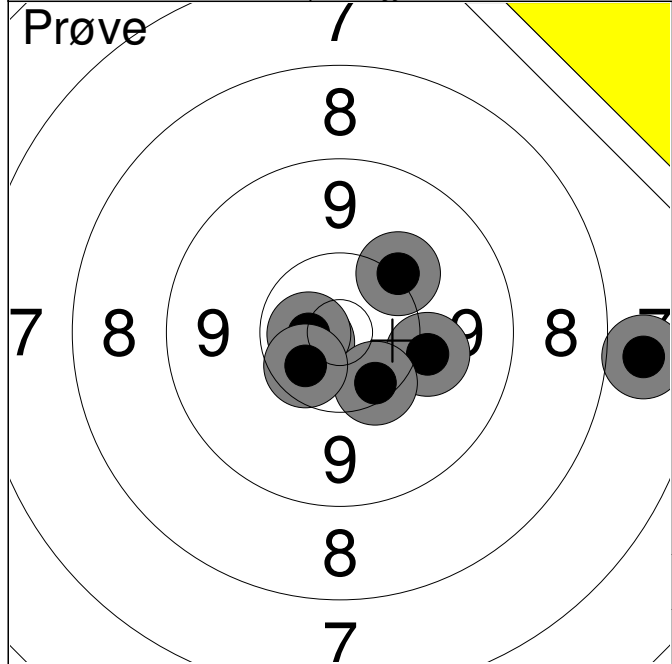

1:	7.8	→
2:	10.1	→
3:	*10.7	←
4:	*10.6	←
5:	10.1	↗
6:	10.3	↘
7:	*10.5	↙
Serie		70.1
Total		397.0

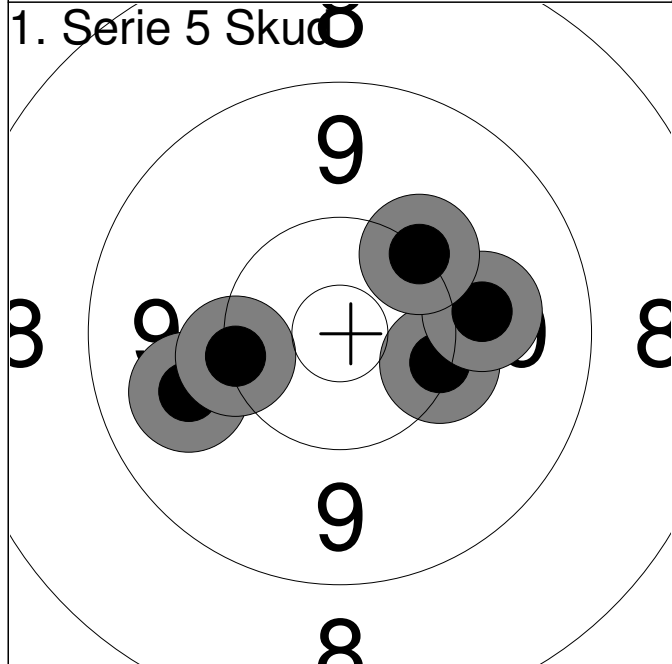

1:	9.8	←
2:	10.2	←
3:	10.2	→
4:	10.0	→
5:	10.2	↗
Serie		50.4
Total		447.4



1:	9.4	↗
2:	10.1	↑
3:	10.2	↘
4:	*10.6	↗
5:	*10.5	↘
Serie		50.8
Total		498.2

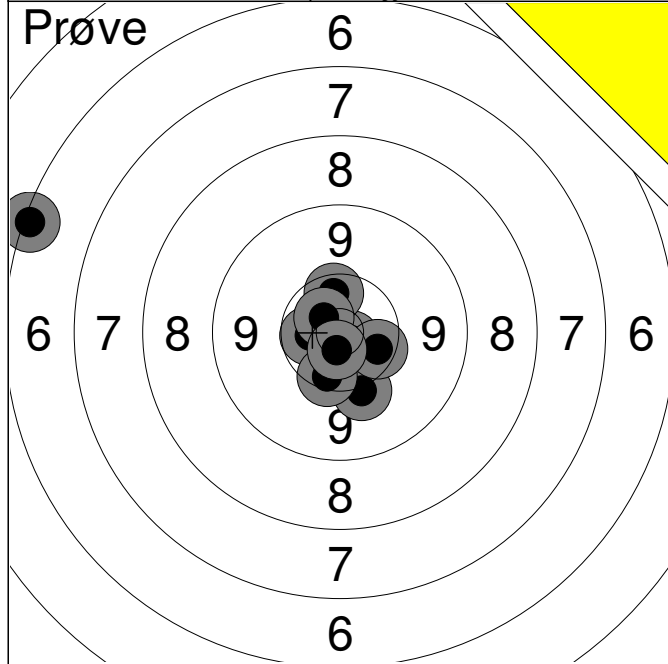

1:	6.3	↖
2:	*10.7	↗
3:	10.1	↘
4:	*10.8	↘
5:	10.4	↘
6:	*10.5	↖
7:	10.3	↘
8:	10.4	↗
9:	*10.7	↗
10:	*10.7	↘
Serie		100.9
Total		396.0

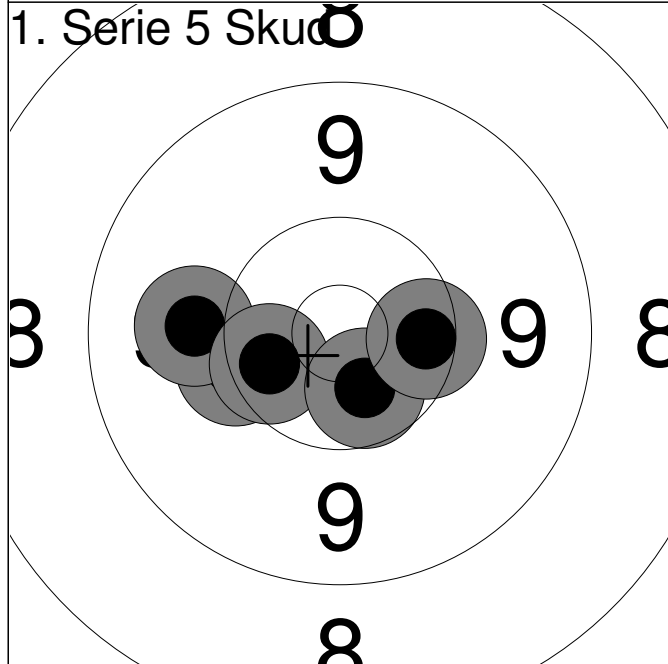

1:	10.2	↖
2:	10.0	↖
3:	*10.4	↖
4:	*10.5	↘
5:	10.4	→
Serie		51.5
Total		447.5



1:	*10.5	↘
2:	10.3	↘
3:	10.4	↘
4:	*10.8	↖
5:	*10.8	↘
Serie		52.8
Total		500.3

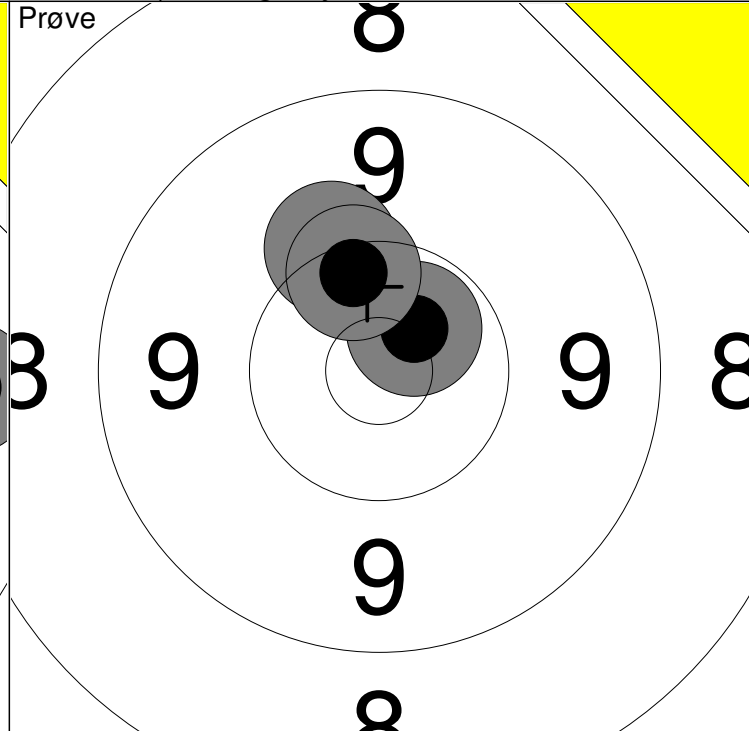
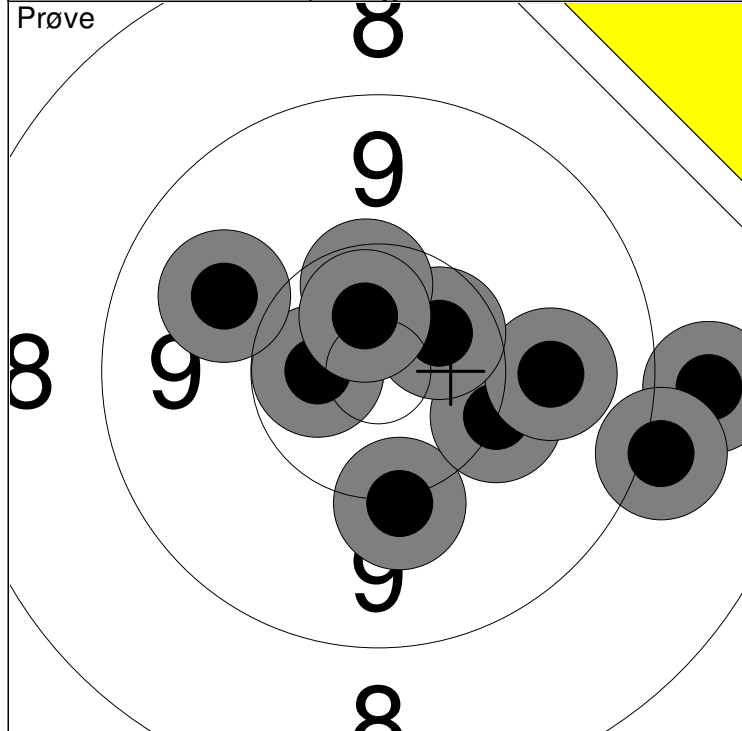

1: 8.8 →	6: *10.5 ↗	Serie	100.1
2: 9.1 →	7: *10.6 ↙		
3: 10.1 ↓	8: 9.9 ↖	Total	398.0
4: 10.2 →	9: 10.4 ↑		
5: 9.9 →	10: *10.6 ↑		

11: 10.1 ↖	Serie	31.0
12: *10.6 ↗		
13: 10.3 ↖	Total	398.0

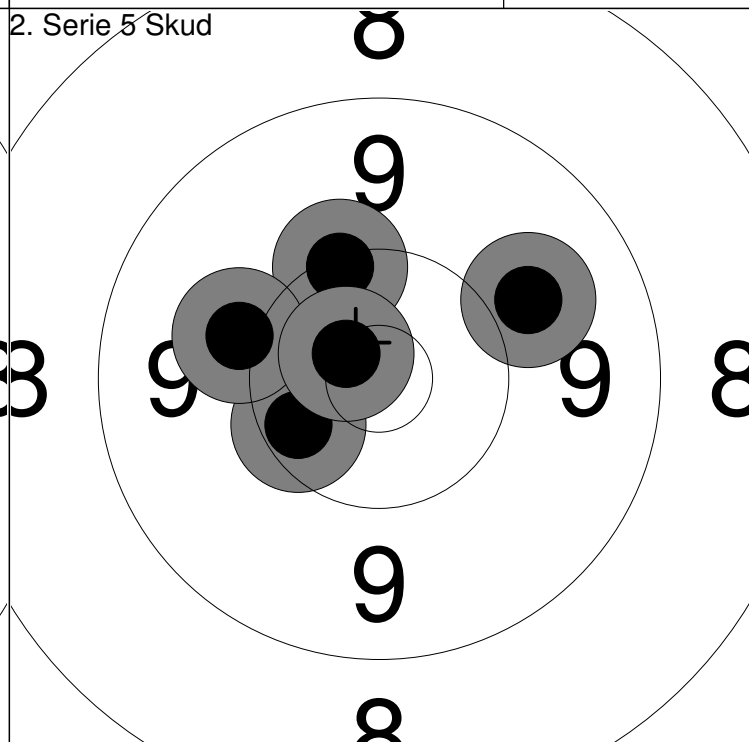
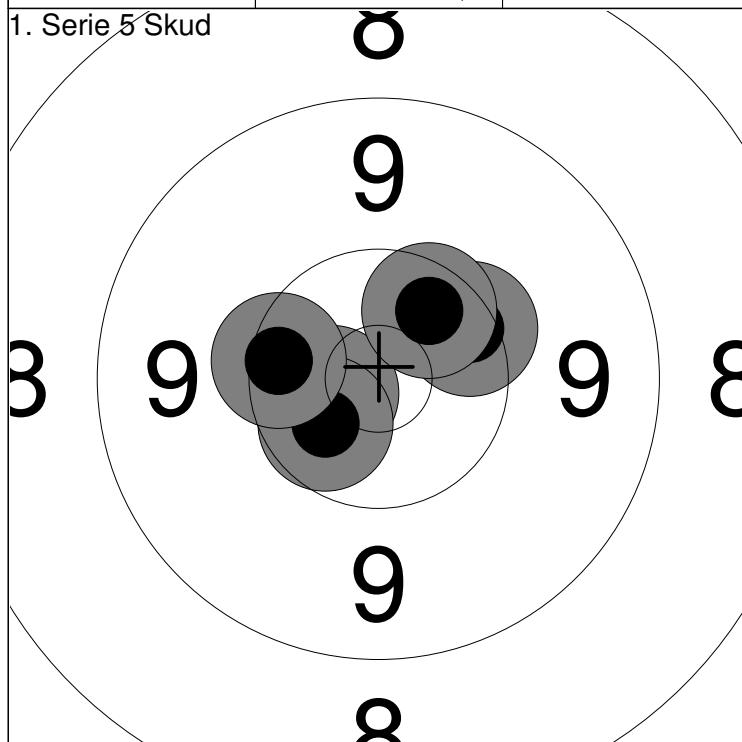

1: *10.6 ↙	Serie	52.1
2: *10.5 ↙		
3: 10.3 ↗	Total	450.1
4: *10.4 ↗		
5: 10.3 ↖		

1: 10.2 ↖	Serie	51.3
2: 10.4 ↙		
3: 10.1 ↖	Total	501.4
4: *10.7 ↙		
5: 9.9 ↗		

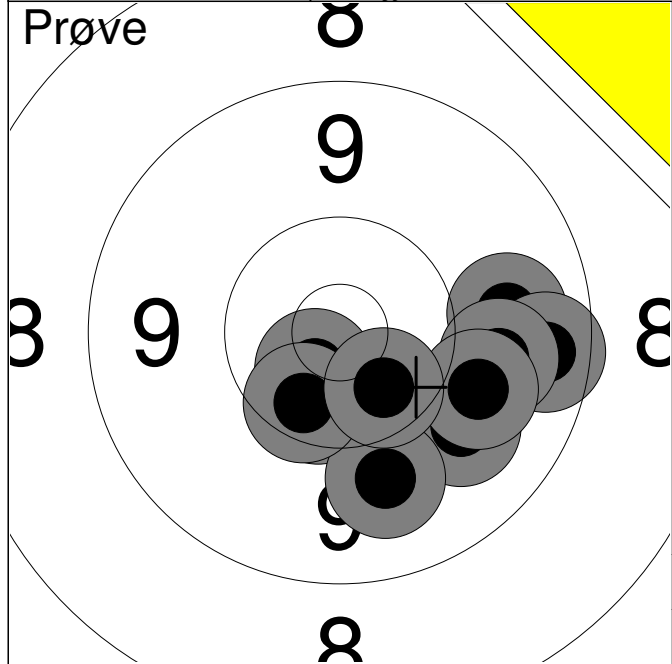

1:	9.8	→
2:	9.9	↘
3:	9.5	→
4:	9.8	→
5:	9.9	↘
6:	*10.4	↘
7:	9.9	↘
8:	*10.7	↘
9:	10.4	↘
10:	*10.5	↘
Serie		100.8
Total		396.0

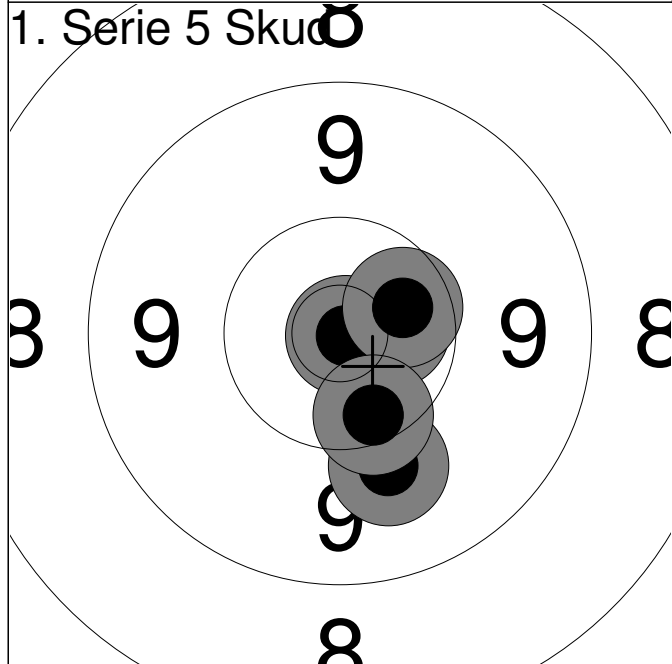

1:	*10.6	→
2:	10.0	↘
3:	*10.9	→
4:	*10.5	→
5:	10.3	↘
Serie		52.3
Total		448.3



1:	9.4	↙
2:	*10.7	↓
3:	10.0	↘
4:	9.7	←
5:	9.9	↙
Serie		49.7
Total		498.0

Hold 68	Skive 4	Emil L. Nielsen	
-------------------	-------------------	------------------------	--

50m	Vester Hassing Skf.	F5FB
-----	---------------------	------

Nordjysk Mesterskab 2013	Aalborg Skyttekreds
--------------------------	---------------------

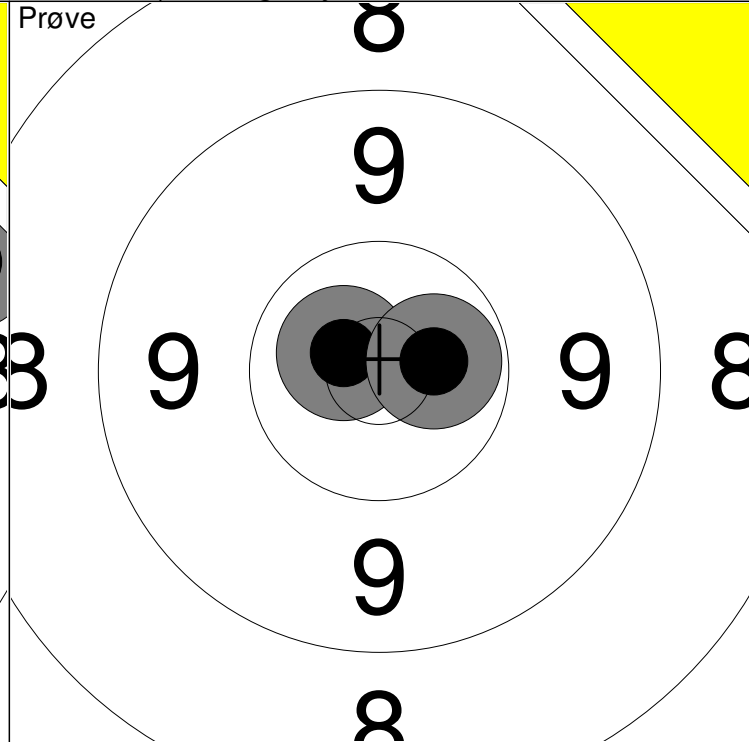
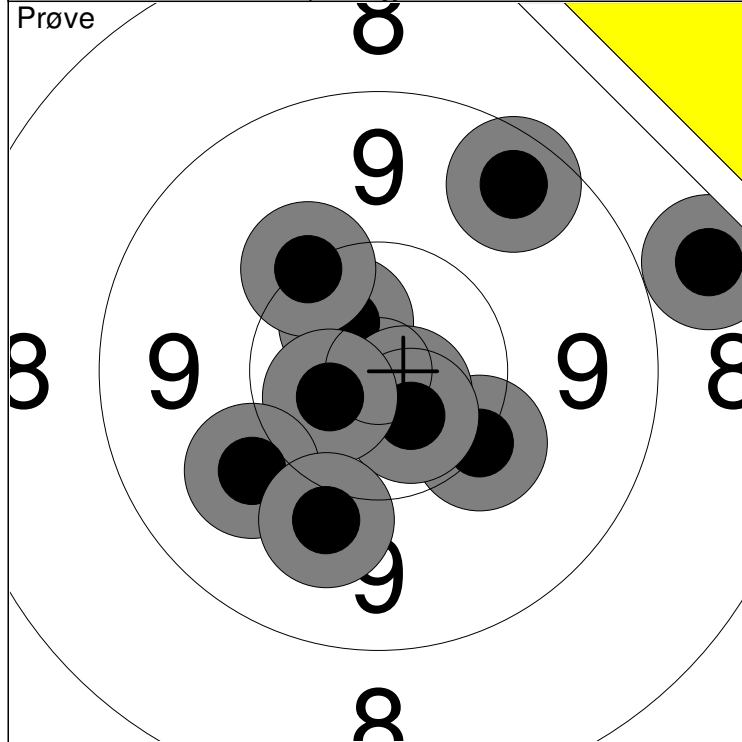

1: 8.7 →	6: *10.7 ↘	Serie 101.1
2: 9.5 ↗	7: *10.6 ↘	
3: *10.6 ↖	8: *10.6 ↙	Total 396.0
4: 10.2 ↗	9: 10.0 ↙	
5: 10.2 ↘	10: 10.0 ↘	

11: *10.7 ↖	Serie 21.3
12: *10.6 →	
Total 396.0	

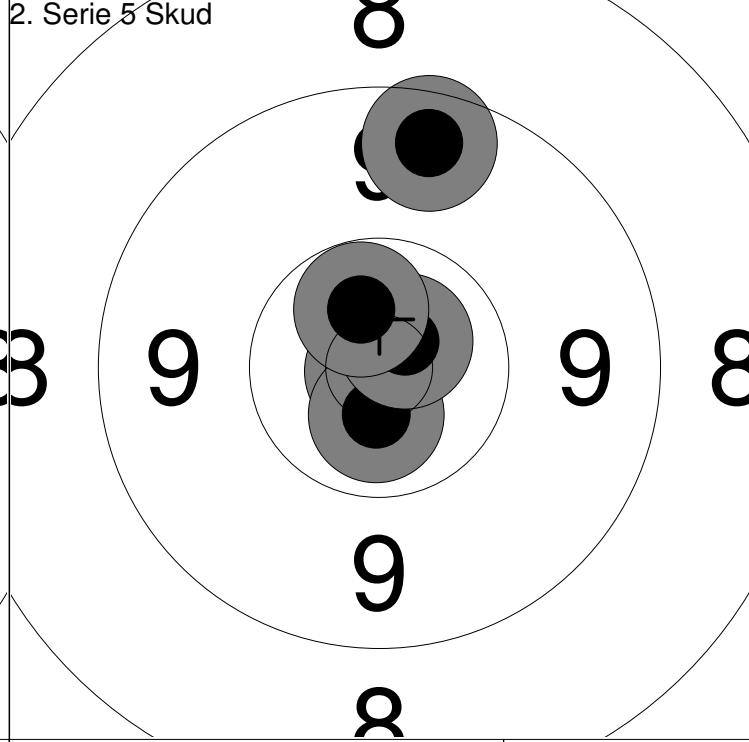
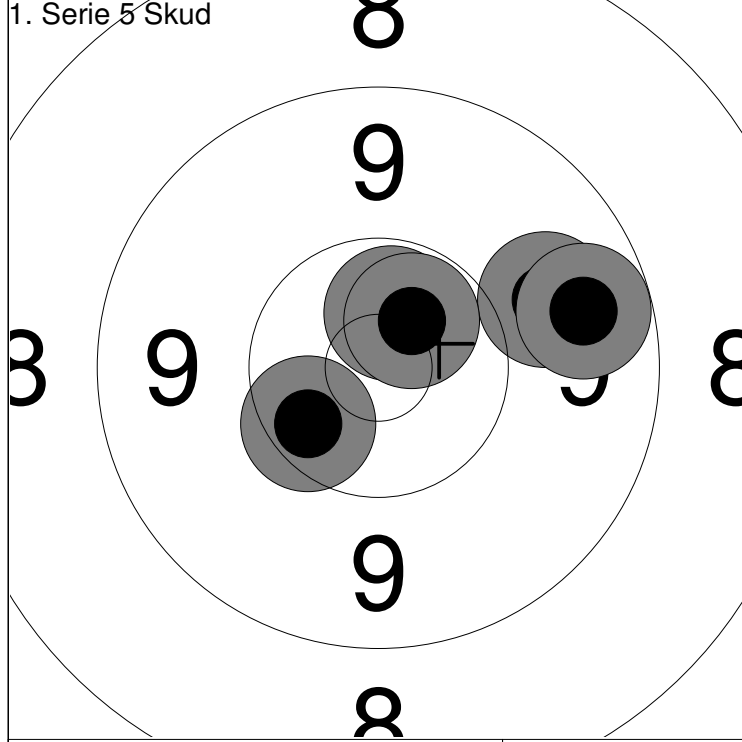

1: 9.8 →	Serie 51.0
2: 9.6 →	
3: *10.6 ↑	Total 447.0
4: 10.4 ↙	
5: *10.6 ↗	

1: 9.5 ↑	Serie 52.4
2: *10.9 ↙	
3: *10.7 ↘	Total 499.4
4: *10.7 ↗	
5: *10.6 ↗	

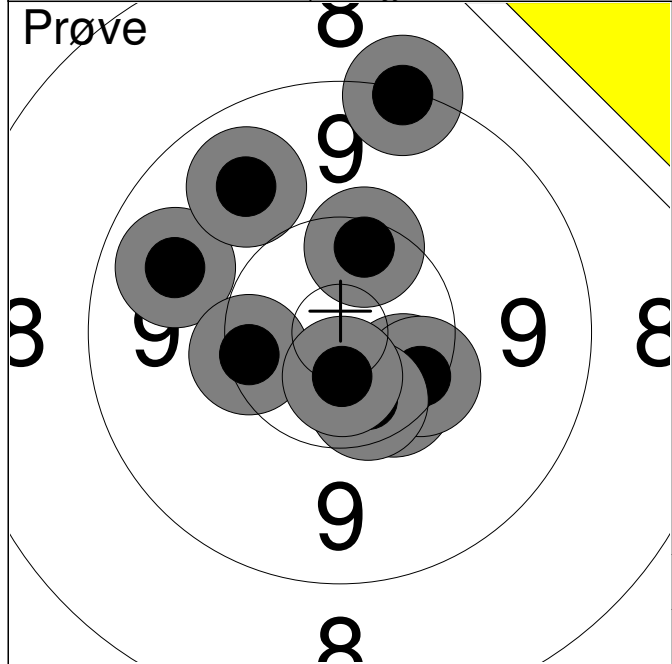

1:	9.2	↑
2:	10.3	↑
3:	9.7	↑
4:	*10.4	↓
5:	10.4	↓
6:	10.3	↓
7:	*10.5	↓
8:	9.8	↑
9:	10.3	←
10:	*10.7	↓
Serie		101.6
Total		396.0

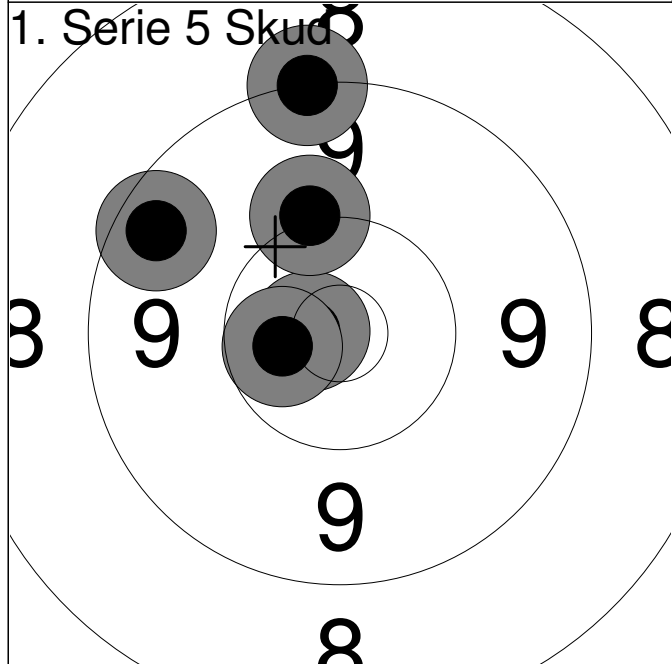

1:	*10.7	←
2:	10.1	↑
3:	9.2	↑
4:	*10.5	←
5:	9.5	↑
Serie		50.0
Total		446.0

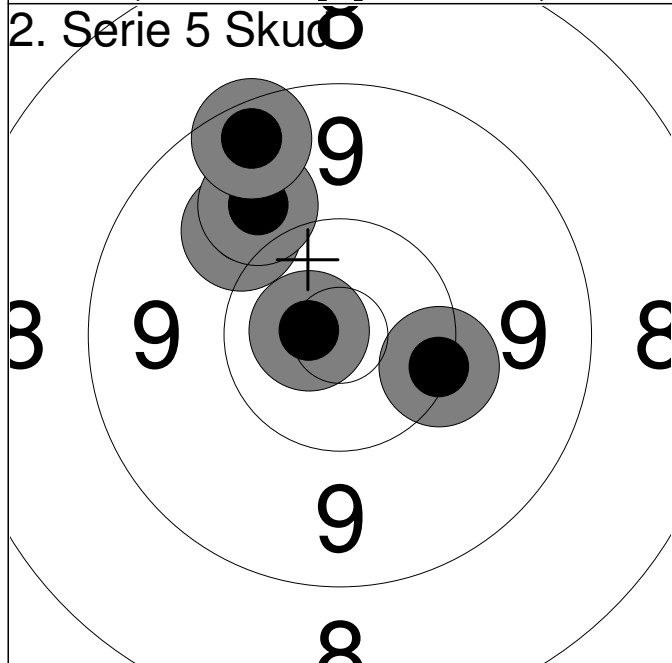

1:	10.0	↑
2:	*10.7	←
3:	10.2	↓
4:	9.9	↑
5:	9.4	↑
Serie		50.2
Total		496.2

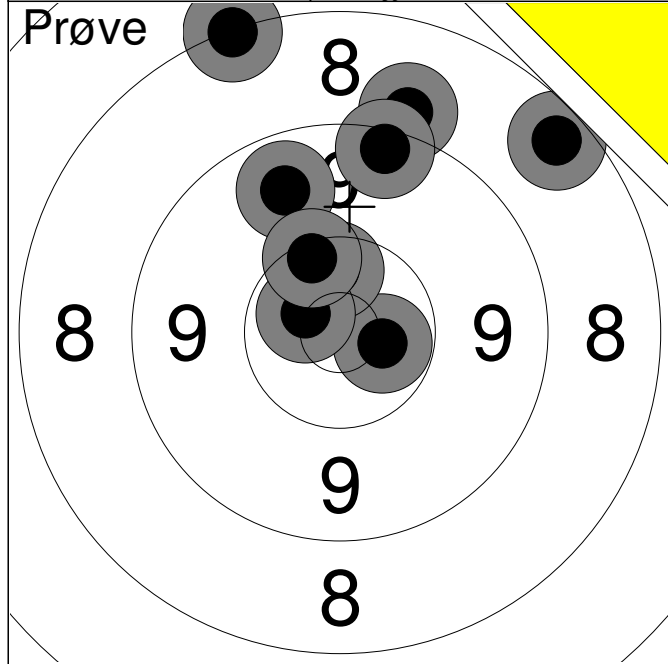

1:	8.5	↗
2:	9.7	↖
3:	9.0	↗
4:	8.2	↖
5:	9.3	↗
6:	*10.6	→
7:	*10.4	↖
8:	*10.6	↗
9:	10.3	↖

Serie	86.6
Total	396.0



1:	*10.4	↖
2:	*10.5	↘
3:	10.2	←
4:	10.1	↗
5:	*10.7	→

Serie	51.9
Total	447.9

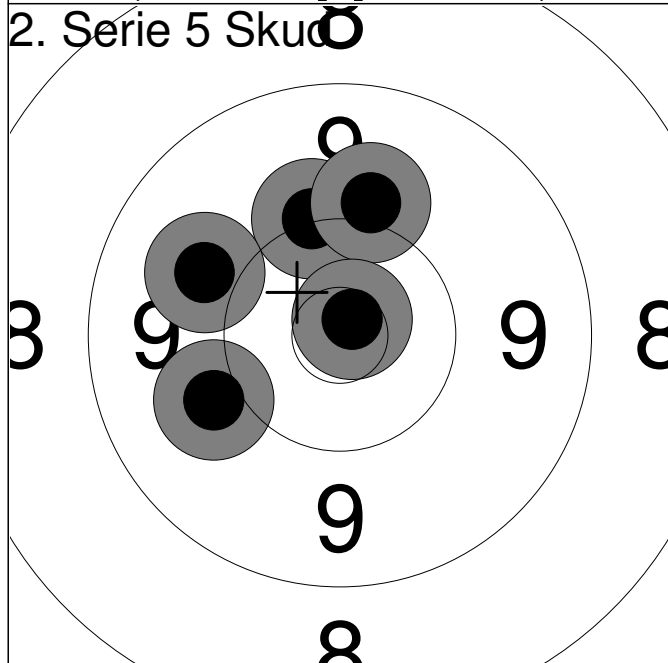

1:	10.1	↖
2:	9.9	↖
3:	10.0	↖
4:	*10.8	↗
5:	10.0	↖

Serie	50.8
Total	498.7

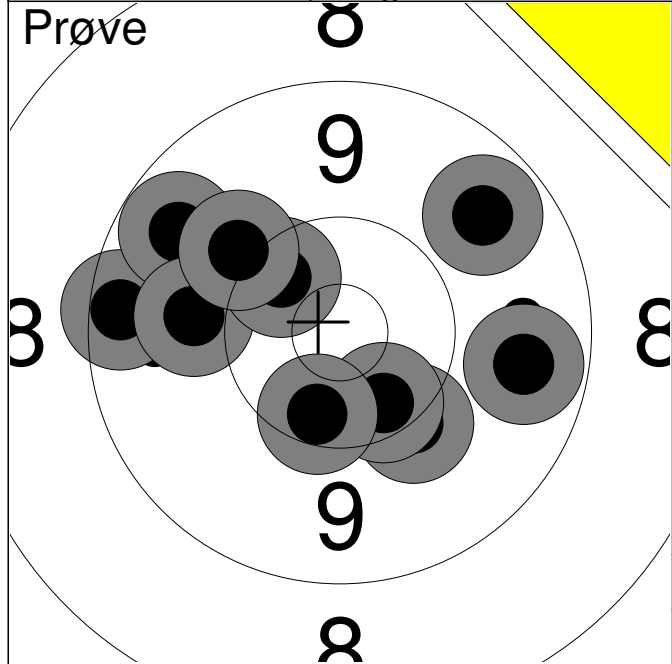

1:	9.7	↗
2:	9.4	↖
3:	9.6	↗
4:	10.2	↘
5:	10.4	↘
6:	9.7	→
7:	9.9	↖
8:	10.4	↗
9:	10.1	↗
10:	10.4	↘
Serie		99.8
Total		395.0

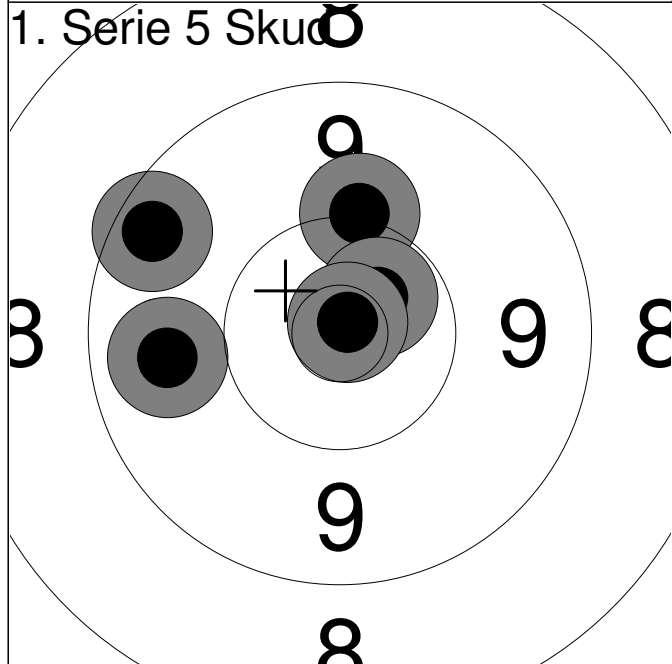

1:	10.1	↑
2:	9.7	↖
3:	*10.6	↗
4:	9.5	↖
5:	*10.9	↗
Serie		50.8
Total		445.8



1:	10.4	↗
2:	*10.5	→
3:	10.4	↗
4:	10.3	↗
5:	9.9	↖
Serie		51.5
Total		497.3

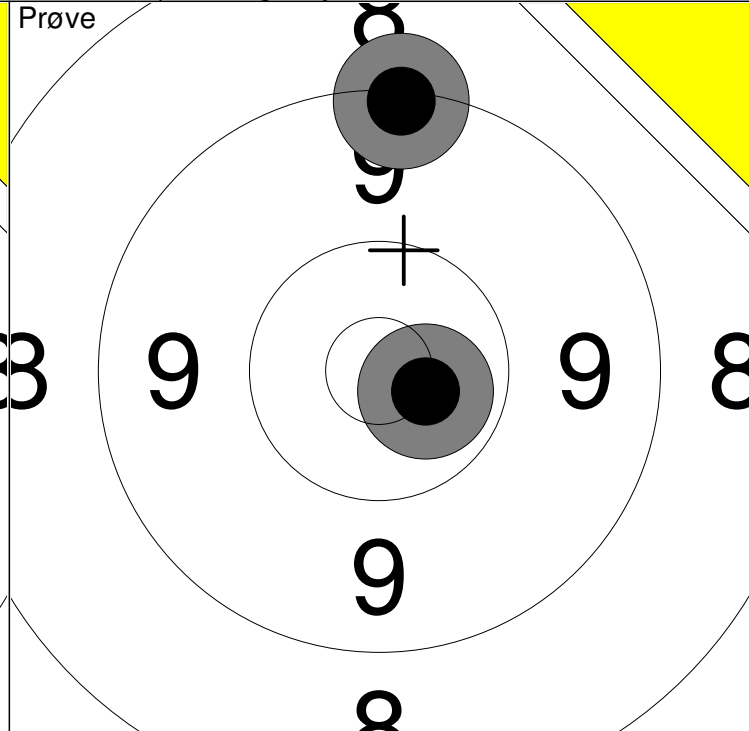
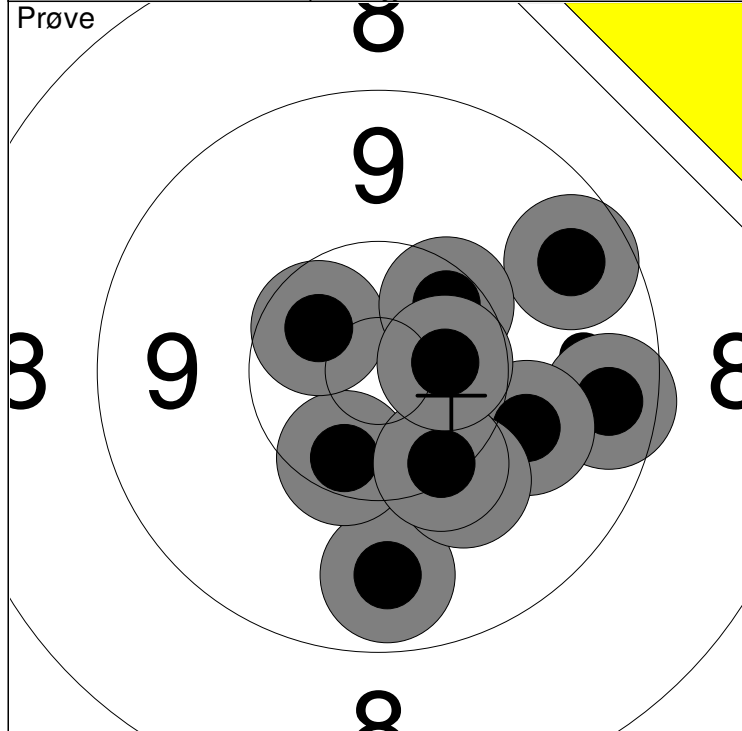

1: 9.5 →	6: *10.5 ↖	Serie 101.0
2: 9.7 ↓	7: 9.6 ↗	
3: 10.0 →	8: 10.3 ↓	Total 395.0
4: 10.4 ↓	9: 10.4 ↗	
5: 10.1 ↓	10: *10.5 →	

11: *10.6 →	Serie 19.8
12: 9.2 ↑	
Total 395.0	

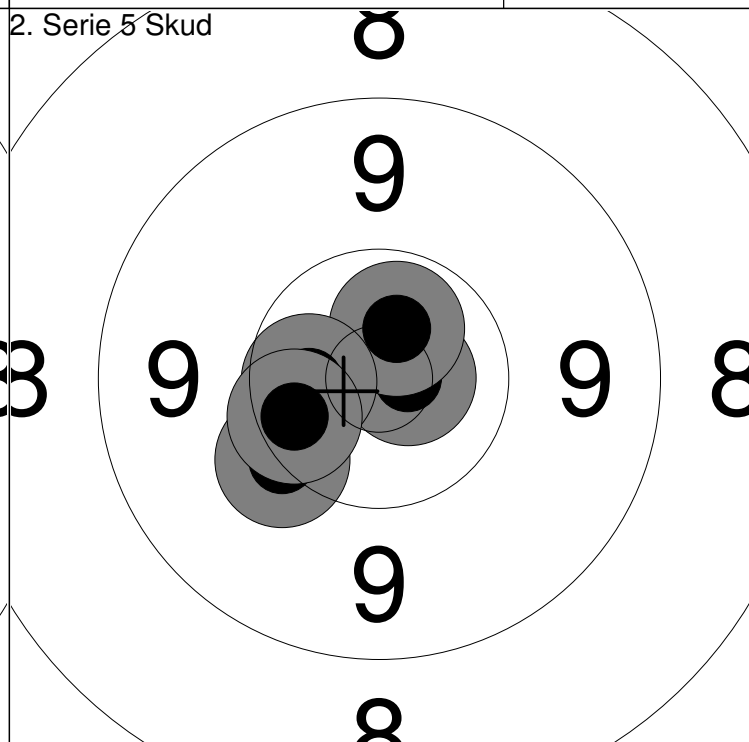
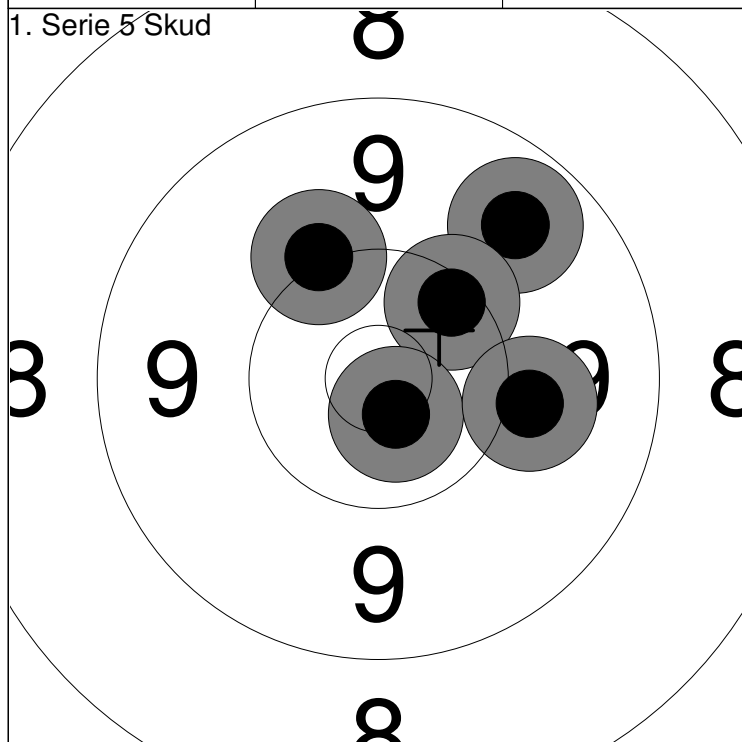

1: 9.7 ↗	Serie 50.8
2: 10.3 ↗	
3: *10.7 ↓	Total 445.8
4: 10.0 →	
5: 10.1 ↗	

1: 10.2 ↙	Serie 52.5
2: *10.8 →	
3: *10.6 ↑	Total 498.3
4: *10.5 ←	
5: 10.4 ↙	

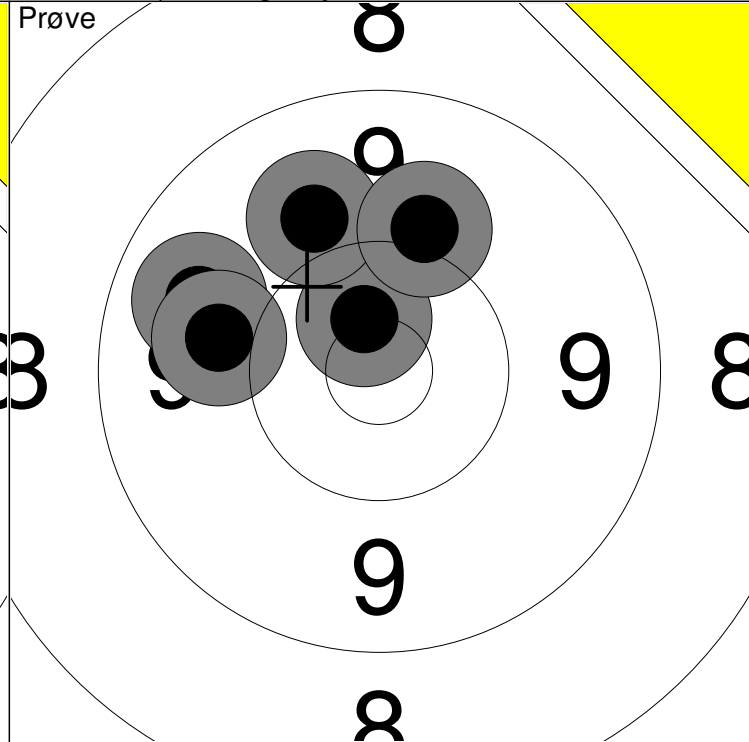
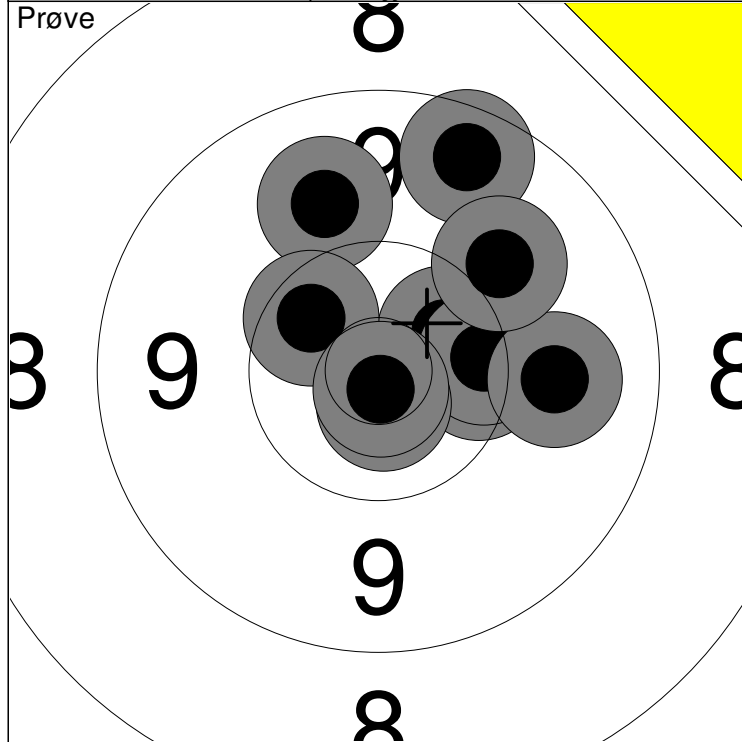

1: 9.5 ↗	6: 9.9 ↗	Serie 102.3
2: 10.3 →	7: 9.9 →	
3: *10.5 ↗	8: 10.0 ↗	Total 395.0
4: 10.3 →	9: *10.4 ↖	
5: *10.7 ↓	10: *10.8 ↓	

11: 9.8 ↖	Serie 50.3
12: *10.6 ↗	
13: 10.0 ↖	Total 395.0
14: 9.9 ↗	
15: 10.0 ↗	

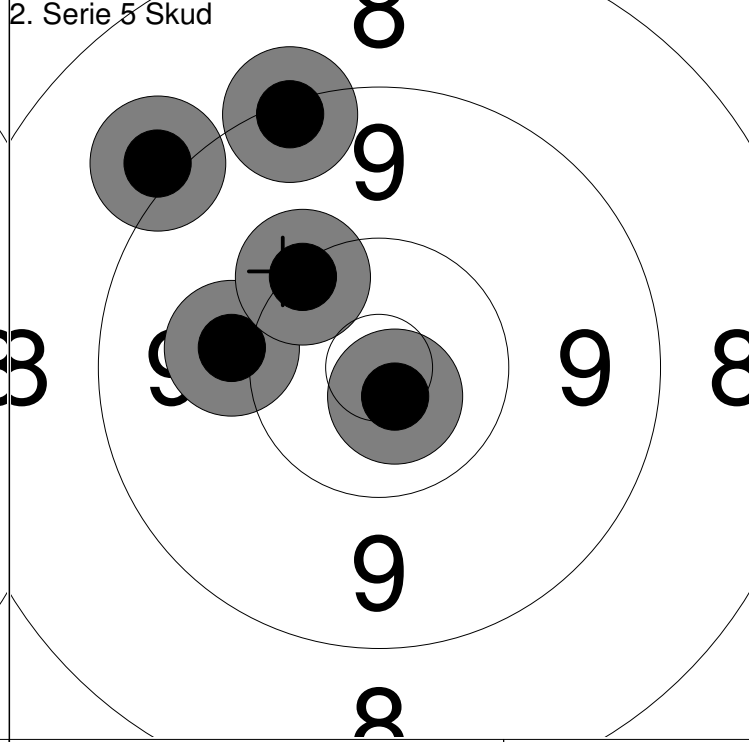
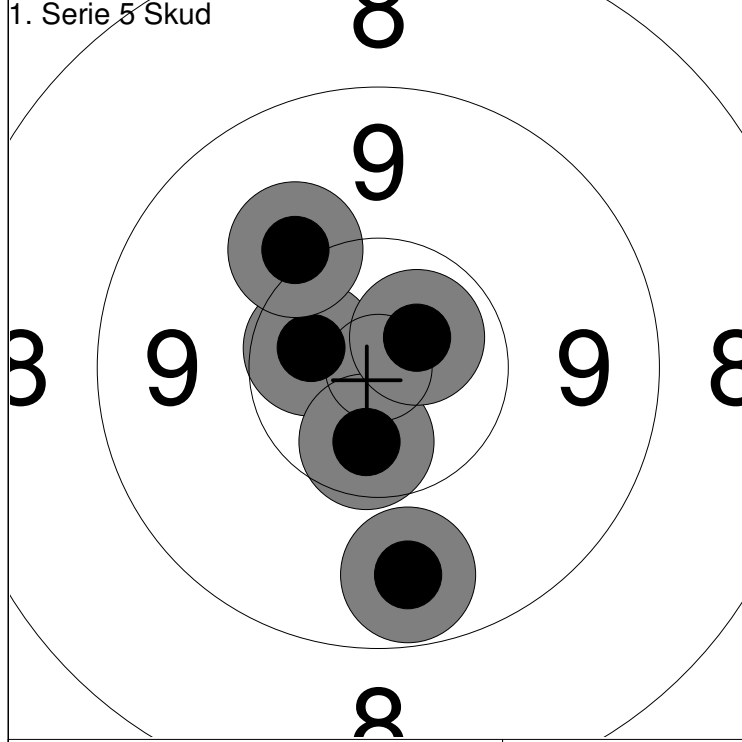

1: 9.6 ↓	Serie 51.4
2: *10.5 ↖	
3: *10.5 ↓	Total 446.4
4: 10.1 ↖	
5: *10.7 ↗	

1: 9.0 ↖	Serie 49.3
2: 10.0 ↖	
3: 9.3 ↗	Total 495.7
4: 10.2 ↗	
5: *10.8 ↓	

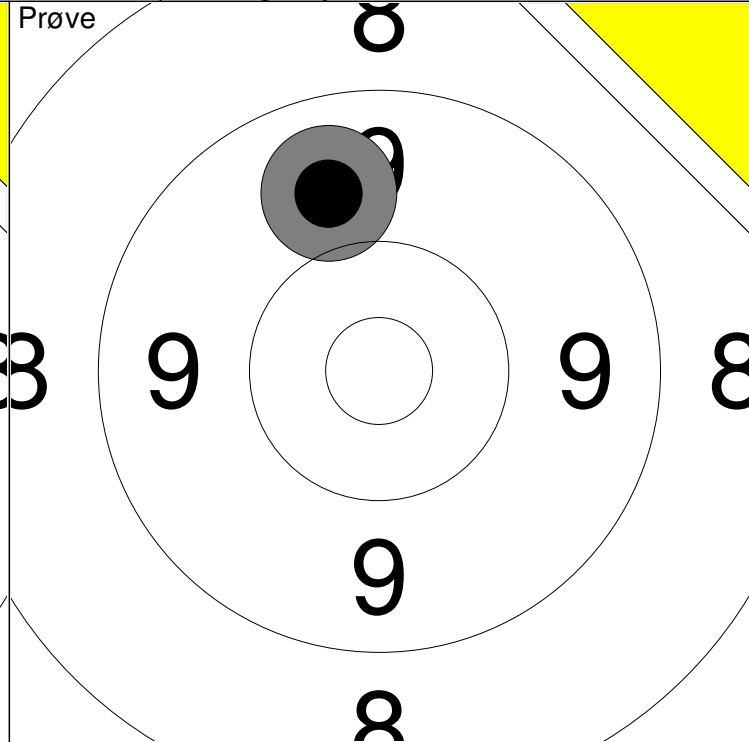
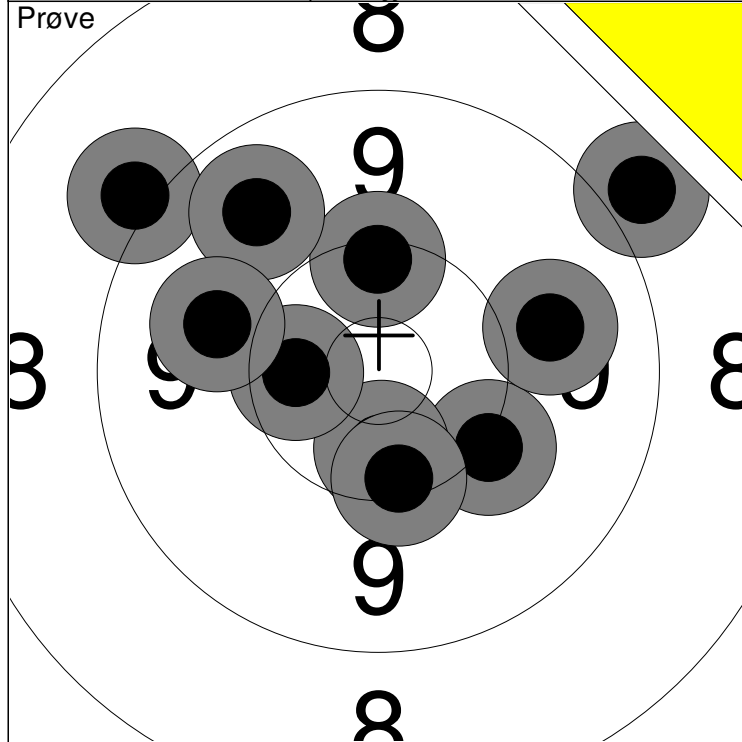

1: 8.9 ↗	6: 9.9 →	Serie	99.1
2: 10.1 ↘	7: 9.1 ↖		
3: *10.5 ↓	8: 9.7 ↗	Total	395.0
4: 10.3 ↑	9: *10.4 ←		
5: 10.3 ↓	10: 9.9 ←		

11: 9.8 ↑	Serie	9.8
	Total	395.0

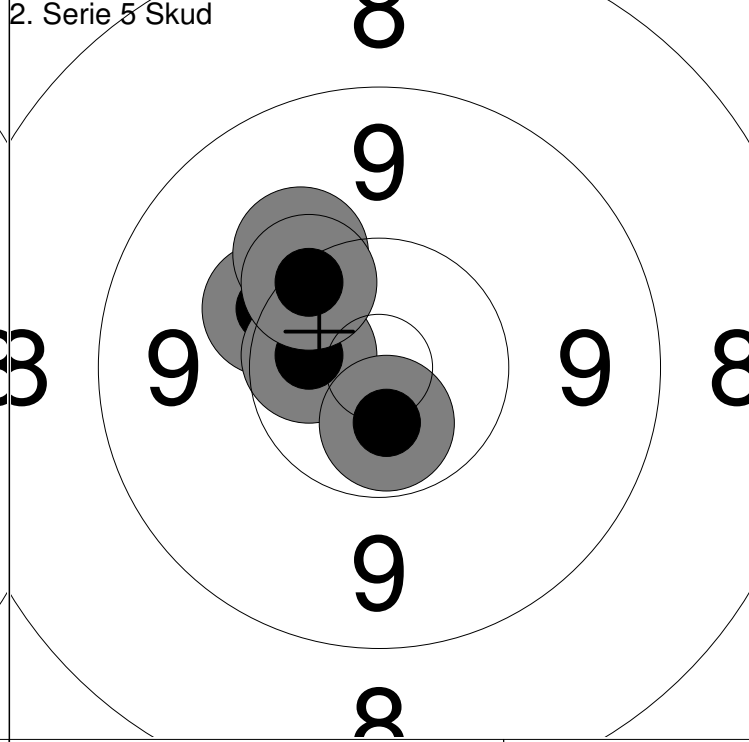
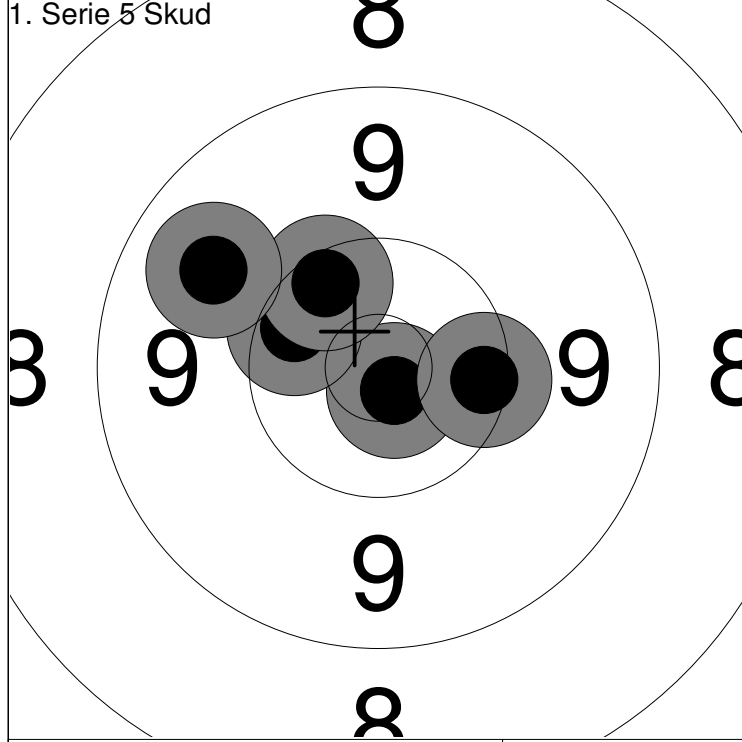

1: *10.8 ↓	Serie	51.6
2: 10.4 ↖		
3: 10.3 →	Total	446.6
4: 10.3 ↗		
5: 9.8 ↖		

1: 10.2 ↖	Serie	51.7
2: *10.5 ←		
3: 10.1 ↗	Total	498.3
4: 10.3 ↗		
5: *10.6 ↓		

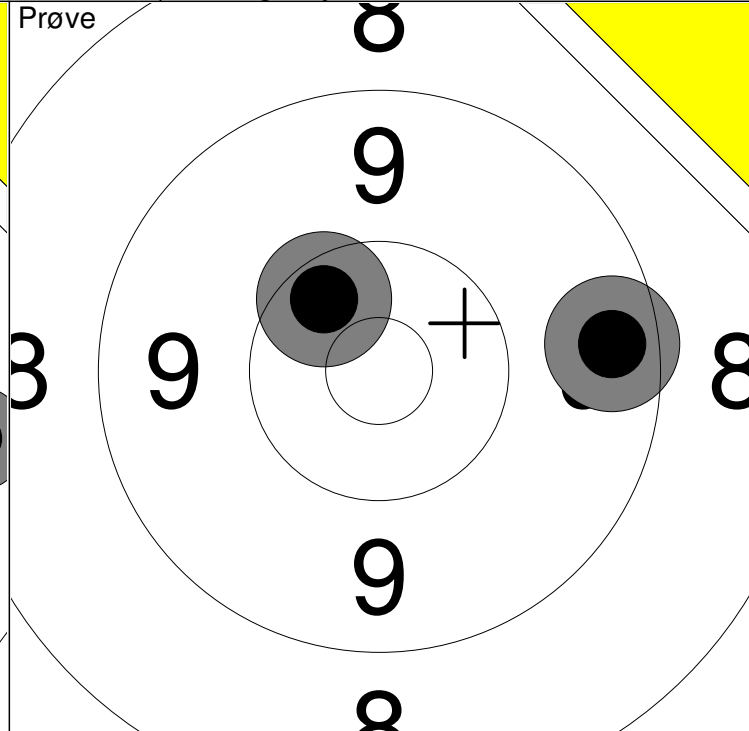
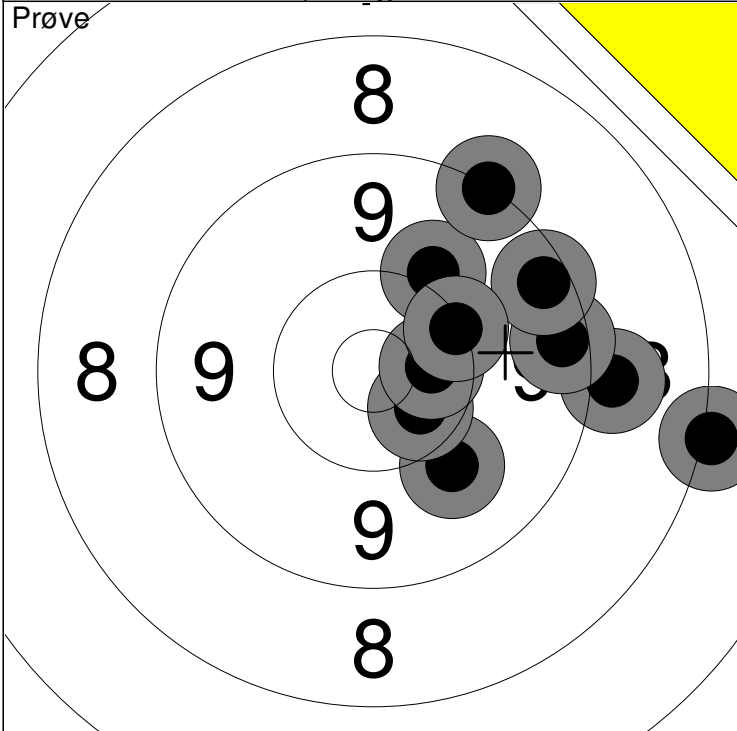

1: 9.0 →	6: 10.0 ↗	Serie	96.3
2: 9.4 →	7: *10.5 ↘		
3: 8.1 →	8: *10.5 →	Total	395.0
4: 10.0 ↘	9: 10.2 ↗		
5: 9.4 ↗	10: 9.2 ↗		

11: 9.5 →	Serie	19.9
12: 10.4 ↖		
Total		395.0

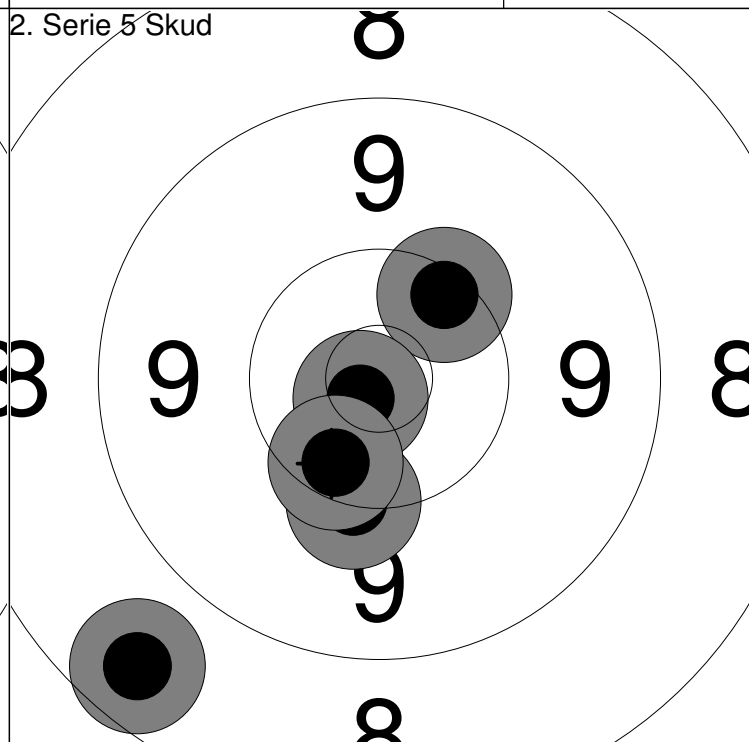
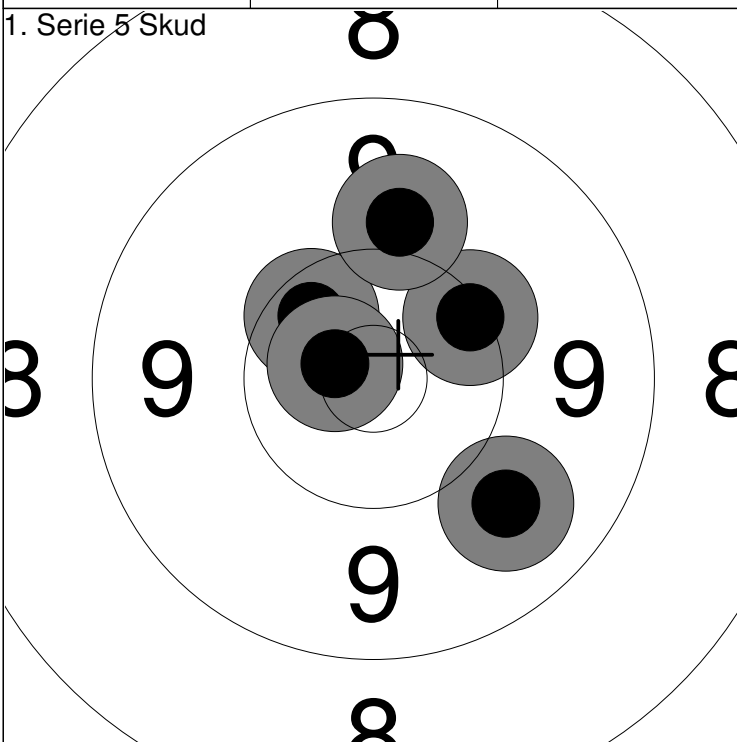

1: 9.8 ↘	Serie	51.2
2: *10.4 ↖		
3: 10.3 ↗	Total	446.2
4: 10.0 ↗		
5: *10.7 ↖		

1: 10.3 ↗	Serie	50.3
2: 10.2 ↘		
3: *10.8 ↘	Total	496.5
4: 8.6 ↘		
5: 10.4 ↘		